

Klemmen, Tupferzangen, Gefäßclips
Forceps, Cotton Swab Forceps, Vascular Clips
Pinzas hemostáticas, Pinzas para tampones,
Clips vasculares
Pinces hémostatiques, Pinces à tampons,
Clips vasculaires
Pinze emostatiche, Pinze per tamponi, Serrafini

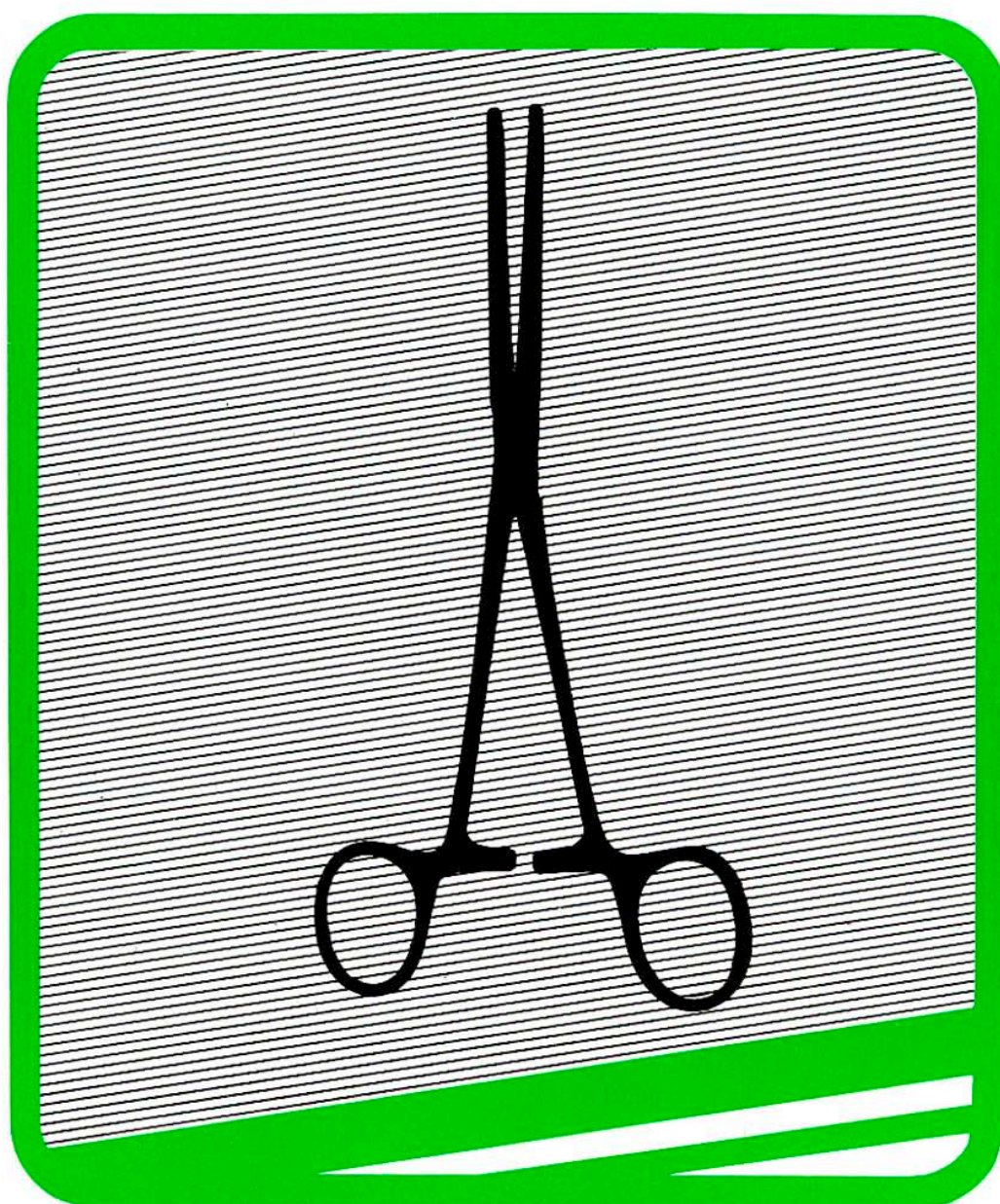

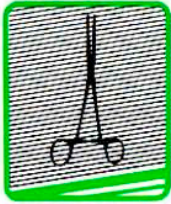

**Arterienklemmen
Hemostatic Forceps
Pinzas hemostáticas
Pinces hémostatiques
Pinze emostatiche**

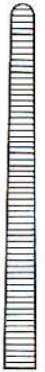

gerade
straight
rectas
droites
rette

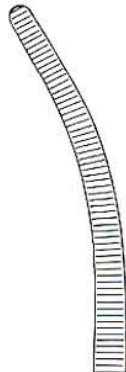
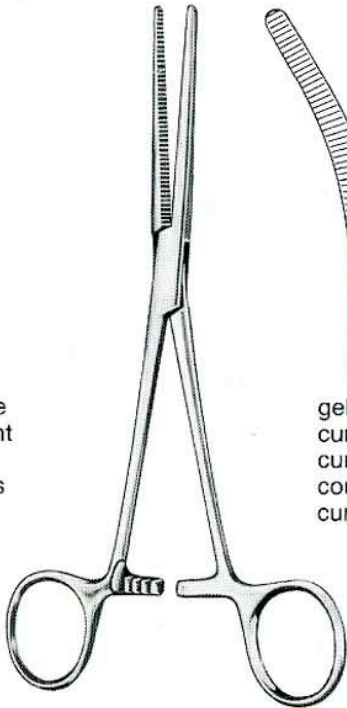

gebogen
curved
curvas
courbes
curve



gerade
straight
rectas
droites
rette

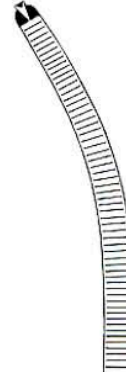
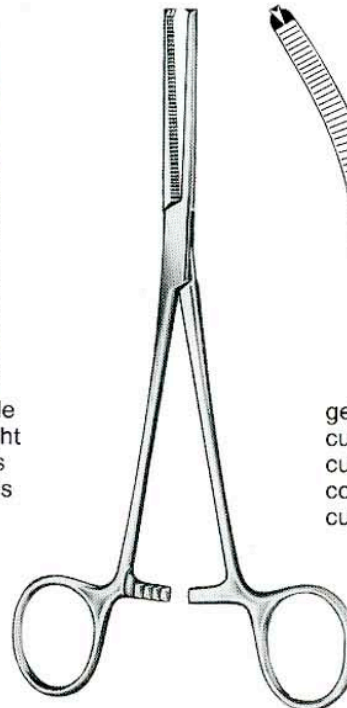

gebogen
curved
curvas
courbes
curve

Rochester-Péan		cm	in	Ochsner-Kocher	
RU 3000-13	RU 3001-13	13	5	RU 3010-13	RU 3011-13
RU 3000-14	RU 3001-14	14	5 1/2	RU 3010-14	RU 3011-14
RU 3000-16	RU 3001-16	16	6 1/4	RU 3010-16	RU 3011-16
RU 3000-18	RU 3001-18	18	7	RU 3010-18	RU 3011-18
RU 3000-20	RU 3001-20	20	8	RU 3010-20	RU 3011-20
RU 3000-22	RU 3001-22	22	8 3/4	RU 3010-22	RU 3011-22
RU 3000-24	RU 3001-24	24	9 1/2	RU 3010-24	RU 3011-24
RU 3000-26	RU 3001-26	26	10 1/4	RU 3010-26	RU 3011-26
RU 3000-30	RU 3001-30	30	12	RU 3010-30	RU 3011-30



gerade
straight
rectas
droites
rette



gebogen
curved
curvas
courbes
curve

fein
fine
finas
fines
fini



gerade
straight
rectas
droites
rette



gebogen
curved
curvas
courbes
curve

Péan		cm	in	Kocher	
RU 3020-13	RU 3021-13	13	5	RU 3030-13	RU 3031-13
RU 3020-14	RU 3021-14	14	5 1/2	RU 3030-14	RU 3031-14
RU 3020-16	RU 3021-16	16	6 1/4	RU 3030-16	RU 3031-16



Arterienklemmen
 Hemostatic Forceps
 Pinzas hemostáticas
 Pinces hémostatiques
 Pinze emostatiche

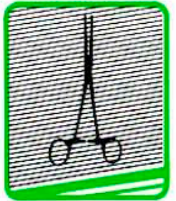

Kelly
 14 cm/5 1/2"

Kelly-Rankin
 16 cm/6 1/4"



RU 3050-14



RU 3051-14

14 cm/5 1/2"



RU 3050-16



RU 3051-16

16 cm/6 1/4"



Crile
 14 cm/5 1/2"

Crile-Rankin
 16 cm/6 1/4"



RU 3070-14



RU 3071-14

14 cm/5 1/2"



RU 3070-16



RU 3071-16

16 cm/6 1/4"



RU 3072-14



RU 3073-14



Baby-Crile
 14 cm/5 1/2"

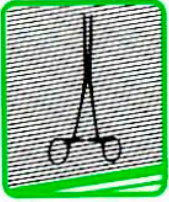

Arterienklemmen
 Hemostatic Forceps
 Pinzas hemostáticas
 Pinces hémostatiques
 Pinze emostatiche

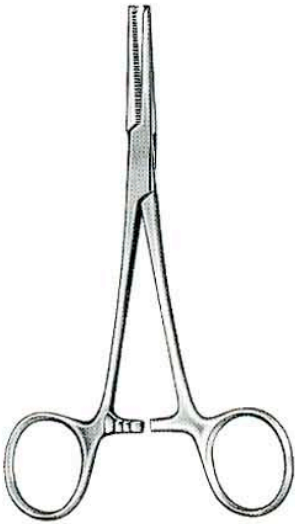

Crile
 14 cm/5 1/2"

Crile-Rankin
 16 cm/6 1/4"

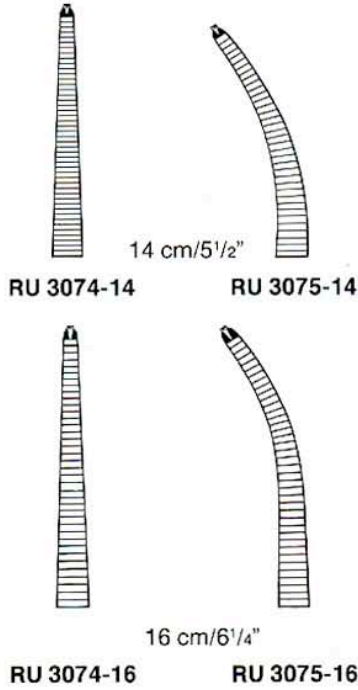

Baby-Crile
 14 cm/5 1/2"

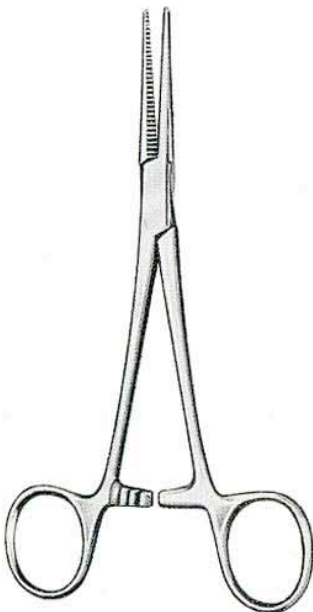
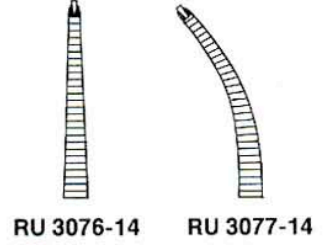

Coller-Crile

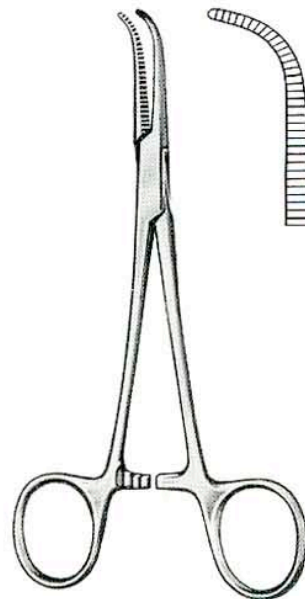
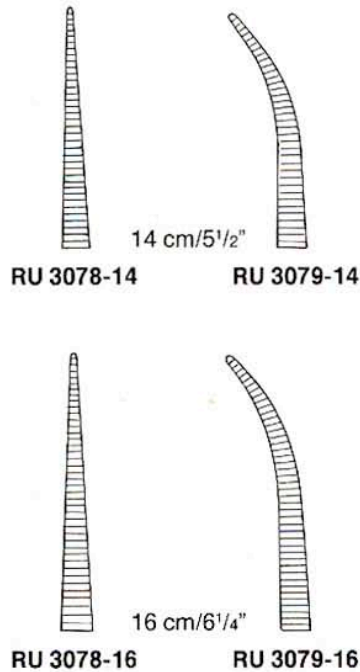

Coller-Crile
 16 cm/6 1/4"
 RU 3079-20/01



Arterienklemmen
Hemostatic Forceps
Pinzas hemostáticas
Pinces hémostatiques
Pinze emostatiche

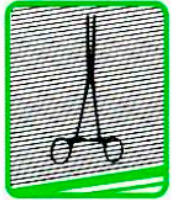

Leriche
 15 cm/6"



RU 3080-15



RU 3081-15



RU 3082-15



RU 3083-15



Providence
 14 cm/5 1/2"



RU 3090-14

Ligaturklemme, glatt
 Ligature forceps, smooth
 Pinzas ligaduras, lisas
 Pince à ligature, lisse
 Pinze per legature, lisce



RU 3091-14

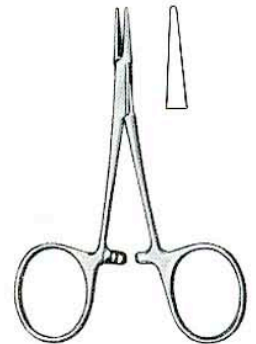

9,5 cm/3 3/4"
 RU 3097-09



Halsted-Mosquito
 12 cm/4 3/4"
 14 cm/5 1/2"



RU 3100-12
 RU 3100-14



RU 3101-12
 RU 3101-14



RU 3110-12
 RU 3110-14



RU 3111-12
 RU 3111-14



Halsted-Mosquito
 18 cm/7"
 21 cm/8 1/4"



RU 3100-18
 RU 3100-21



RU 3101-18
 RU 3101-21



RU 3110-18
 RU 3110-21



RU 3111-18
 RU 3111-21

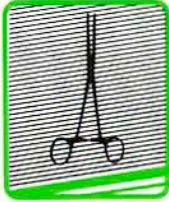

**Arterienklemmen
Hemostatic Forceps
Pinzas hemostáticas
Pinces hémostatiques
Pinze emostatiche**

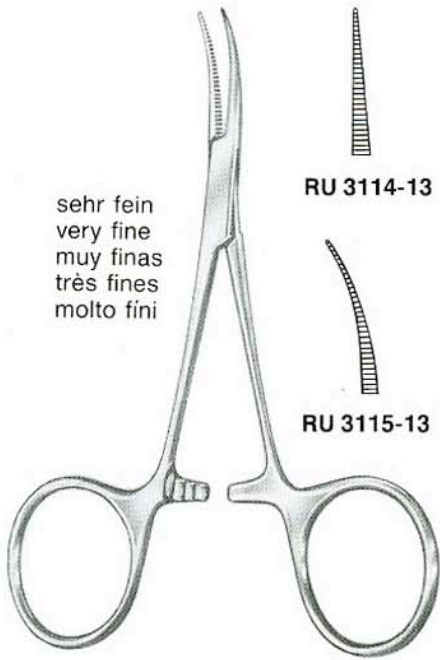

sehr fein
very fine
muy finas
très fines
molto fini

RU 3114-13

RU 3115-13

Jacobson-Halsted
13 cm/5"

Vasektomie Fixierklemme
Vasectomy Fixation Forceps
Pinza de fijación para vasectomia
Pince de fixation pour vasectomie
Pinza di fissaggio per vasectomia



14 cm/5½"
RU 3118-01

Vasektomie Präparierklemme
Dissecting Forceps for vasectomy
Pinza de disección para vasectomia
Pince a dissection pour vasectomie
Pinza per preparazione per vasectomia

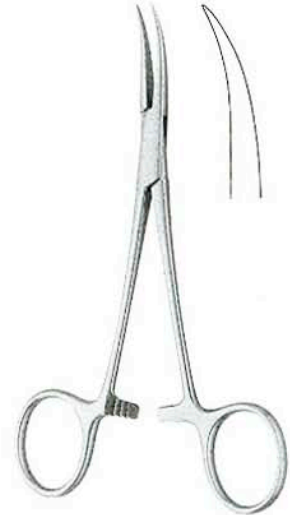

13 cm/5"
RU 3118-02

Maul kreuzgerieft
Cross serrations
Bocas con estrías cruzadas
Mors à rainures croisées
Morsi a zigrinature incrociate



RU 3120-10
RU 3120-12

RU 3122-10
RU 3122-12

RU 3121-10
RU 3121-12

RU 3123-10
RU 3123-12

Micro-Mosquito
10 cm/4"
12 cm/4¾"

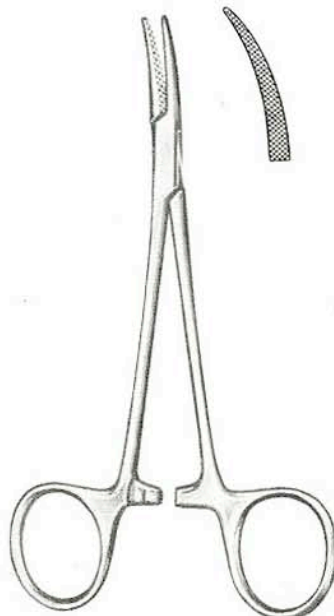

12 cm/4¾"
RU 3137-12



RU 3140-10

RU 3141-10

RU 3142-10

RU 3143-10

Hartmann
10 cm/4"



Bulldogklemmen, Arterienklemmen
Bulldog Clamps, Hemostatic Forceps
Clamps Bulldog, Pinzas hemostáticas
Clamps Bulldog, Pincas hémostatiques
Pinze Bulldog, Pinze emostatiche

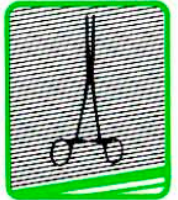

Dieffenbach
 3,5 cm/1 1/2"
 RU 3144-03
 5 cm/2"
 RU 3144-05



Dieffenbach
 3,5 cm/1 1/2"
 RU 3145-03
 5 cm/2"
 RU 3145-05

gerade
 straight
 rectas
 droits
 rette

RU 3146-00/01	38 mm/1 1/2"
RU 3146-00/02	51 mm/2"
RU 3146-00/03	57 mm/2 1/4"
RU 3146-00/04	63 mm/2 1/2"
RU 3146-00/05	70 mm/2 3/4"
RU 3146-00/06	75 mm/3"
RU 3146-00/07	90 mm/3 1/2"

für Bulldogklemmen
 for Bulldog clamps
 para clamps Bulldog
 pour clamps Bulldog
 per pinze Bulldog



Dieffenbach
 6 cm/2 1/2"
 RU 3144-06



Dieffenbach
 6 cm/2 1/2"
 RU 3145-06

gebogen
 curved
 curvas
 courbes
 curve

RU 3146-01	38 mm/1 1/2"
RU 3146-02	51 mm/2"
RU 3146-03	57 mm/2 1/4"
RU 3146-04	63 mm/2 1/2"
RU 3146-05	70 mm/2 3/4"
RU 3146-06	75 mm/3"
RU 3146-07	90 mm/3 1/2"



Johns Hopkins



Johns Hopkins
 24,5 cm/9 3/4"
 RU 3146-50

Hämorrhoidalklemme
 Haemorrhoidal clamps
 Pinzas hemorroidales
 Pince hémorroïdale
 Pinze emorroidali

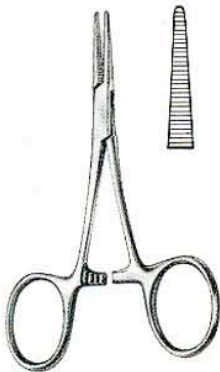

Carrel
 10 cm/4"
 RU 3147-10

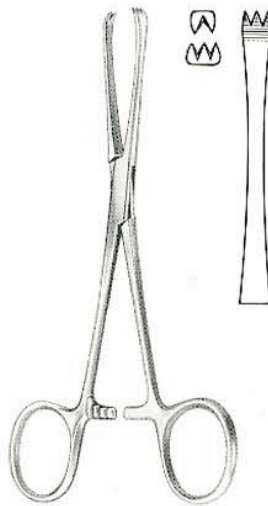

Chaput
 13 cm/5"
 RU 3148-13

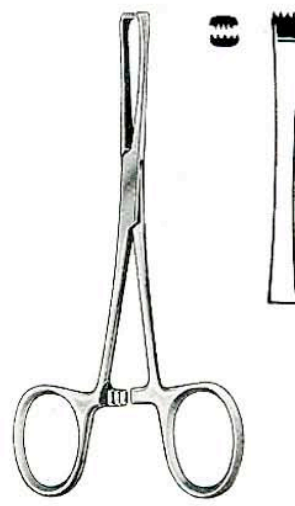

Tuffier
 13 cm/5"
 RU 3149-13

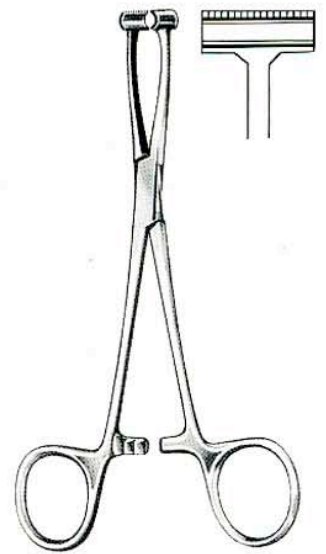

Pratt
 15 cm/6"
 RU 3150-15

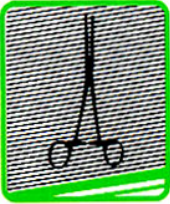

Arterienklemmen
Hemostatic Forceps
Pinzas hemostáticas
Pinces hémostatiques
Pinze emostatiche

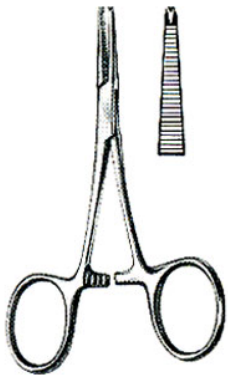

Terrier
10 cm/4"
RU 3151-10



Pennington
15 cm/6"
RU 3152-15
20 cm/8"
RU 3152-20

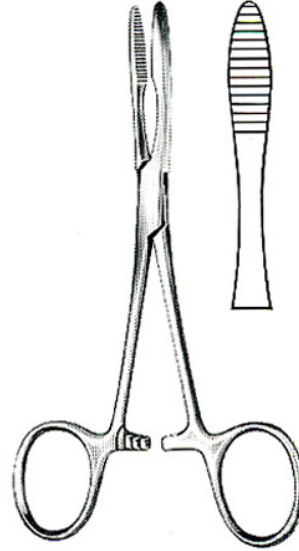

Péan
14 cm/5 1/2"
RU 3153-14
16 cm/6 1/4"
RU 3153-16

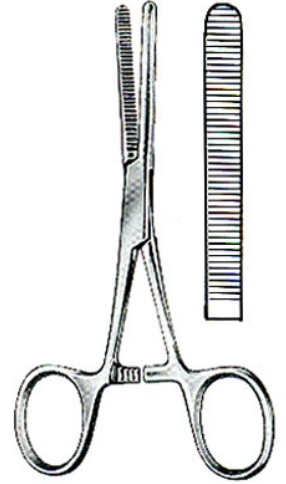

Péan
12,5 cm/5"
RU 3154-12

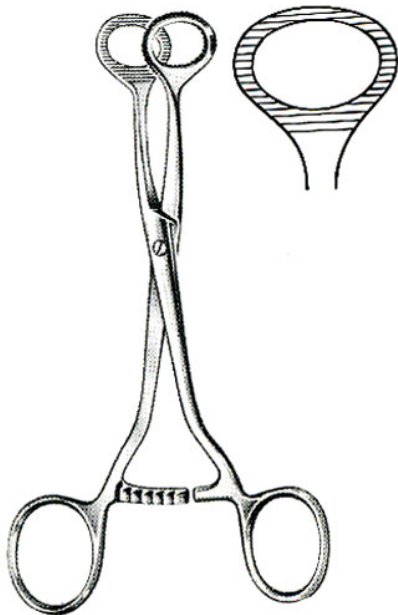

Collin
15,5 cm/6"
RU 3155-16

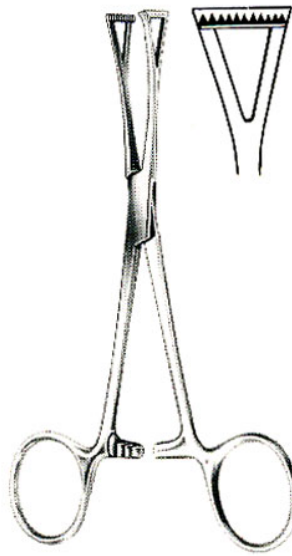

Collin
14 cm/5 1/2"
RU 3156-14



Collin
16,5 cm/6 1/2"
RU 3157-16



Arterienklemmen
 Hemostatic Forceps
 Pinzas hemostáticas
 Pincès hémostatiques
 Pinze emostatiche

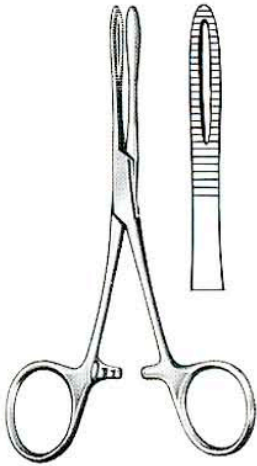
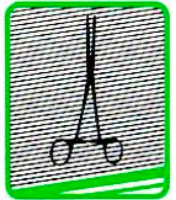

Krönlein
 13 cm/5"
 RU 3158-13

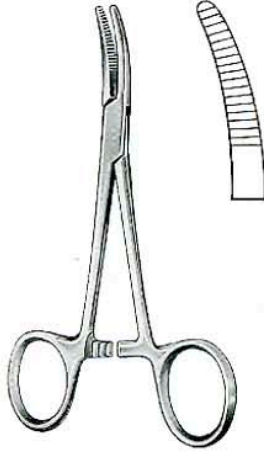

Dunhill
 13 cm/5"
 RU 3159-13

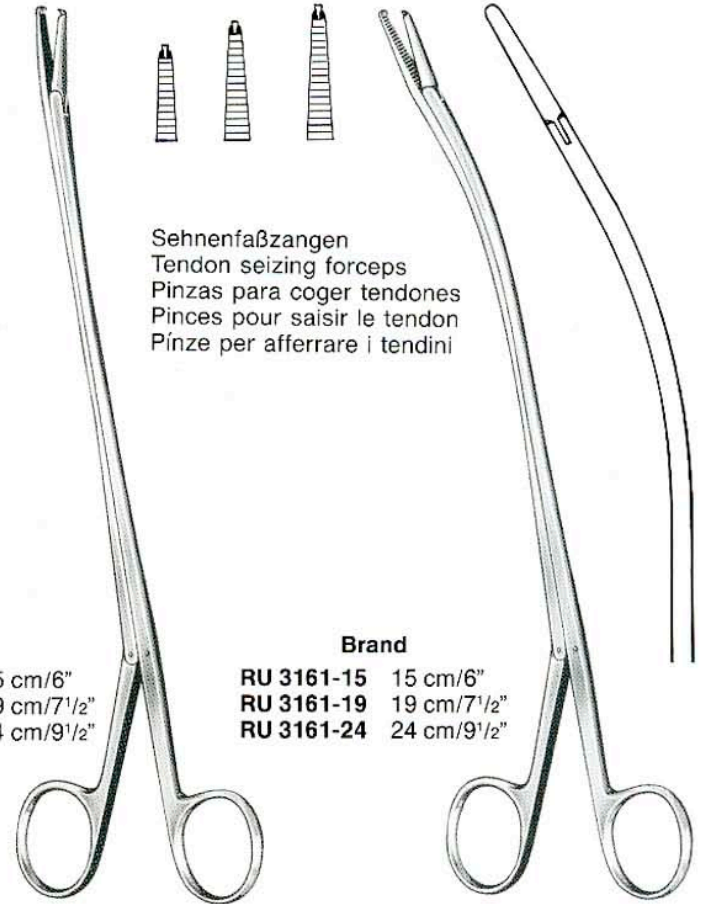

Sehnenfaßzangen
 Tendon seizing forceps
 Pinzas para coger tendones
 Pincès pour saisir le tendon
 Pinze per afferrare i tendini

Brand
 RU 3160-15 15 cm/6"
 RU 3160-19 19 cm/7½"
 RU 3160-24 24 cm/9½"

Brand
 RU 3161-15 15 cm/6"
 RU 3161-19 19 cm/7½"
 RU 3161-24 24 cm/9½"

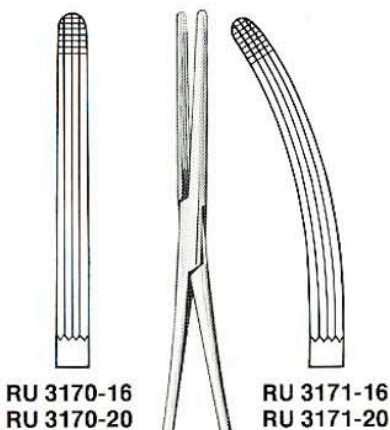

RU 3170-16
 RU 3170-20

RU 3171-16
 RU 3171-20

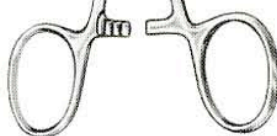

Rochester-Carmalt
 16 cm/6¼"
 20 cm/8"

seitwärts gebogen
 lateral curved
 curvas laterales
 courbes latérales
 curvate lateralmente



RU 3179-12

RU 3181-12

Mosquito-Dandy
 12 cm/4¾"

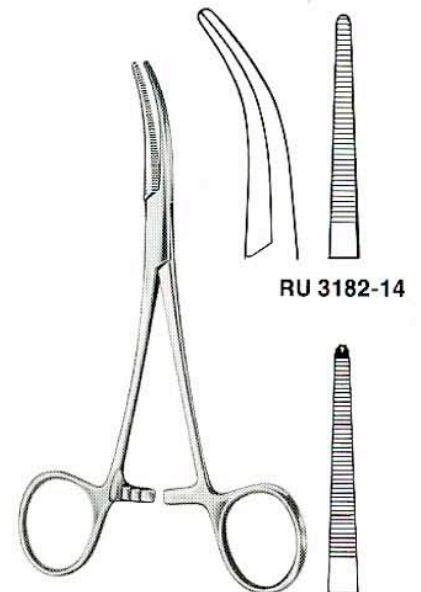

RU 3182-14

Dandy RU 3183-14
 14 cm/5½"

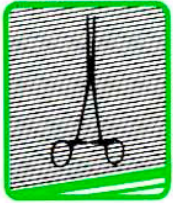

Arterienklemmen
Hemostatic Forceps
Pinzas hemostáticas
Pinces hémostatiques
Pinze emostatiche



Lovelace
15,5 cm/6"
RU 3185-15

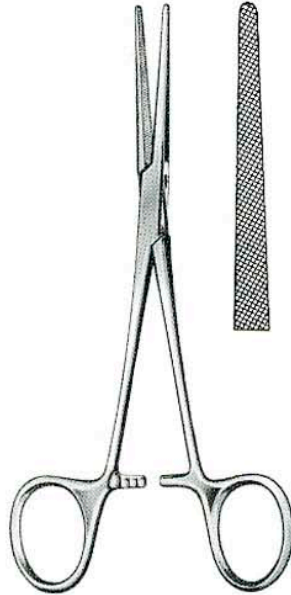

Dixon-Lovelace
16 cm/6 1/4"
RU 3186-16

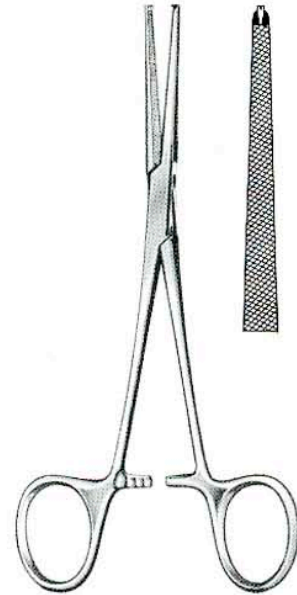

Dixon-Lovelace
16 cm/6 1/4"
RU 3187-16

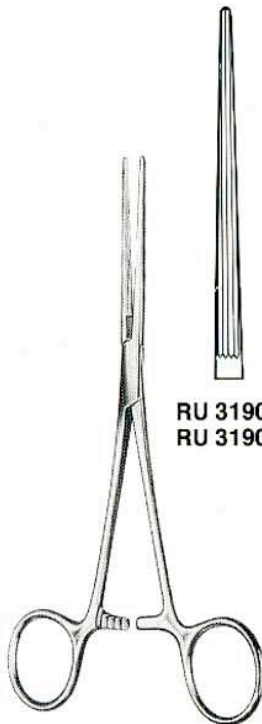

Bainbridge
15 cm/6"
18 cm/7"



RU 3190-15
RU 3190-18



RU 3191-15
RU 3191-18



Fuchsig
19 cm/7 1/2"
RU 3198-19



Arterienklemmen, Präparier- und Ligaturklemmen
Hemostatic Forceps, Dissecting- and Ligature Forceps
Pinzas hemostáticas, Pinzas para preparaciones y ligaduras
Pinces hémostatiques, Pinces à disséquer et à ligatures
Pinze emostatiche, Pinze per dissezione e legature

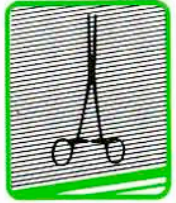

Adson
18,5 cm/7¹/₄"



RU 3200-18



RU 3201-18



RU 3202-18



RU 3203-18



Nissen
 RU 3204-18 18,5 cm/7¹/₄"
 RU 3204-22 22 cm/8³/₄"



Baby-Adson



14 cm/5¹/₂"
RU 3205-14

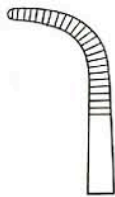

18 cm/7"
RU 3205-18

sehr fein
 very fine
 muy finas
 très fines
 molto fini

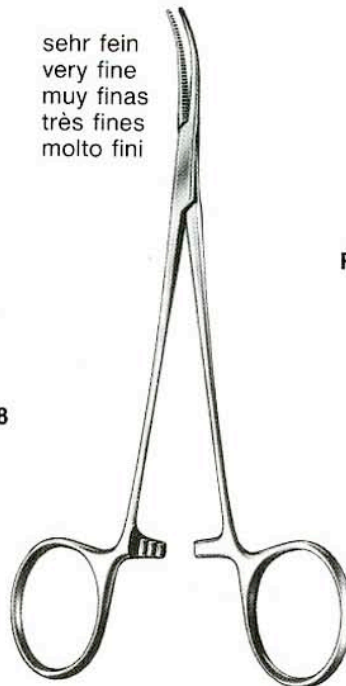

Jacobson-Adson
18 cm/7"



RU 3206-00



RU 3206-18

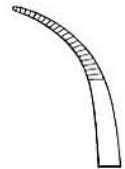

RU 3207-18

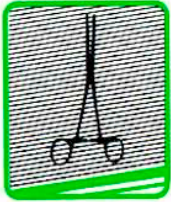

Arterienklemmen
Hemostatic Forceps
Pinzas hemostáticas
Pinces hémostatiques
Pinze emostatiche



Schnidt
 19 cm/7 1/2"

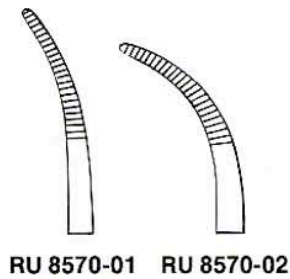

RU 8570-01 RU 8570-02

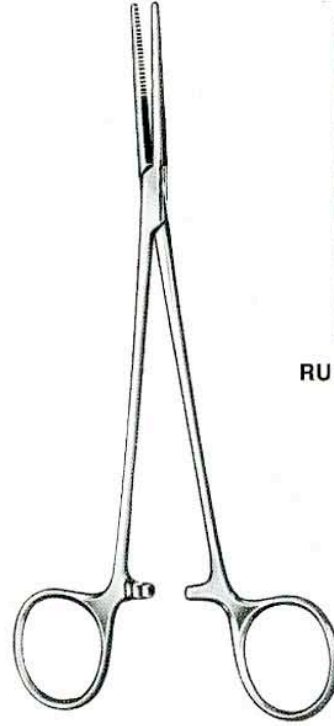

Birkett
 19 cm/7 1/2"

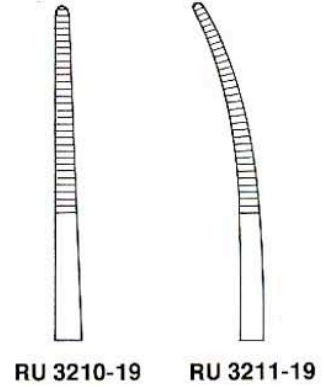

RU 3210-19 RU 3211-19



Bengolea

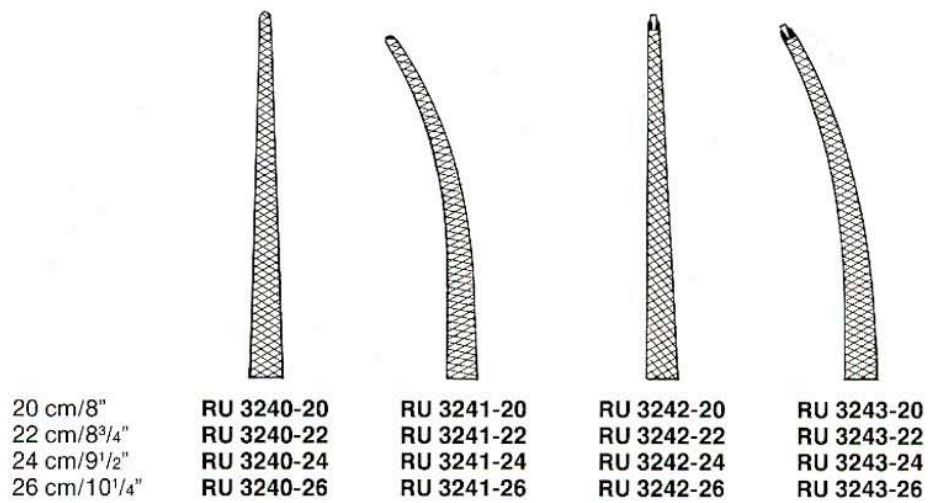

20 cm/8"	RU 3240-20	RU 3241-20	RU 3242-20	RU 3243-20
22 cm/8 3/4"	RU 3240-22	RU 3241-22	RU 3242-22	RU 3243-22
24 cm/9 1/2"	RU 3240-24	RU 3241-24	RU 3242-24	RU 3243-24
26 cm/10 1/4"	RU 3240-26	RU 3241-26	RU 3242-26	RU 3243-26



Arterienklemmen
Hemostatic Forceps
Pinzas hemostáticas
Pinces hémostatiques
Pinze emostatiche

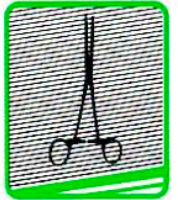

Bridge
 27 cm/10¹/₂"



RU 3246-27



RU 3247-27



Roberts
 22 cm/8³/₄"



RU 3250-22

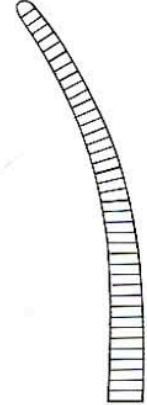

RU 3251-22



Kelly



19 cm/7¹/₂"

RU 3253-19/01



RU 3253-19/02



RU 3253-19/03

22 cm/8³/₄"

RU 3253-22/01

RU 3253-22/02

RU 3253-22/03

24 cm/9¹/₂"

RU 3253-24/01

RU 3253-24/02

RU 3253-24/03

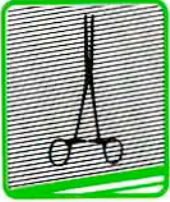

Arterienklemmen, Bronchusklemmen
Hemostatic Forceps, Bronchus Forceps
Pinzas hemostáticas, Pinzas-clamps bronquiales
Pinces hémostatiques, Pince-clamps à bronches
Pinze emostatiche, Pinze per bronchi

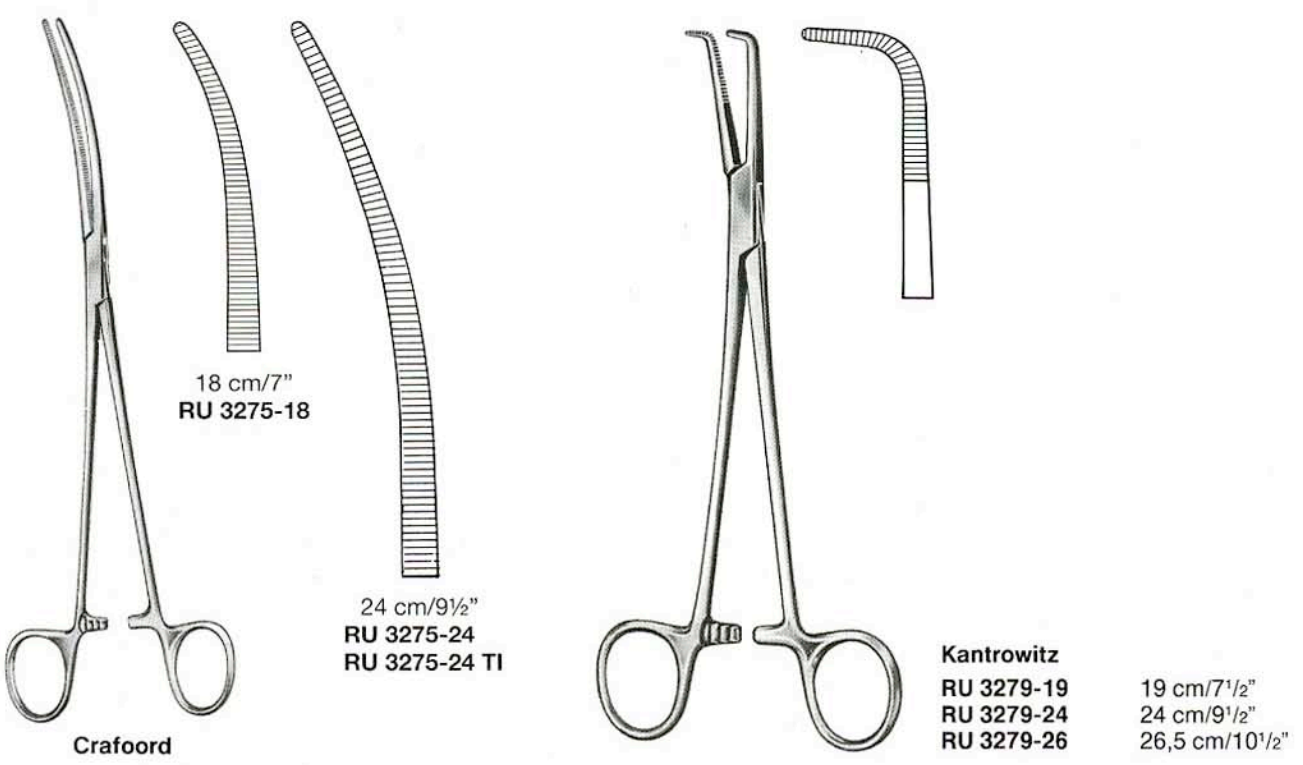
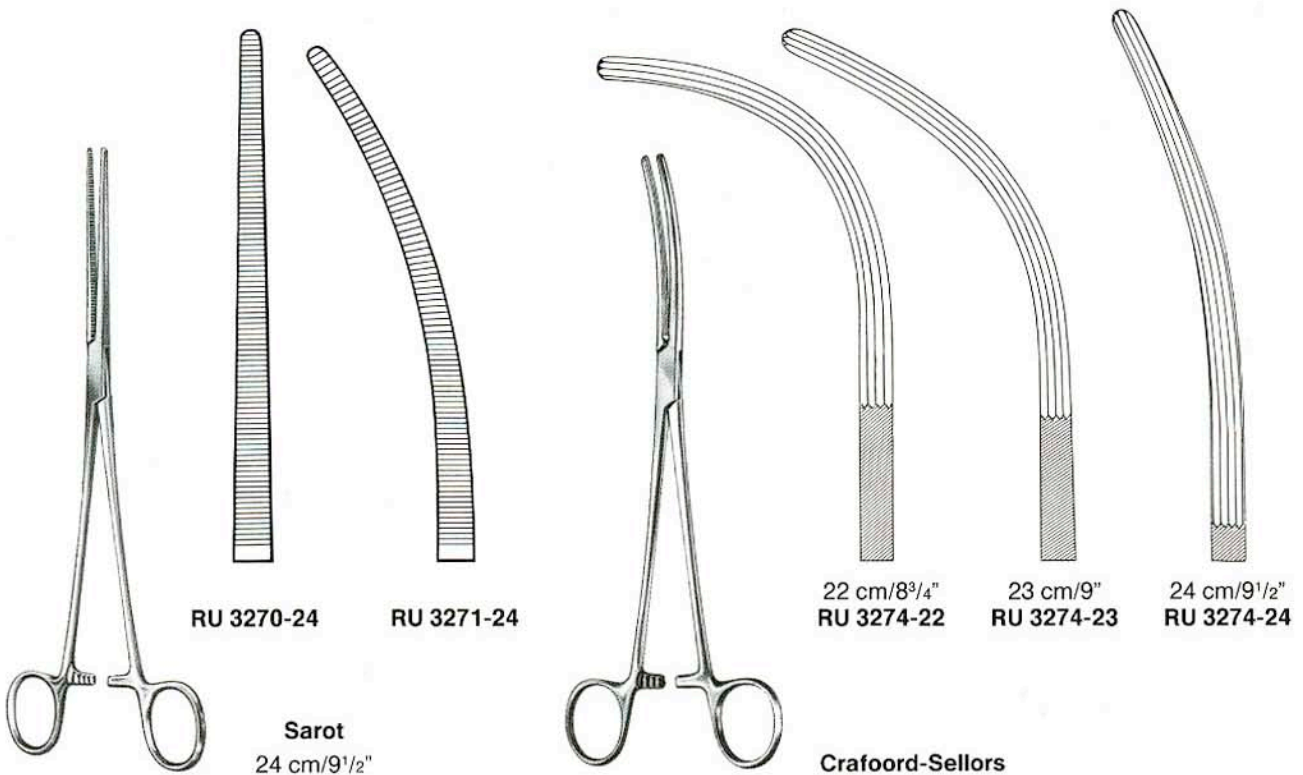



Präparier- und Ligaturklemmen
Dissecting and Ligature Forceps
Pinzas para preparaciones y ligaduras
Pinces à disséquer et à ligatures
Pinze per dissezione e legature

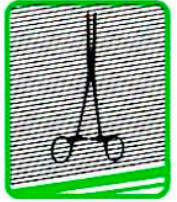

Rumel
23 cm/9"



RU 3280-01



RU 3280-02



RU 3280-03

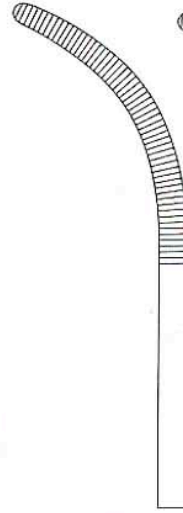

RU 3280-04

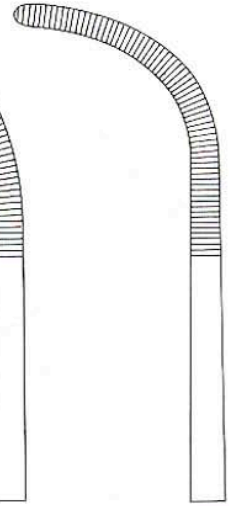

RU 3280-05

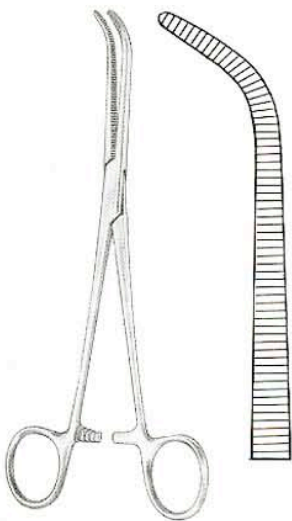

Johns Hopkins
20 cm/8"
RU 3285-20

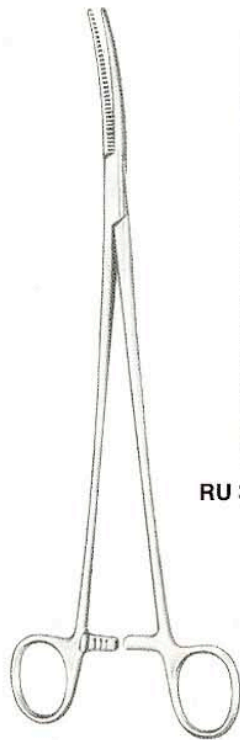

Zenker
29,5 cm/11 1/2"

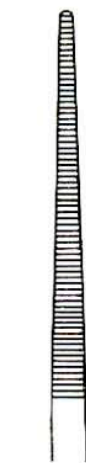

RU 3286-00



RU 3286-01

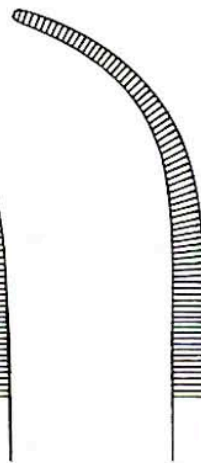

RU 3286-02

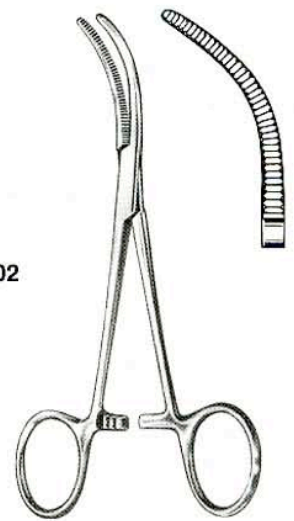

Baby-Overholt
13,5 cm/5 1/4"
RU 3289-14

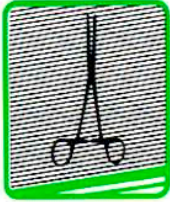

Präparier- und Ligaturklemmen
Dissecting and Ligature Forceps
Pinzas para preparaciones y ligaduras
Pinces à disséquer et à ligatures
Pinze per dissezione e legature

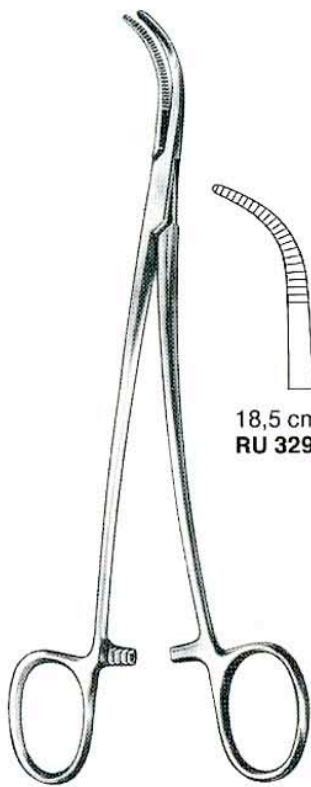

Overholt-S

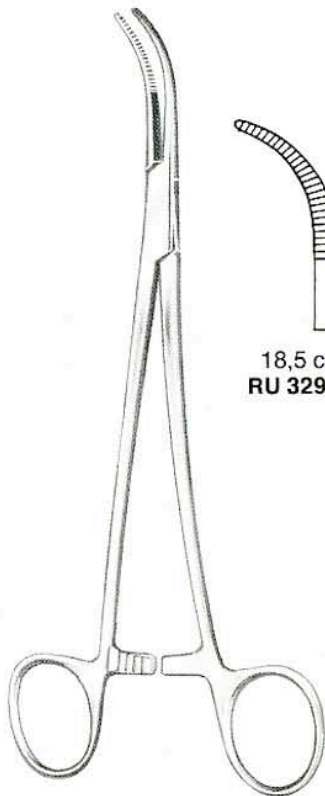
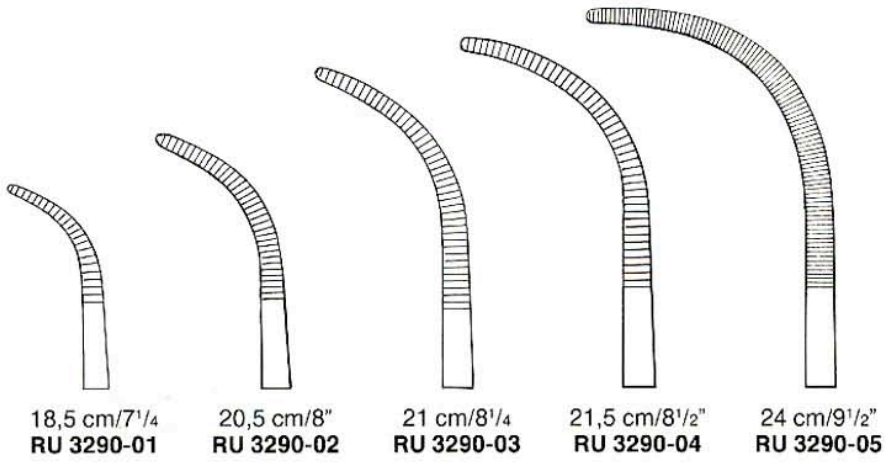

Overholt-Slim

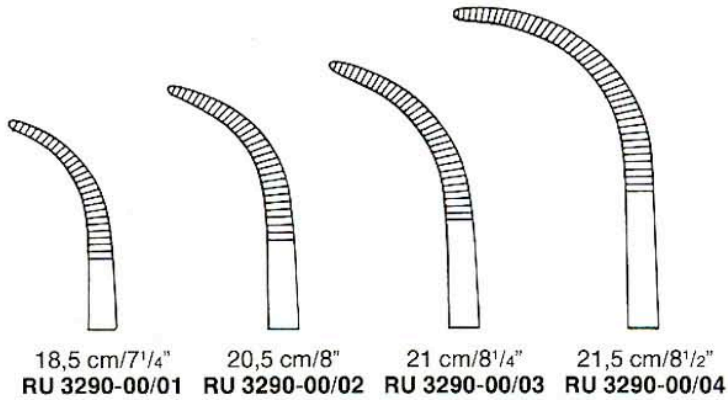



Präparier- und Ligaturklemmen
Dissecting and Ligature Forceps
Pinzas para preparaciones y ligaduras
Pinces à disséquer et à ligatures
Pinze per dissezione e legature

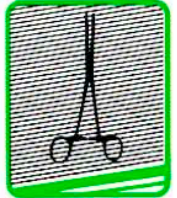

Overholt-Geissendörfer

21 cm/8¹/₄"
27 cm/10¹/₂"

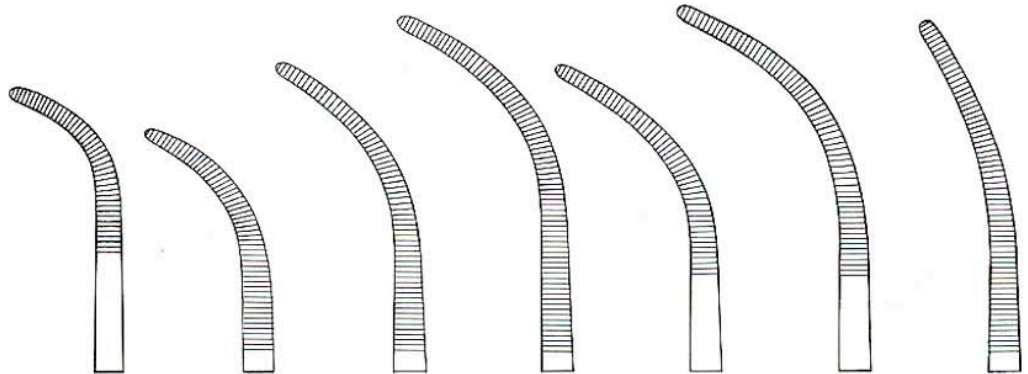

RU 3291-21 RU 3292-21 RU 3293-21 RU 3294-21 RU 3295-21 RU 3296-21 RU 3297-21
 RU 3291-27 RU 3292-27 RU 3293-27 RU 3294-27 RU 3295-27 RU 3296-27 RU 3297-27

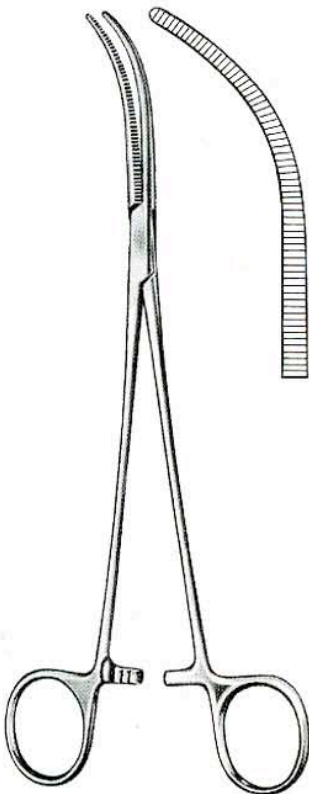

Overholt-Mixter

21 cm/8¹/₄"
RU 3298-21

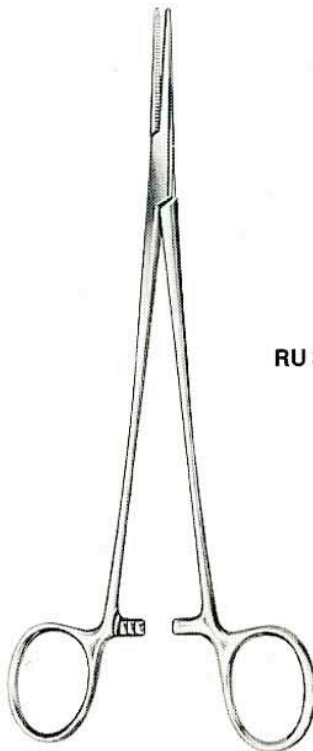

Heiss

20 cm/8"

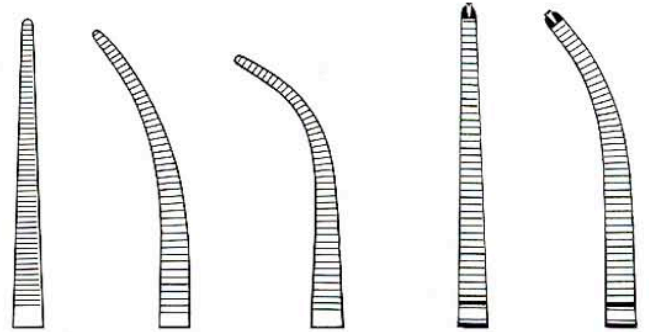

RU 3301-20 RU 3302-20 RU 3303-20 RU 3305-20 RU 3306-20

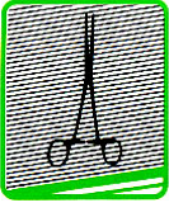

Präparier- und Ligaturklemmen
Dissecting and Ligature Forceps
Pinzas para preparaciones y ligaduras
Pinces à disséquer et à ligatures
Pinze per dissezione e legature



Meeker
 27 cm/10 1/2"
 RU 3308-27

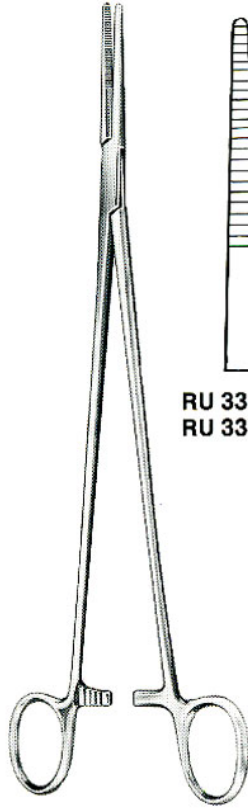

Tönnis
 21 cm/8 1/4"
 26 cm/10 1/4"

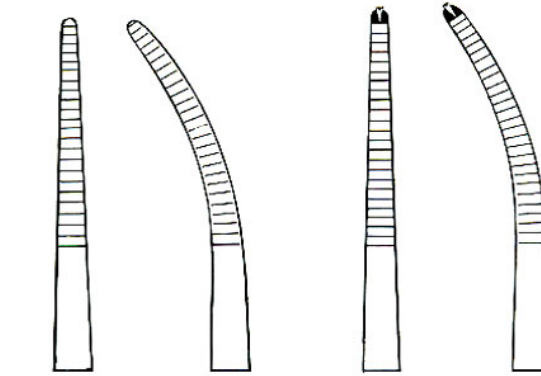

RU 3310-21 RU 3311-21 RU 3320-21 RU 3321-21
 RU 3310-26 RU 3311-26 RU 3320-26 RU 3321-26

Gallenkanalklemmzange
 Gall duct clamp forceps
 Pinzas-clamps para
 conducto biliar
 Pince pour voies biliaire
 Pinza per vie biliari



Lower
 18 cm/7"
 RU 3325-18

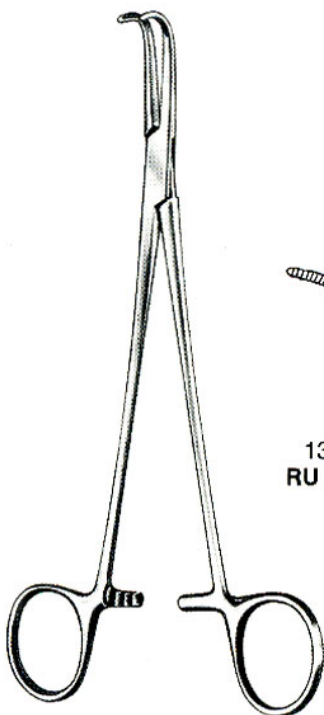

Gemini

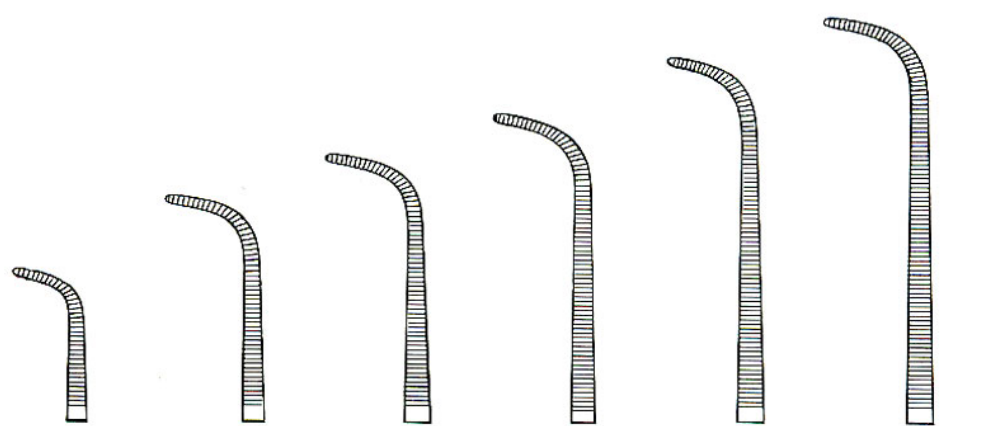

13 cm/5" RU 3326-13
 18 cm/7" RU 3326-18
 20 cm/8" RU 3326-20
 23 cm/9" RU 3326-23
 25 cm/10" RU 3326-25
 27 cm/10 1/2" RU 3326-27



Präparier- und Ligaturklemmen
Dissecting and Ligature Forceps
Pinzas para preparaciones y ligaduras
Pinces à disséquer et à ligatures
Pinze per dissezione e legature

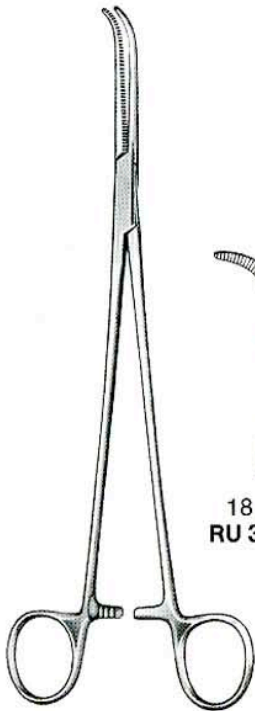
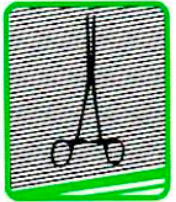

Mini-Gemini

18 cm/7"
RU 3327-18



22 cm/8³/₄"
RU 3327-22



25 cm/10"
RU 3327-25



28 cm/11"
RU 3327-28

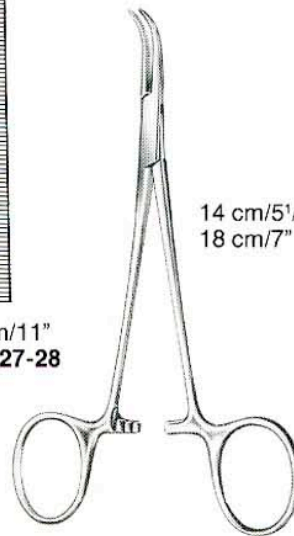

Baby-Mixer

14 cm/5¹/₂"
18 cm/7"



RU 3328-01

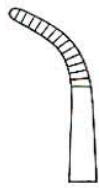

RU 3328-14
RU 3328-18

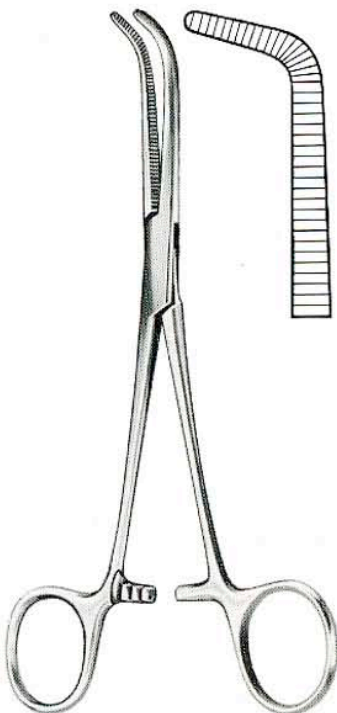

Mixer

RU 3330-15 15 cm/6"
RU 3330-19 19 cm/7¹/₂"



Mixer O'Shaugnessy

RU 3335-15 15,5 cm/6"
RU 3335-19 19 cm/7¹/₂"

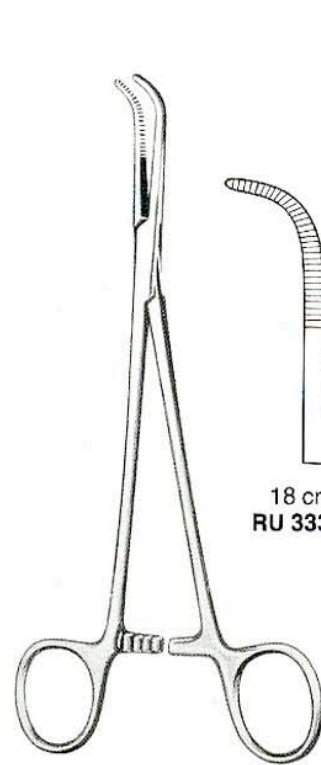

Mixer-Slim

18 cm/7"
RU 3336-18

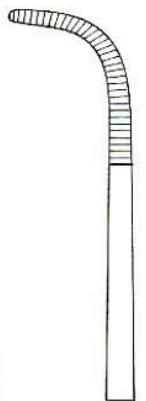

23 cm/9"
RU 3336-23

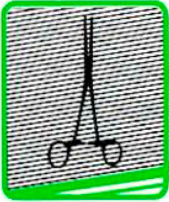

Präparier- und Ligaturklemmen, Gallenkanalklemmen
Dissecting and Ligature Forceps, Gall Duct Clamps
Pinzas para preparaciones y ligaduras, Pinzas para conducto biliar
Pinces à disséquer et à ligatures, Pincés-clamps pour voies biliaires
Pinze per dissezione e legature, Pinze per vie biliari



22 cm/8³/₄"
RU 3341-22

Mixer

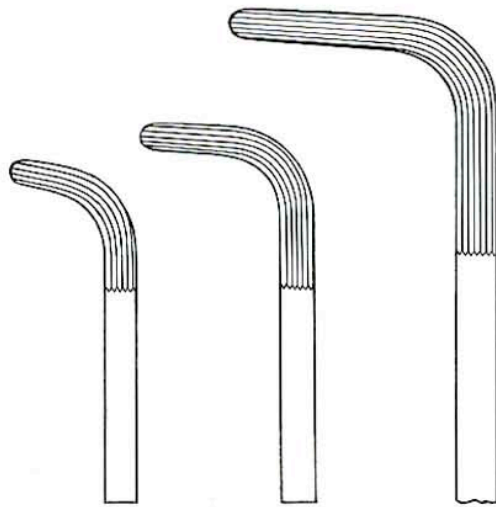

25 cm/10"
RU 3342-25

28 cm/11"
RU 3343-28



Mixer
22 cm/8³/₄"
RU 3350-22



Wickstroem
20 cm/8"
RU 3351-20



Finocchietto
24 cm/9¹/₂"
RU 3352-24

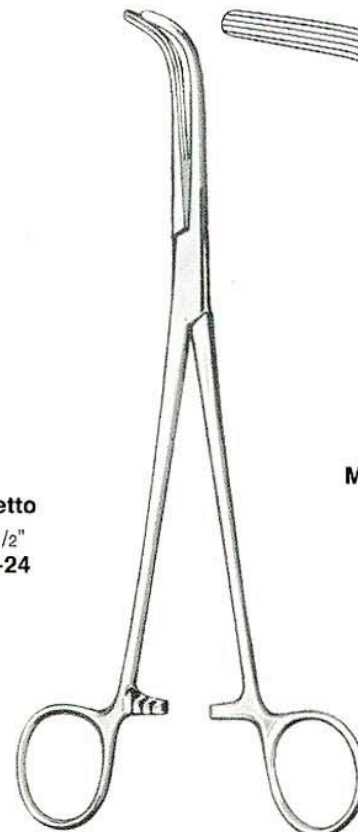

MC Quigg-Mixer
22 cm/8³/₄"
RU 3356-22



Präparierklemmen, Gallenkanalklemmzangen, Arterienklemmen
 Dissecting Forceps, Gall Duct Clamps, Hemostatic Forceps
 Pinzas para preparaciones, Pinzas-clamps para ducto biliar, Pinzas hemostáticas
 Pinces à disséquer, Pinces-clamps pour voies biliaires, Pinces hémostatiques
 Pinze per dissezione, Pinze per vie biliari, Pinze emostatiche

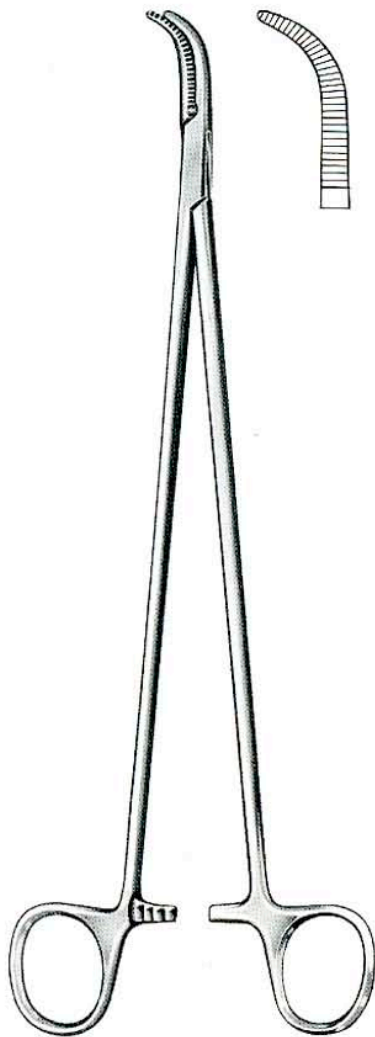
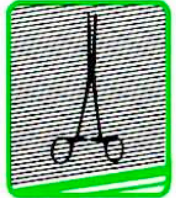

Lawrence
 27,5 cm/10³/₄"
 RU 3355-27

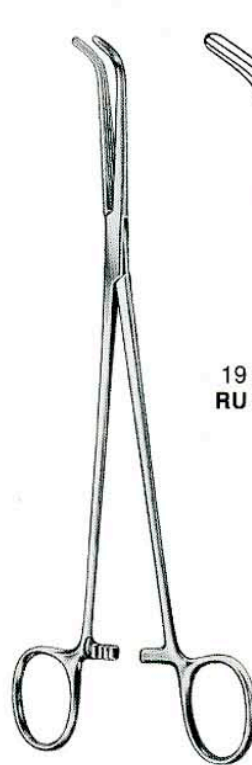

Lahey (Sweet)

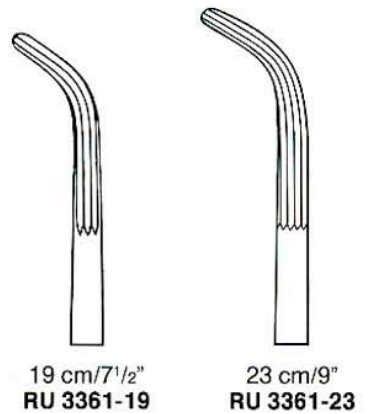

19 cm/7¹/₂"
 RU 3361-19

23 cm/9"
 RU 3361-23



Spencer-Wells

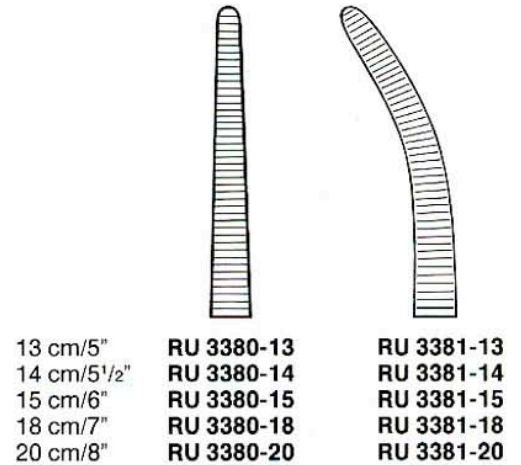

13 cm/5"
 14 cm/5¹/₂"
 15 cm/6"
 18 cm/7"
 20 cm/8"

RU 3380-13
 RU 3380-14
 RU 3380-15
 RU 3380-18
 RU 3380-20

RU 3381-13
 RU 3381-14
 RU 3381-15
 RU 3381-18
 RU 3381-20

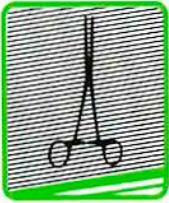

Parametrium- und Hysterektomieklemmen
 Parametrium Forceps, Hysterectomy Forceps
 Pinzas para parametrio, Pinzas-clamps para hysterectomia
 Pinces à paramètre, Pinces à hystérectomie
 Pinze per parametrium, Pinze per isterectomia

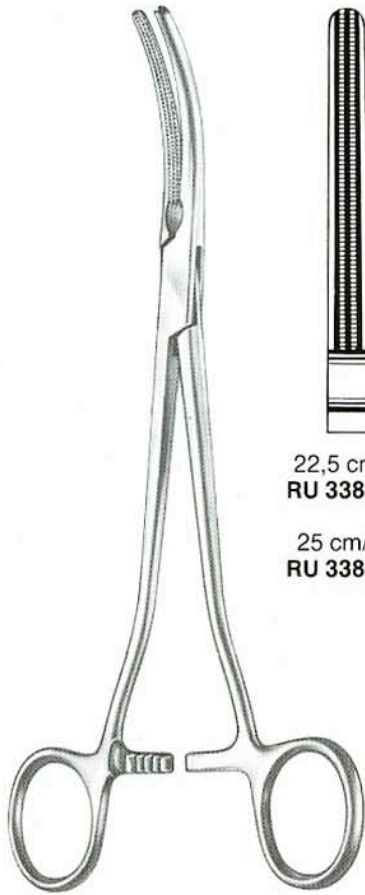

Rogers



22,5 cm/9"
 RU 3383-01

25 cm/10"
 RU 3383-51

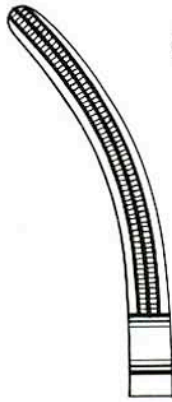

22 cm/8³/₄"
 RU 3383-02

24,5 cm/9³/₄"
 RU 3383-52

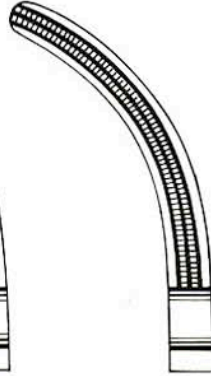

21,5 cm/8¹/₂"
 RU 3383-03

24 cm/9¹/₂"
 RU 3383-53

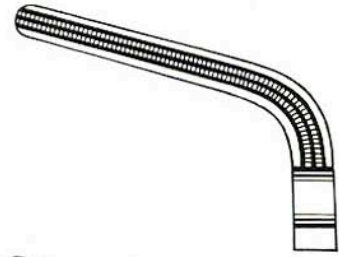

20,5 cm/8"
 RU 3383-04

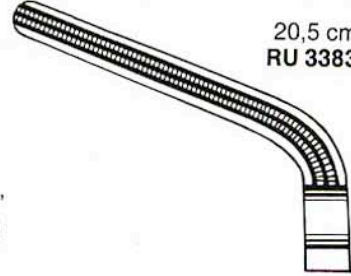

RU 3383-54



Heaney



19,5 cm/7¹/₂"

RU 3384-19



RU 3385-19

21 cm/8¹/₄"

RU 3384-21

RU 3385-21

23 cm/9"

RU 3384-23

RU 3385-23

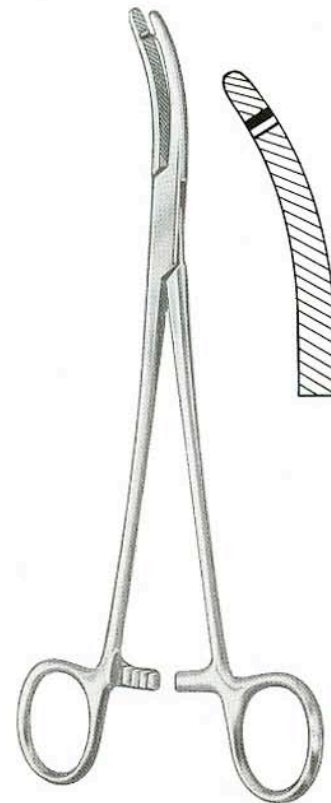

Heaney-Slim

21 cm/8¹/₄"
 RU 3384-21/01



Hysterektomieklemmen
Hysterectomy Forceps
Pinzas-clamps para histerectomia
Pinces à hystérectomie
Pinze per isterectomia

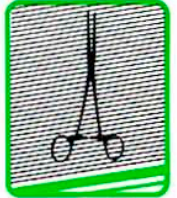

Ballentine
21 cm/8 1/4"
RU 3386-21/01



Heaney-Ballentine
21 cm/8 1/4"
RU 3386-21/02



Tonsillenklemmen
Tonsil forceps
Pinzas para amígdalas
Pinces pour amygdales
Pinze per tonsille

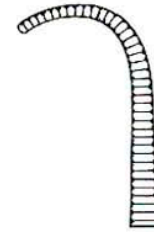
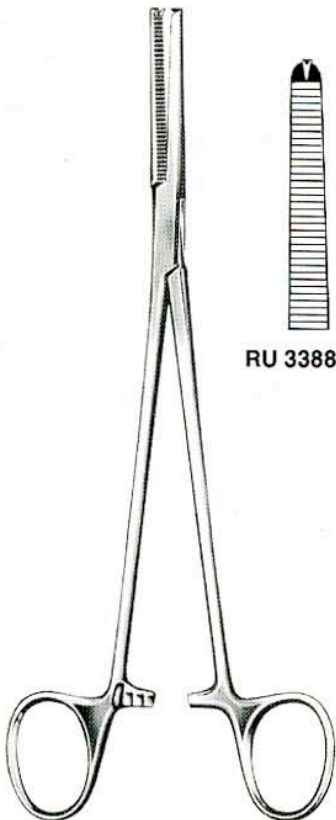

Fig. 1



Fig. 2

Negus
19 cm/7 1/2"
RU 3387-01 RU 3387-02



Phaneuf
21,5 cm/8 1/2"



RU 3388-20

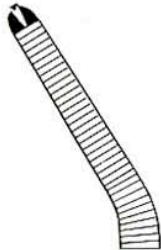

RU 3389-20

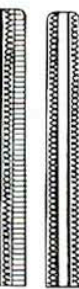
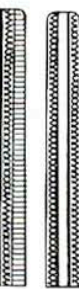
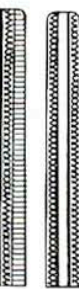
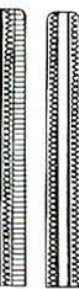
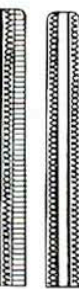
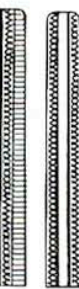
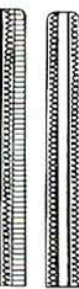
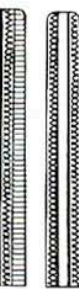
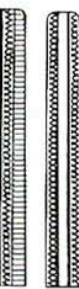
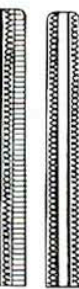
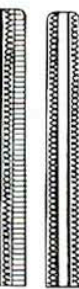
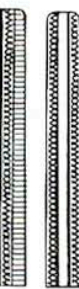
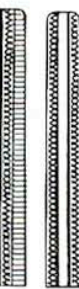
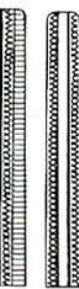
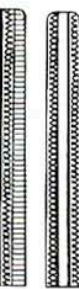
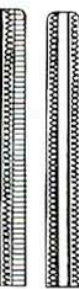
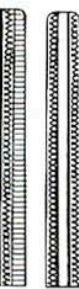
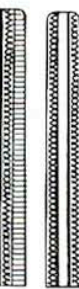
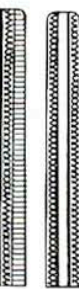
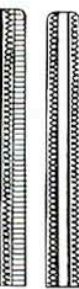
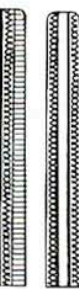
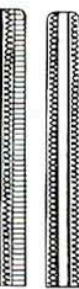
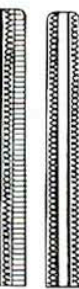
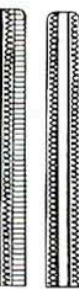
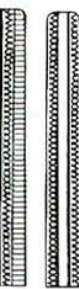
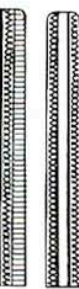
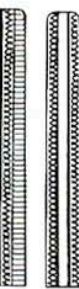
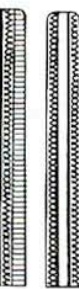
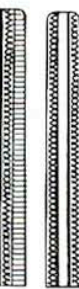
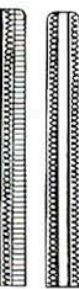
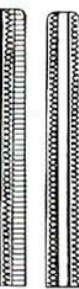
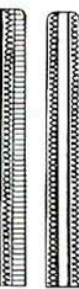
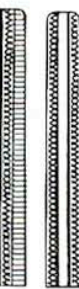
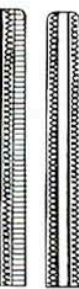
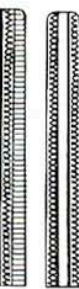
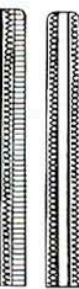
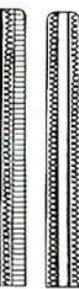
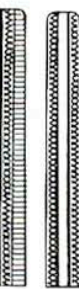
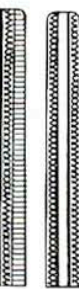
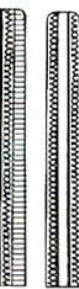
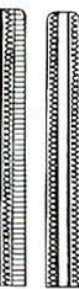
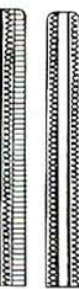
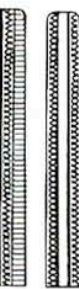
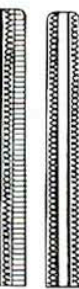
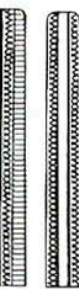
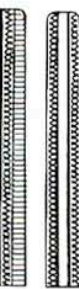
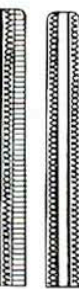
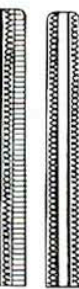
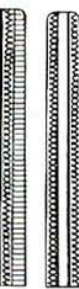
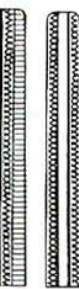
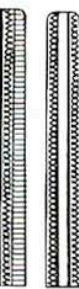
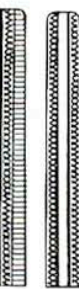
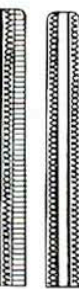
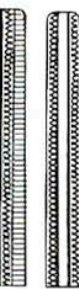
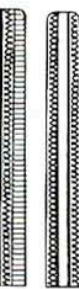
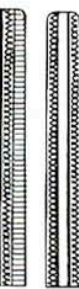
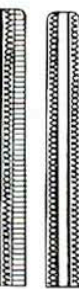
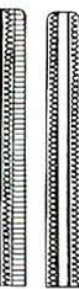
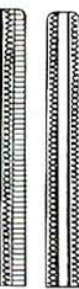
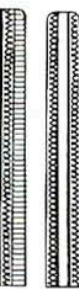
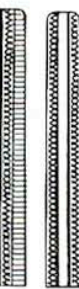
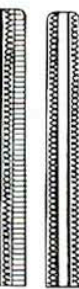
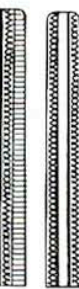
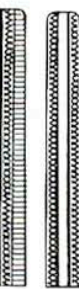
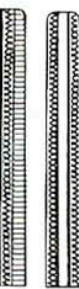
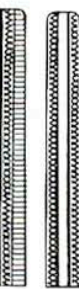
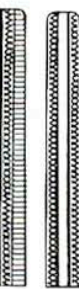
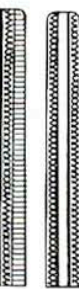
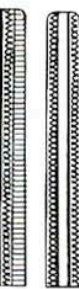
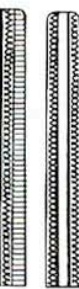
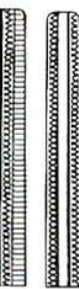
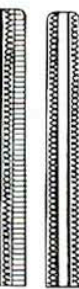
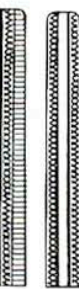
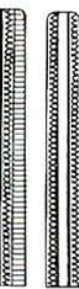
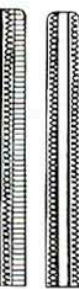
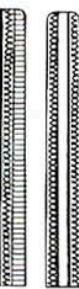
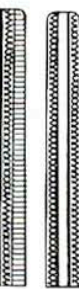
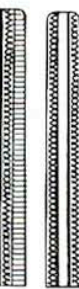
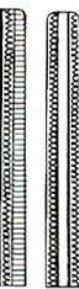
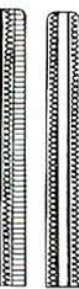
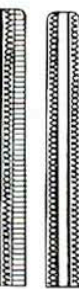
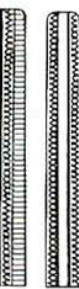
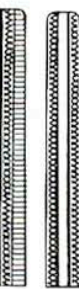
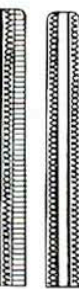
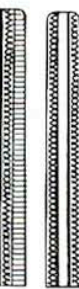
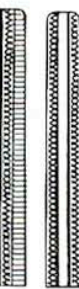
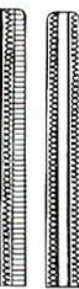
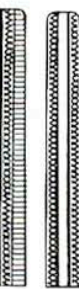
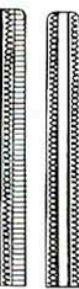
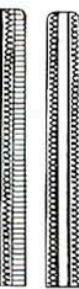
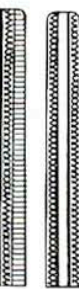
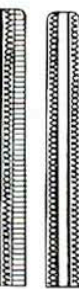
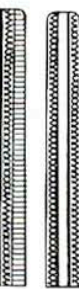
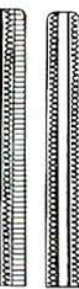
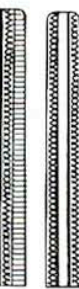
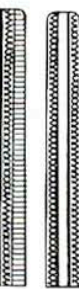
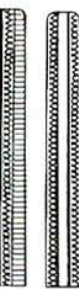
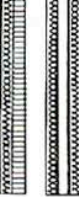
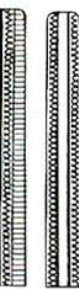

Ferguson

Hämorrhoidalklemmen
Haemorrhoidal clamps
Pinzas hemorroidales
Pinces hémorroïdales
Pinze emorroidali

gerade straight
droites droites
rette rette

gebogen curved
courbes courbes
curve curve

16 cm/6 1/4" RU 3390-16 RU 3391-16

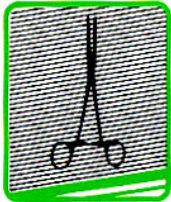

Klemmzangen, Arterienklemmen
Clamp Forceps, Artery Forceps
Pinzas-clamps, Pinzas hemostáticas
Pinces-clamps, Pinces hémostatiques
Pinze emostatiche, Pinze per arterie

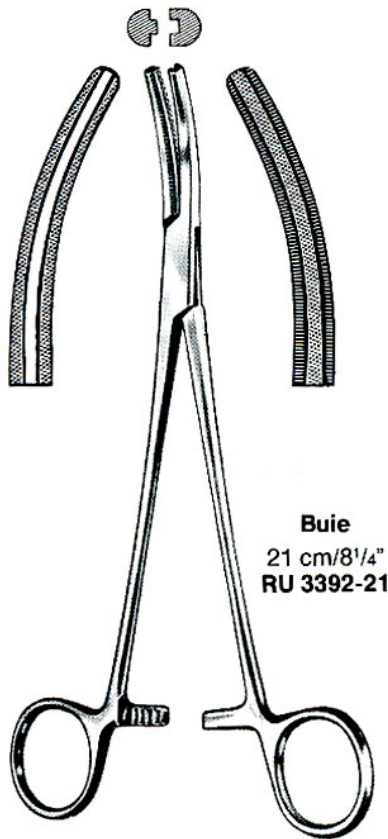

Buie
 21 cm/8 1/4"
 RU 3392-21

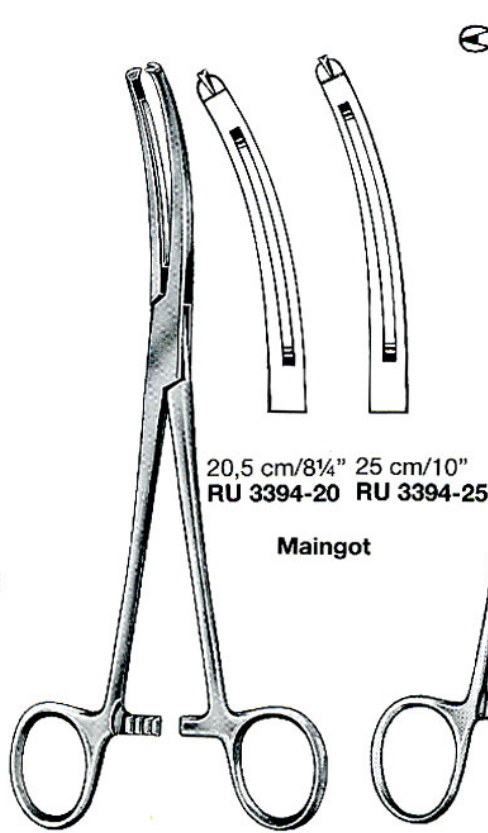

20,5 cm/8 1/4" 25 cm/10"
 RU 3394-20 RU 3394-25

Maingot

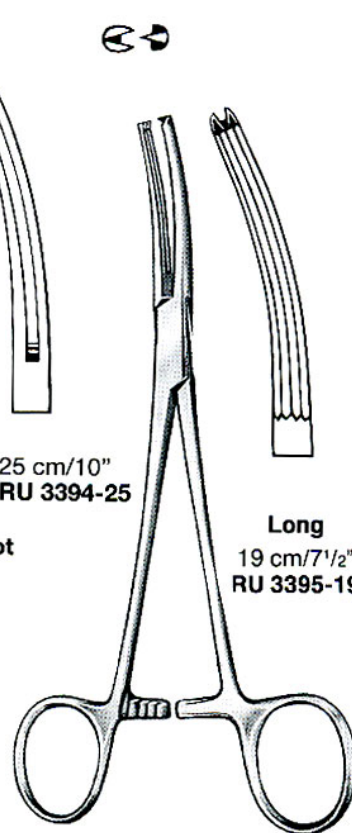

Long
 19 cm/7 1/2"
 RU 3395-19

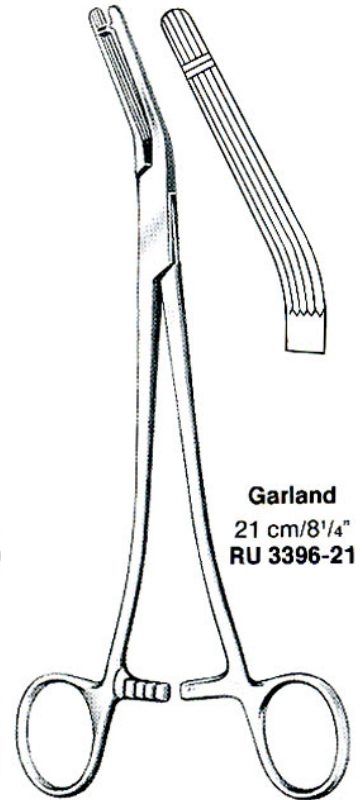

Garland
 21 cm/8 1/4"
 RU 3396-21

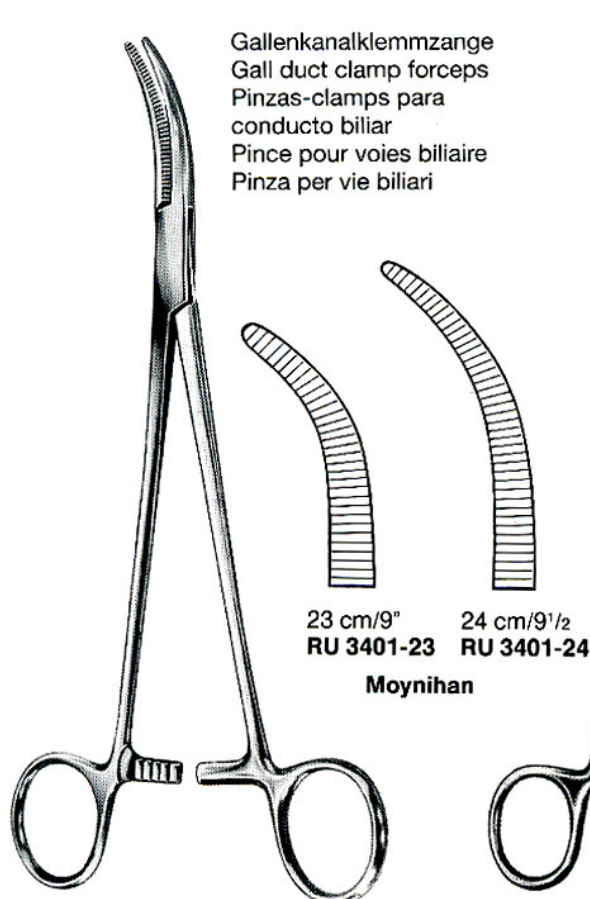

Gallenkanalklemmzange
 Gall duct clamp forceps
 Pinzas-clamps para
 conducto biliar
 Pince pour voies biliaire
 Pinza per vie biliari

23 cm/9" 24 cm/9 1/2"
 RU 3401-23 RU 3401-24

Moynihan

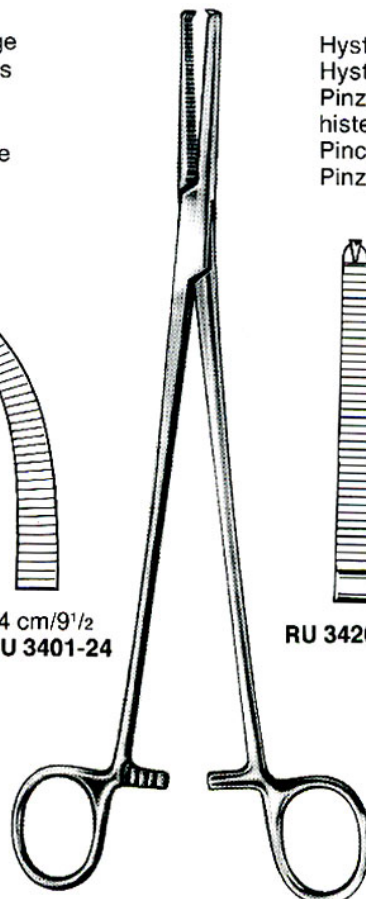

Hysterektomieklemmen
 Hysterectomy forceps
 Pinzas-clamps para
 histerectomia
 Pinces à hystérectomie
 Pinze per isterectomia

RU 3420-23 RU 3421-23

Holzbach
 23,5 cm/9 1/4"

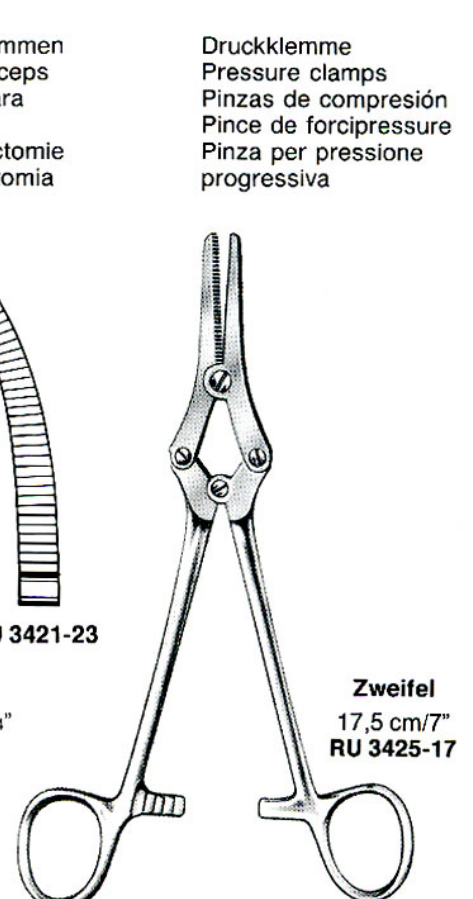

Druckklemme
 Pressure clamps
 Pinzas de compresión
 Pince de forcipressure
 Pinza per pressione
 progressiva

Zweifel
 17,5 cm/7"
 RU 3425-17



Hysterektomieklemmen, Klemmzangen, Vaginalklemmen
Hysterectomy Forceps, Clamp-Forceps, Vaginal Forceps
Pinzas-clamps para histerectomia, Pinzas-clamps, Pinzas vaginales
Pinces à hystérectomie, Pincas-clamps, Pincas vaginales
Pinze per isterectomia, Pinze emostatiche, Pinze vaginali

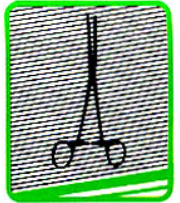

Kopfhautklemme
Scalp flap forceps
Pinzas hemostáticas para pericraneo
Pince hémostatique pour le cuir chevelu
Pinze emostatiche per il cuoio capelluto



De Martel (Willet)
14 cm/5½"
RU 3426-14



De Martel (Willet)
19 cm/7½"
RU 7420-19

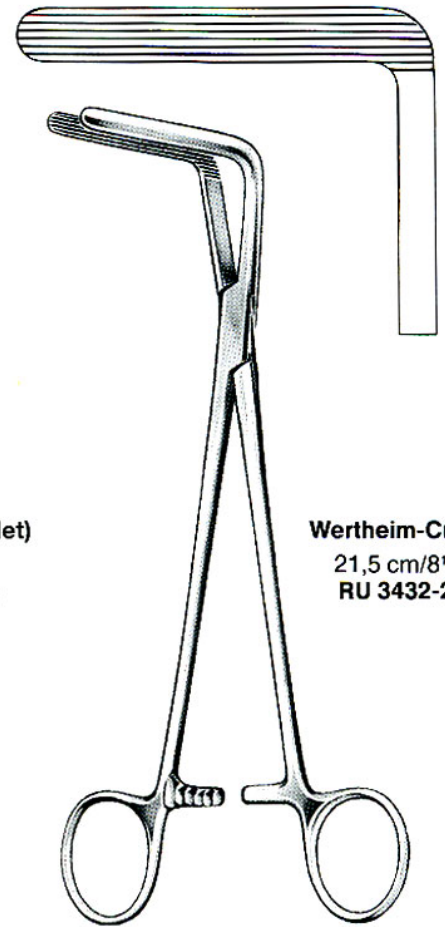

Werheim-Cullen
21,5 cm/8½"
RU 3432-21



Werheim
25 cm/10"
RU 3430-25

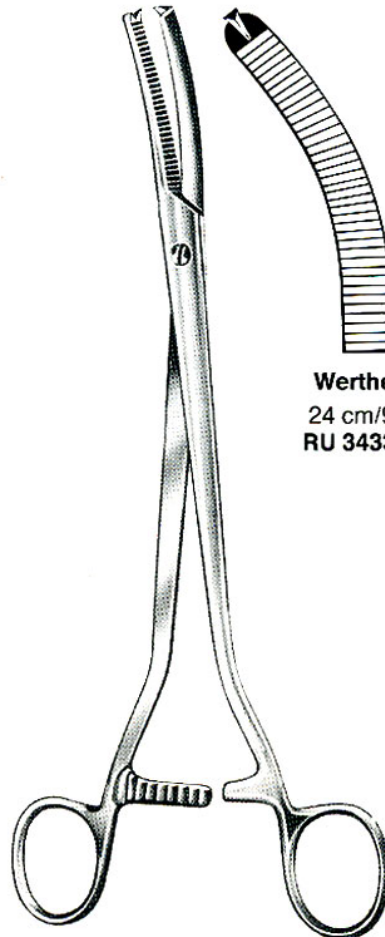

Werheim
24 cm/9½"
RU 3433-24

extra stark
extra strong
muy fuerte
extra forte
molto forti

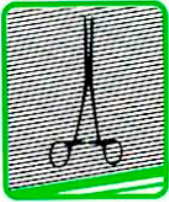

Klemmzangen, Hysterektomieklemmen, Vaginalklemmen
 Clamp Forceps, Hysterectomy and Vaginal Forceps
 Pinzas-clamps, Pinzas-clamps para hysterectomia, Pinzas vaginales
 Pincers-clamps, Pincers à hystérectomie, Pincers vaginales
 Pinze emostatiche, Pinze per isterectomia, Pinze vaginali

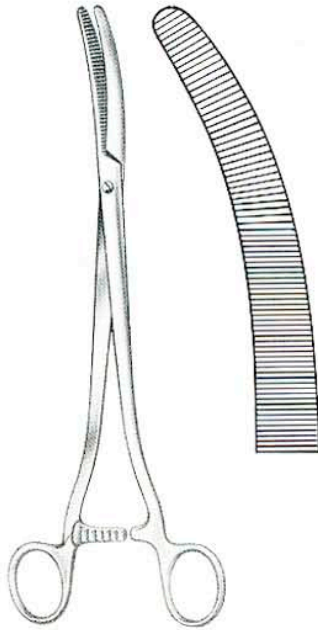

Faure
 25 cm/10"
 RU 3433-50/01



23 cm/9"

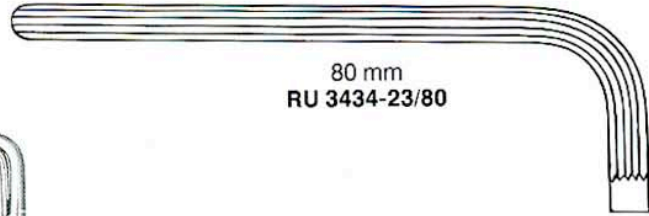

80 mm
 RU 3434-23/80

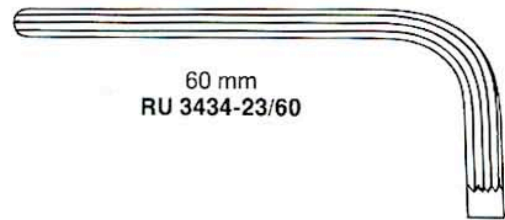

60 mm
 RU 3434-23/60



Wertheim
 22 cm/8³/₄"



leicht gebogen
 slightly curved
 curva ligera
 courbure légère
 curva leggera
 RU 3435-22



mehr gebogen
 more curved
 curva fuerte
 courbure forte
 curva forte
 RU 3436-22



Peritoneumklemmen
Peritoneal Clamp Forceps
Pinzas para peritoneo
Pinces-clamps pour le péritoine
Pinze per peritoneo

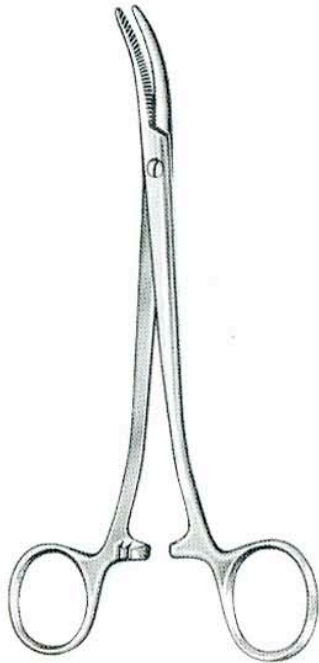
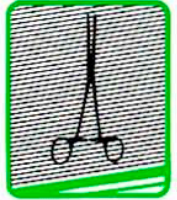

Werheim
18 cm/7"
RU 3438-18

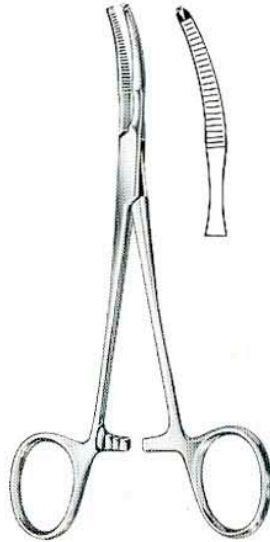

Baby-Mikulicz
14 cm/5 1/2"
RU 3492-14

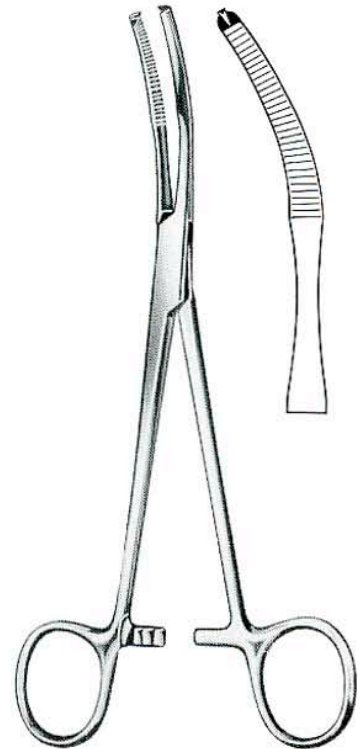

Mikulicz
RU 3500-18 18 cm/7"
RU 3500-20 20 cm/8"

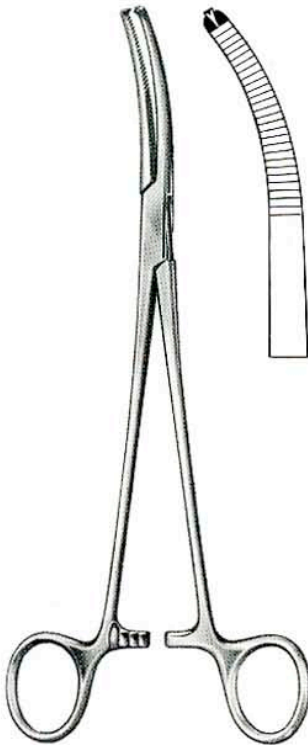

Mikulicz
20 cm/8"
RU 3501-20

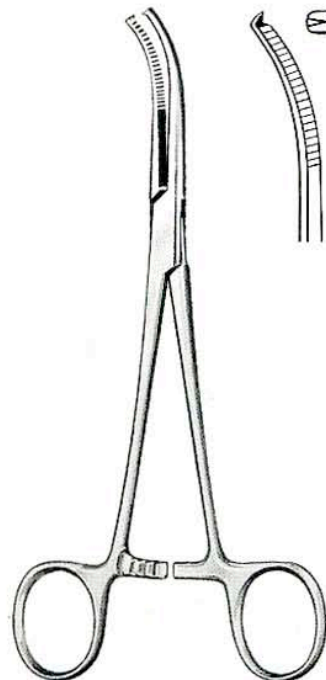

Mikulicz
18,5 cm/7 1/4"
RU 3502-18

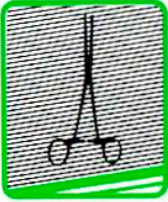

Peritoneumklemmen, Hysterektomieklemmen
Peritoneal Clamp Forceps, Hysterectomy Forceps
Pinzas para peritoneo e histerectomia
Pinces-clamps pour le péritoine, Pincès à hystérectomie
Pinze per peritoneo ed isterectomia

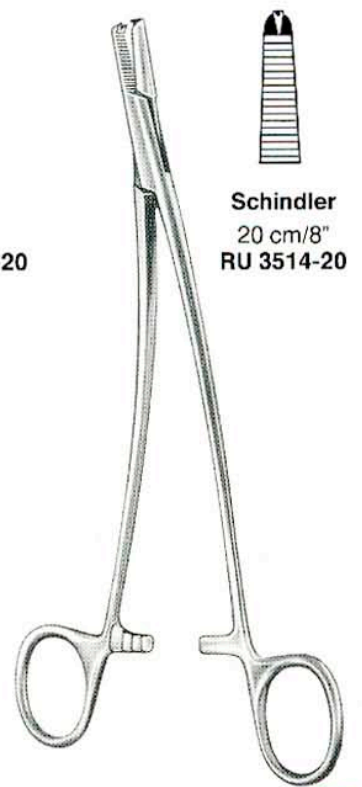
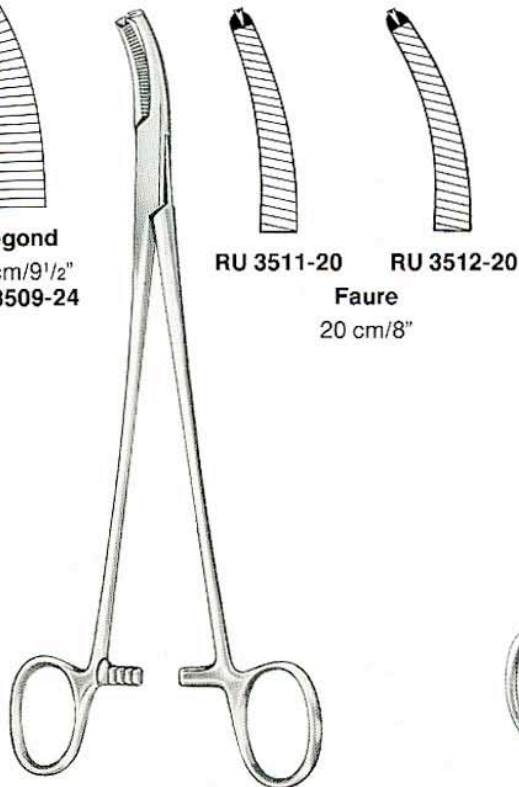
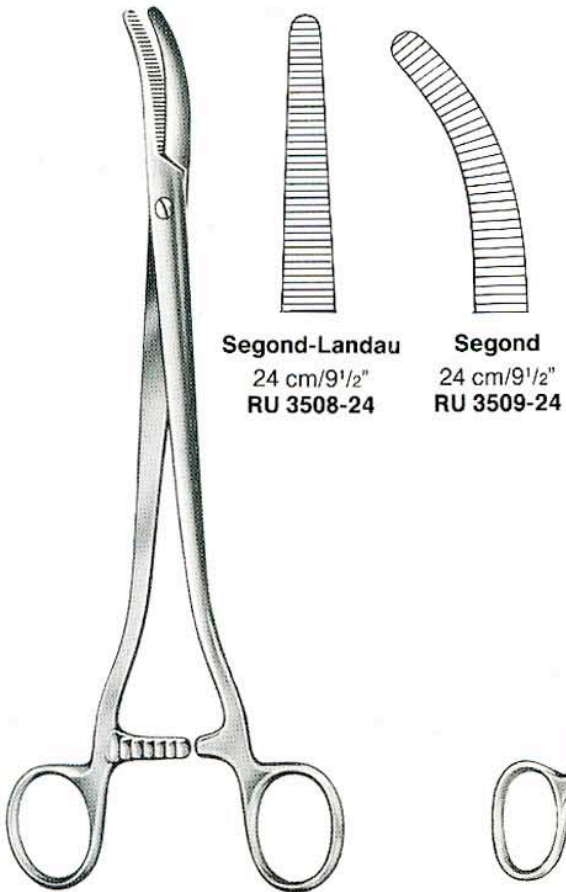
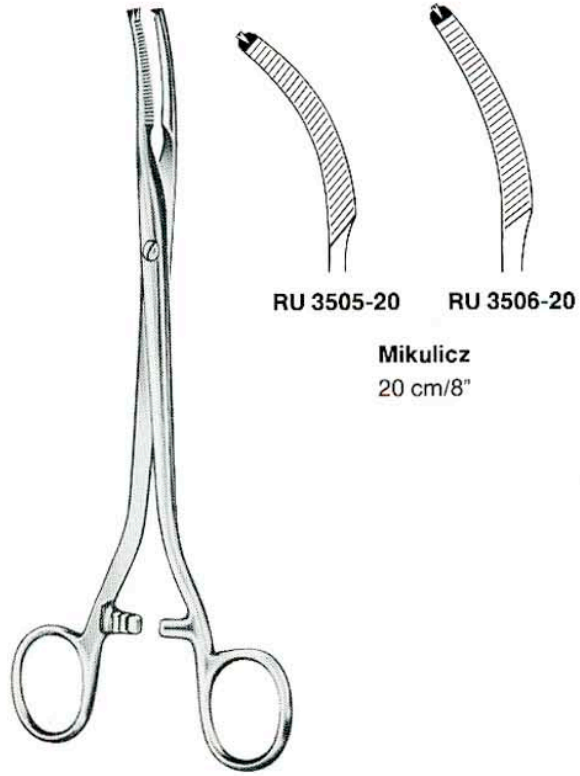
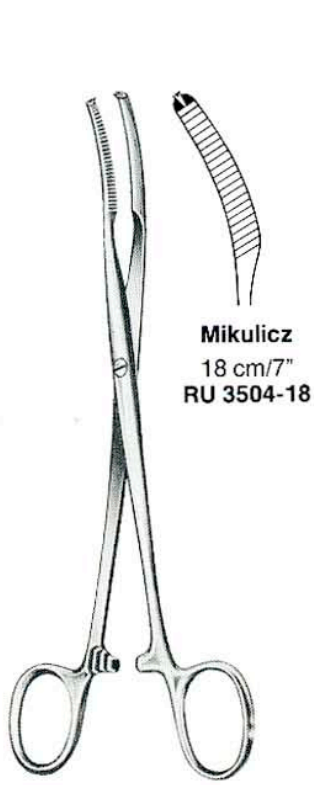



Tuchklemmen
Towel Forceps
Pinzas de campo, Pinzas para compresas
Pinces à champs
Pinze fissateli

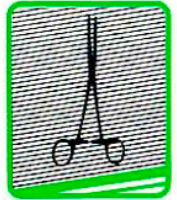

Schädel
 9 cm/3 1/2"
 RU 3550-09



Jones
 RU 3552-05 5 cm/2"
 RU 3552-09 9 cm/3 1/2"



Engl. Modell
 9 cm/3 1/2"
 RU 3553-09

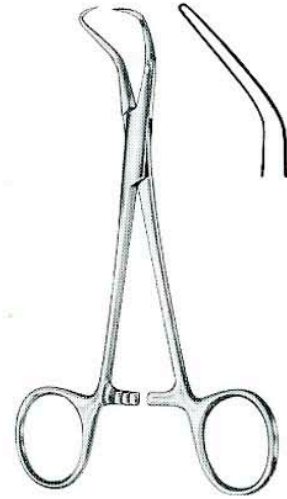

Backhaus
 RU 3600-09 9 cm/3 1/2"
 RU 3600-11 11 cm/4 1/2"
 RU 3600-13 13 cm/5"
 RU 3600-15 15 cm/6"

mit Schlauch- oder Kabelhalter
 with clip for tubing or cable
 con soporte para tubo ó cable
 avec clamp porte-tube ou
 porte-cordon d'alimentation
 con porta-tubo o porta-cavo

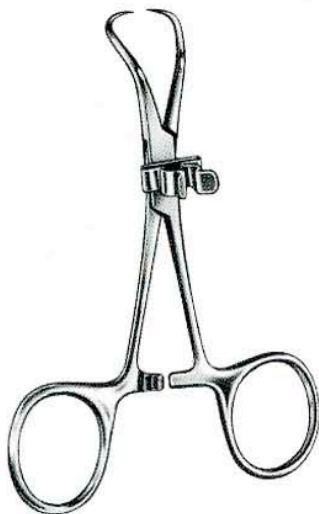

RU 3602-11 11 cm/4 1/2"
 RU 3602-13 13 cm/5"

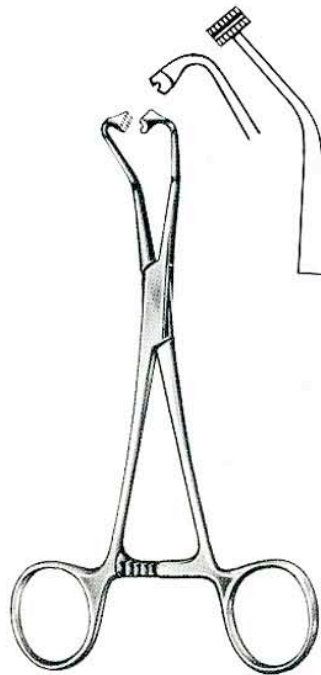

Peers-Bertram
 14,5 cm/5 3/4"
 RU 3604-14

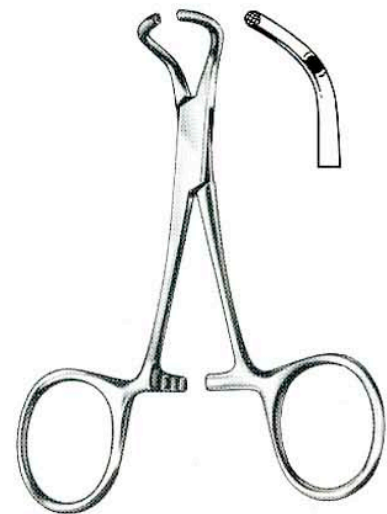

Tohoku
 RU 3605-10 10 cm/4"
 RU 3605-13 13 cm/5"

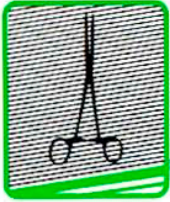

Tuchklemmen
Towel Forceps
Pinzas de campo, Pinzas para compresas
Pinces à champs
Pinze fissateli

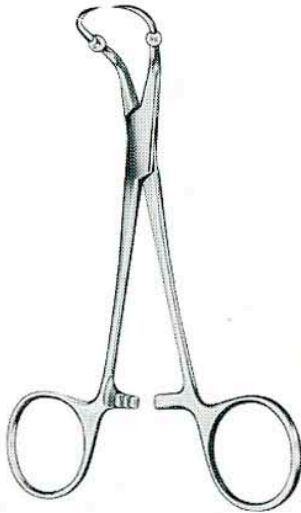

Röder

RU 3610-13 13 cm/5"
RU 3610-15 15 cm/6"



für Papiertücher
for paper cloths
para tela de papel
pour serviettes en papier
per telo di carta

RU 3617-11 11 cm/4½"
RU 3617-13 13 cm/5"

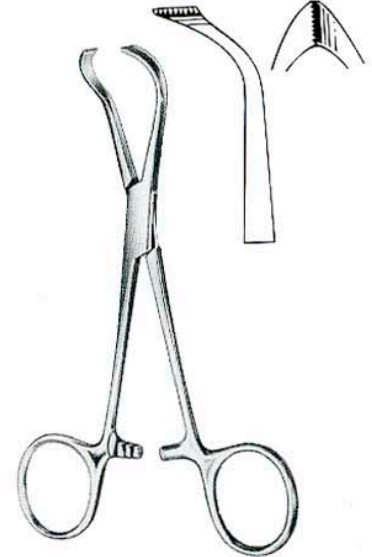

Lorna

RU 3618-10 10 cm/4"
RU 3618-13 13 cm/5"

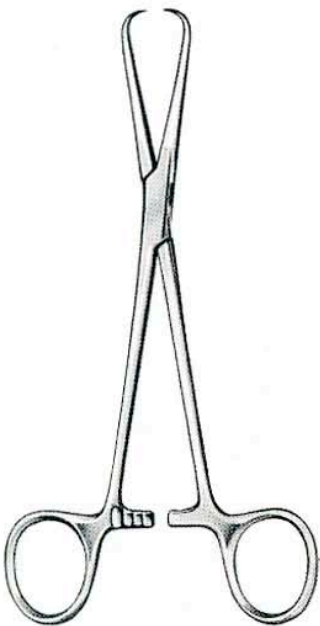

Bernhard

16,5 cm/6½"
RU 3620-16



Lane

RU 3622-13 13 cm/5"
RU 3622-15 15,5 cm/6"
RU 3622-20 20 cm/8"



Doyen

18 cm/7"
RU 3625-18



Schlauchklemmen
 Tubing Forceps
 Pinzas para tubos
 Clamps à tube
 Pinze serratubi

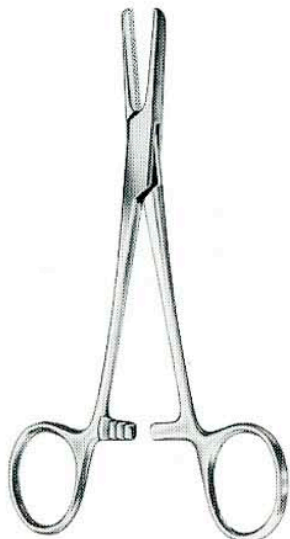
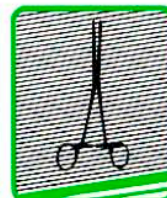

RU 3680-15 15 cm/6"
 RU 3680-18 18 cm/7"
 RU 3680-20 20 cm/8"

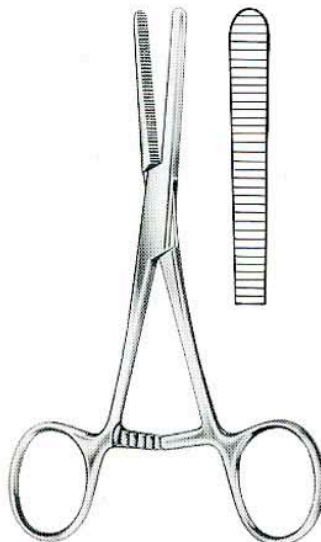

14,5cm/5³/₄"
 RU 3682-14

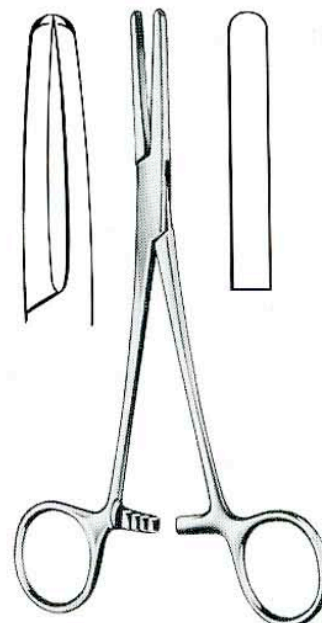

RU 3684-16 16,5 cm/6¹/₂"
 RU 3684-18 18 cm/7"

mit Schutzbügel
 with safety guard
 con estribo de protección
 avec barre de protection
 con protezione

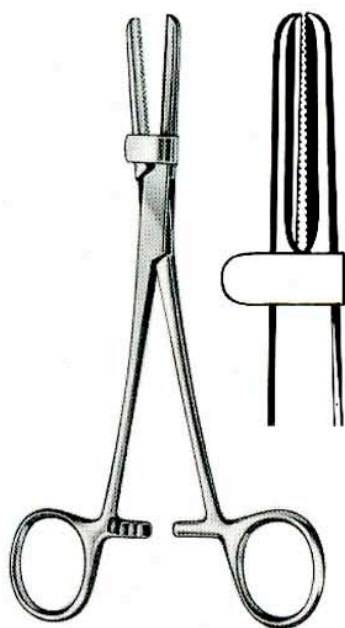

RU 3686-15 15 cm/6"
 RU 3686-18 18 cm/7"
 RU 3686-20 20 cm/8"



Mohr

RU 3690-50 50 mm
 RU 3690-60 60 mm
 RU 3690-70 70 mm
 RU 3690-80 80 mm

Größe
 sizes
 tamaño
 dimension
 grandezza
 mm
 13
 17
 20
 25
 30
 40

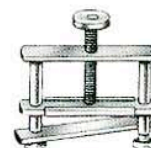

Hoffmann

RU 3692-13
 RU 3692-17
 RU 3692-20
 RU 3692-25
 RU 3692-30
 RU 3692-40

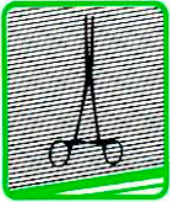

Korn-(Polypen) Tupferzangen
Cotton Swab Forceps, Polypus and Dressing Forceps
Pinzas para tampones, Pinzas para polipos y vendajes
Pinces à tampons, Pinces à pansements et à polypes
Pinze per medicazioni uterine, Pinze per polipi

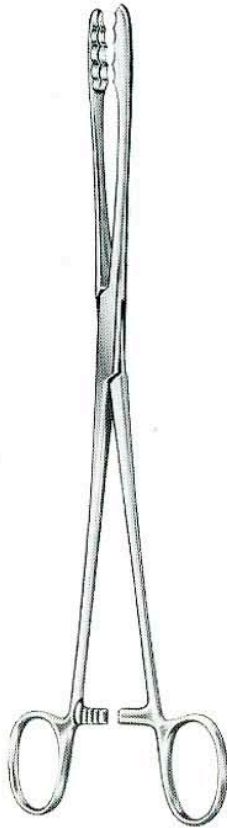

Ulrich

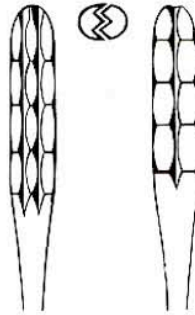

gerade
 straight
 rectas
 droites
 rette

RU 3800-22
RU 3800-25
RU 3800-27

22 cm/8³/₄"
 25 cm/10"
 27 cm/10¹/₂"

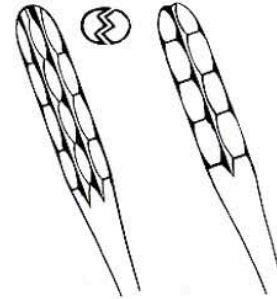

gebogen
 curved
 curvas
 courbes
 curve

RU 3801-22
RU 3801-25
RU 3801-27

Sinusklemmen
 Sinus forceps
 Pinzas para seno
 Pinces à sinus
 Pinze sinus

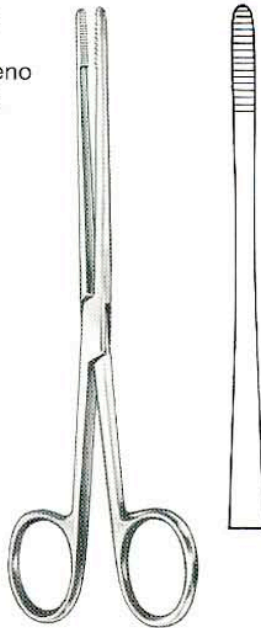

Lister

RU 3810-12 12,5 cm/5"
RU 3810-16 16 cm/6¹/₄"
RU 3810-18 18 cm/7"

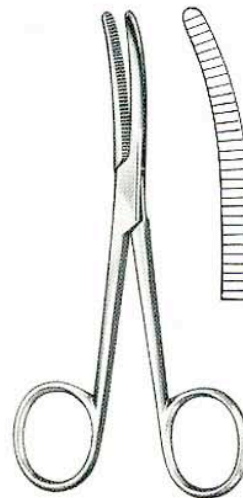

Bryant

13 cm/5"
RU 3812-13



Korn-(Polypen) Zangen
Polypus and Dressing Forceps
Pinzas para polipos y vendajes
Pinces à pansement et à polypes
Pinze per polipi

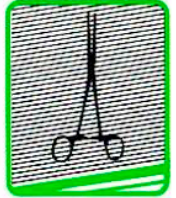

Gross-Maier

mit Sperre
 with ratchet
 con cremallera
 avec crémaillère
 con cremagliera

gerade
 straight
 rectas
 droites
 rette

RU 3860-20
RU 3860-25

20 cm/8"
 25 cm/10"

gebogen
 curved
 curvas
 courbes
 curve

RU 3861-20
RU 3861-25

ohne Sperre
 without ratchet
 sin cremallera
 sans crémaillère
 senza cremagliera

RU 3862-20
RU 3862-25

20 cm/8"
 25 cm/10"

RU 3863-20
RU 3863-25



Pelkmann
 25 cm/10"



RU 3872-25



RU 3873-25

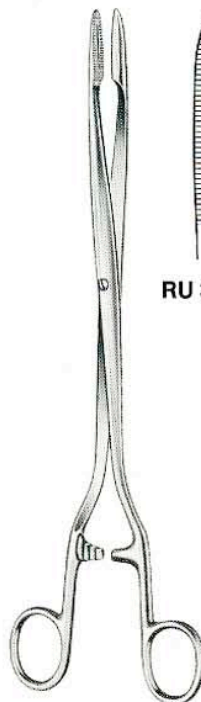

Sims-Maier
 28 cm/11"



RU 3874-28

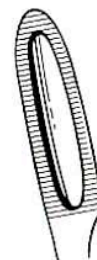

RU 3875-28



Duplay
 20 cm/8"



RU 3880-20



RU 3881-20

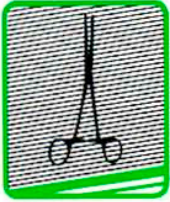

Tupferzangen
Cotton Swab Forceps
Pinzas para tampones
Pinces à tampons
Pinze per tamponi

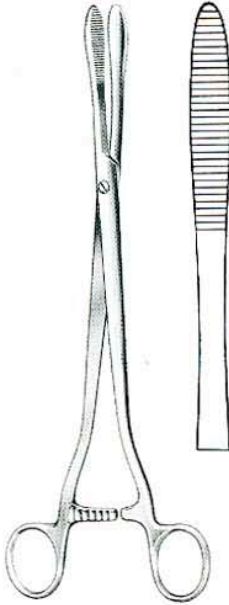

Collin
 25 cm/10"
 RU 3887-25

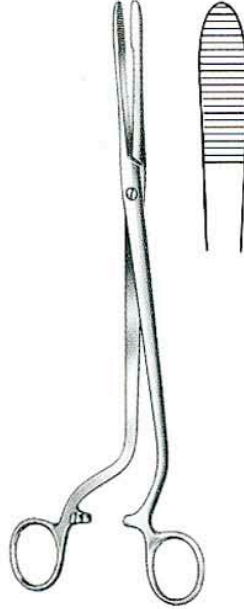

Cheron
 25 cm/10"
 RU 3888-25



Emmet
 21 cm/8 1/4"
 RU 3889-21

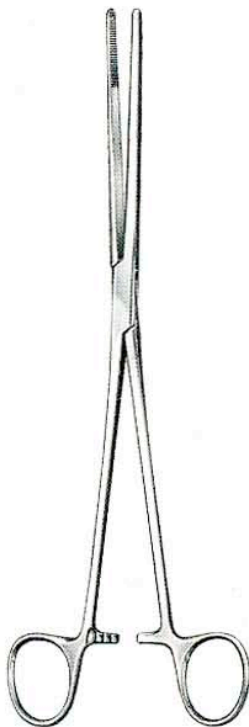

Bozemann
 26 cm/10 1/4"
 RU 3890-26

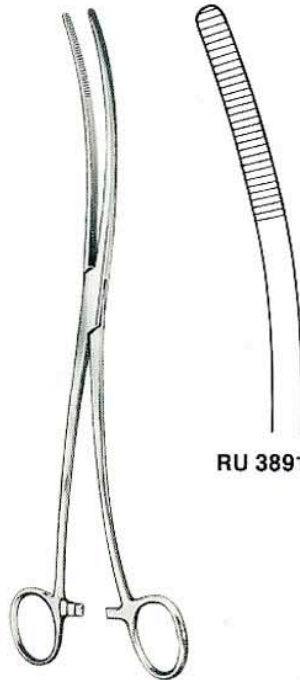

Bozemann
 26 cm/10 1/4"



RU 3891-26



glatt
 smooth
 lissas
 lisses
 liscie

RU 3892-26



Tupferzangen, Schwammzangen
Cotton Swab Forceps, Sponge Holding Forceps
Pinzas para tampones, Pinzas porta-esponjas
Pinces à tampons, Pinces à éponges
Pinze per tamponi e spugne

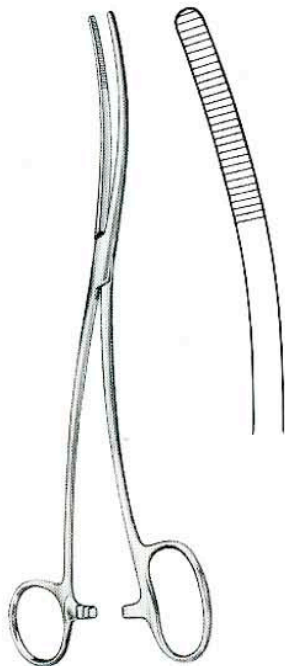
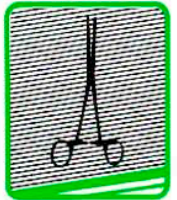

Bozemann-Douglas
 26 cm/10¹/₄"
 RU 3893-26

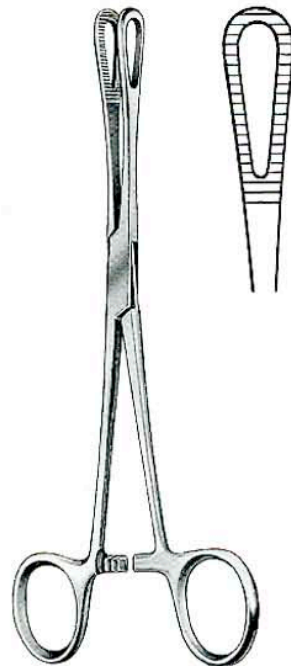

Rampley
 RU 3896-18 18 cm/7"
 RU 3896-25 25 cm/10"

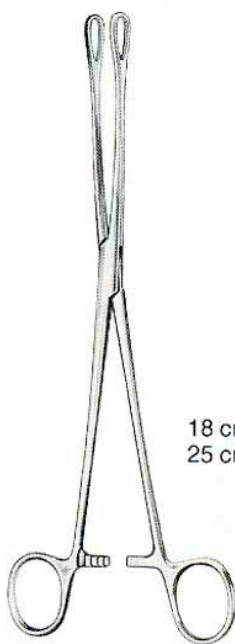

Förster
(Förster-Ballenger)

18 cm/ 7"
 25 cm/10"

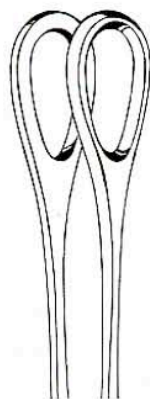

RU 3900-18
 RU 3900-25

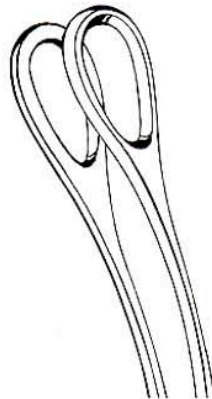

RU 3901-18
 RU 3901-25

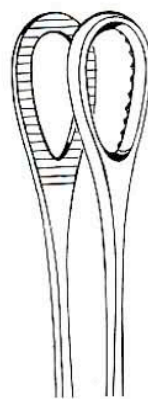

RU 3910-18
 RU 3910-25

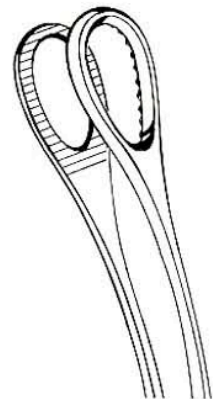

RU 3911-18
 RU 3911-25

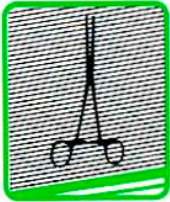

Bulldogklemmen
Bulldog Clamps
Clamps Bulldog
Clamps Bulldog
Pinze Bulldog

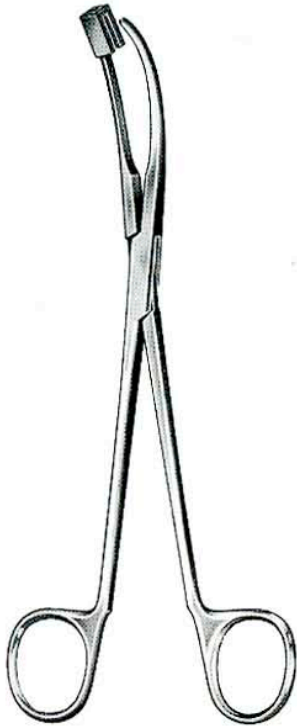

Schwartz
 19 cm/7 1/2"
 RU 3930-80



RU 3930-01



RU 3930-02



RU 3930-03

Anlegezange
 Applying forceps
 Pinzas para poner clips
 Pince à application
 Pinza per Bulldog

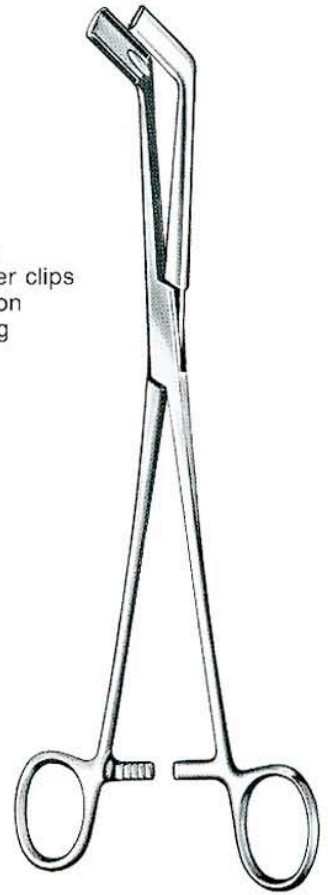

23 cm/9"
 RU 7586-00

Atrauma



Diethrich

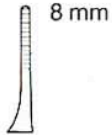

RU 3934-08

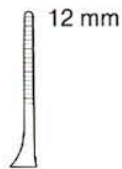

RU 3934-12



RU 3934-16



RU 3934-60



RU 3934-64



RU 3934-70

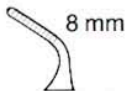

RU 3935-08



RU 3935-12

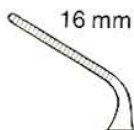

RU 3935-16



RU 3935-60



RU 3935-64



RU 3935-70



Gefäßclips
Vessel Clips
Clips vasculares
Serre-fines
Serrafini

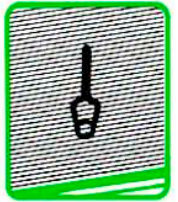

14 cm/5 1/2"
RU 3940-14

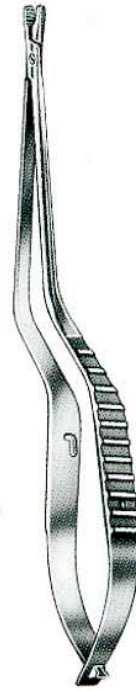

RU 3941-18 18 cm/7"
RU 3941-22 22 cm/8 3/4"

Clip-Anlegezangen
Clip applying forceps
Pinzas para poner micro-clips
Pinces pour poser les serre-fines
Pinze per posizionare micro-clips

Maullänge length of jaw largo de boca longueur de mors lungh. del morso	Maulbreite width of jaw ancho de boca largeur de mors largh. del morso	Schließdruck occlusion pressure presión de oclusión pression d'occlusion pressione occlusiva	gerade straight rectos droites rette	leicht gebogen slightly curved curvos ligeros courbure légère curva leggera	stark gebogen strong curved curvos fuertes courbure forte curva forte	abgewinkelt angled acodados coudé angolate
4 mm	0,75 mm	125 g	RU 3950-04			
6 mm	1,00 mm	100 g	RU 3950-06			
8 mm	2,00 mm	85 g	RU 3950-08			
10 mm	2,00 mm	60 g	RU 3950-10			
4 mm	0,75 mm	150 g	RU 3955-04			
6 mm	1,00 mm	150 g	RU 3955-06	RU 3956-06	RU 3957-06	RU 3958-06
8 mm	2,00 mm	150 g	RU 3955-08			
10 mm	2,00 mm	150 g	RU 3955-10			
4 mm	0,75 mm	70 g	RU 3960-04			
6 mm	0,80 mm	70 g	RU 3960-06			
6 mm	1,00 mm	70 g	RU 3960-07	RU 3966-06	RU 3967-06	RU 3968-06
8 mm	1,00 mm	70 g	RU 3960-08			
10 mm	1,50 mm	70 g	RU 3960-10			

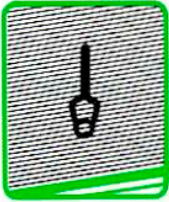

Yasargil Anlegezangen
Yasargil Applying Forceps
Pinzas para poner micro-clips
Pinces pour poser les serre-fines
Pinze per posizionare micro-clips

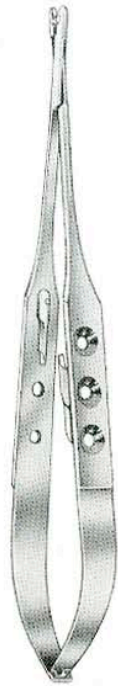

18 cm/7"
RU 3946-01

für Miniclips
for mini clips
para mini-clips vasculares
pour serre-fines mini
per micro-clips



17 cm/6³/₄"
RU 3946-02

21 cm/8¹/₄"
RU 3946-03

23 cm/9"
RU 3946-04

für Standardclips
for standard clips
para clips vasculares estandar
pour serre-fines standards
per clips standard

RU 3946-11

RU 3946-12

RU 3946-13

RU 3946-14













































**Yasargil Gefäßclips
Yasargil Vessel Clips
Yasargil Clips vasculares
Serre-fines Yasargil
Serrafini Yasargil**



Schließdruck
occlusion pressure

presión de oclusión
pression d'occlusion
pressione occlusiva

Mini 70 – 130 g
Standard 90 – 200 g

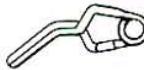
MINI		permanent permanente	STANDARD		permanent permanente
Maullänge length of jaw largo de boca longueur de mors lung. del morso mm	Maulöffnung opening apertura ouverture de mors apertura del morso mm		Maullänge length of jaw largo de boca longueur de mors lung. del morso mm	Maulöffnung opening apertura ouverture de mors apertura del morso mm	
3	3,3	 RU 3947-001	7	6,2	 RU 3948-001
5	4,0	 RU 3947-002	9	7,0	 RU 3948-002
3	3,3	 RU 3947-003	11	7,8	 RU 3948-003
5	4,0	 RU 3947-004	7	6,0	 RU 3948-004
7	4,6	 RU 3947-005	9	6,8	 RU 3948-005
3	3,2	 RU 3947-006	11	7,5	 RU 3948-006
5	3,8	 RU 3947-007	7	5,5	 RU 3948-007
4	3,8	 RU 3947-008	9	6,1	 RU 3948-008
7	4,4	 RU 3947-009	11	6,5	 RU 3948-009
4	3,6	 RU 3947-010	15	9,2	 RU 3948-010
4	3,5	 RU 3947-011	20	11,4	 RU 3948-011
5	4,0	 RU 3947-012	25	13,3	 RU 3948-012
5	3,5	 RU 3947-013	15	8,7	 RU 3948-013
7	5,7	 RU 3947-014	15	7,4	 RU 3948-014
7	4,5	 RU 3947-015	7	7,9	 RU 3948-015
	MINI	temporär temporary temporario temporaire temporaneo	9	8,7	 RU 3948-016
			20	13,0	 RU 3948-017
3	3,3	 RU 3947-101	9	7,8	 RU 3948-018
5	4,0	 RU 3947-102	7	5,6	 RU 3948-019
7	4,6	 RU 3947-105	5	7,2	 RU 3948-020
4	3,8	 RU 3947-107			
7	4,4	 RU 3947-109			
4	3,5	 RU 3947-112	7	5,7	 RU 3948-021

Gefäßclips für temporären Gebrauch sind durch gelb eingefärbte Federenden gekennzeichnet.

Vessel clips for temporary occlusion are identified by yellow coloured spring ends.

Clips vasculares, para oclusión temporaria, identificables mediante, resorte coloreado en amarillo.

Les serre-fines d'usage temporaire sont marqués par des bouts de ressort colorés en jaune.

Serrafini per uso temporaneo sono identificati con colore giallo sulla molla.

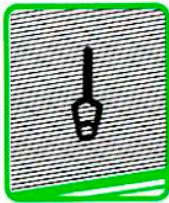















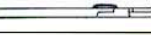

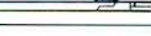













Yasargil Gefäßclips
Yasargil Vessel Clips
Yasargil Clips vasculares
Serre-fines Yasargil
Serrafini Yasargil

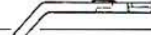

Schließdruck
occlusion pressure

presión de oclusión
pression d'occlusion
pressione occlusiva

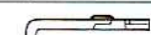
Mini 70 – 130 g
Standard 90 – 200 g

Maullänge length of jaw largo de boca longueur de mors lung. del morso mm	STANDARD		temporär/temporary temporario/temporaire temporaneo	Maullänge length of jaw largo de boca longueur de mors lung. del morso mm	STANDARD		permanent permanente
	Maulöffnung apertura ouverture de mors apertura del morso mm				Maulöffnung apertura ouverture de mors apertura del morso mm		gefenstert fenestrated fenestrado fenêtré fenestrato 
9	7,0		RU 3948-102	7	7,4		RU 3949-001
9	6,8		RU 3948-105	9	8,4		RU 3949-002
9	6,1		RU 3948-108	12	9,6		RU 3949-003
15	9,2		RU 3948-110	5	5,8		RU 3949-004
20	11,4		RU 3948-111	7	6,5		RU 3949-005
15	8,7		RU 3948-113	11	7,2		RU 3949-006
15	7,4		RU 3948-114	5	4,9		RU 3949-007
20	11,0		RU 3948-130	7	4,9		RU 3949-008
17	9,9		RU 3948-131	11	4,9		RU 3949-009
13	7,5		RU 3948-132	7	7,9		RU 3949-020
				9	9,1		RU 3949-021
				12	10,3		RU 3949-022
				5	6,5		RU 3949-023
				7	7,2		RU 3949-024
				11	7,8		RU 3949-025
				5	5,5		RU 3949-026
				7	5,5		RU 3949-027
				11	5,5		RU 3949-028
				5	7,9		RU 3949-029
				7	8,8		RU 3949-030
				11	10,0		RU 3949-031

Gefäßclips für temporären Gebrauch sind durch gelb eingefärbte Federenden gekennzeichnet.
 Vessel clips for temporary occlusion are identified by yellow coloured spring ends.
 Clips vasculares, para oclusión temporaria, identificables mediante, resorte coloreado en amarillo.
 Les serre-fines d'usage temporaire sont marqués par des bouts de ressort colorés en jaune.
 Serrafini per uso temporaneo sono identificati con colore giallo sulla molla.