

Cardiovascular, Thorax, Lunge
Cardiovascular Surgery, Thorax, Lung
Cirugía cardiovascular, Thorax, Pulmon
Chirurgie cardiovasculaire, Thorax, Poumon
Chirurgia cardiovascolare, Toracoplastica,
Chirurgia polmonare

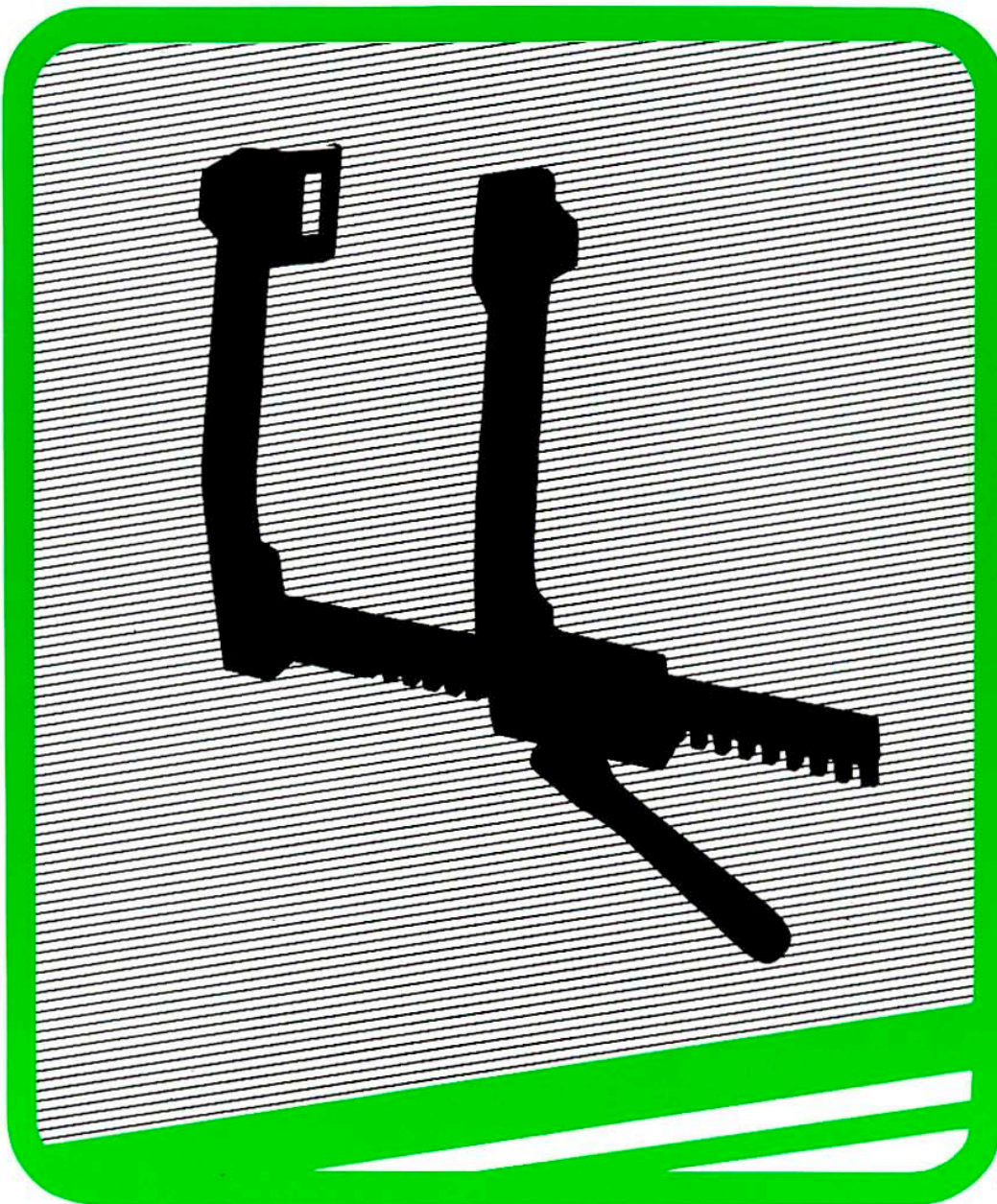

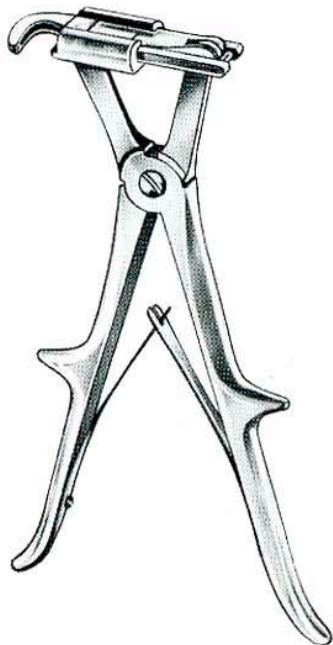

Rippenscheren, Sternumscheren, Sternummeißel
 Rib Shears, Sternum Scissors, Sternum Chisels
 Costotomos, Tijeras de esternón, Cinceles de esternón
 Costotomes, Cisailles et ciseau-burins à sternum
 Costotomi, Forbici e scalpello per sterno



Sauerbruch

24 cm/9¹/₂" RU 7500-24
 26 cm/10¹/₄" RU 7500-26

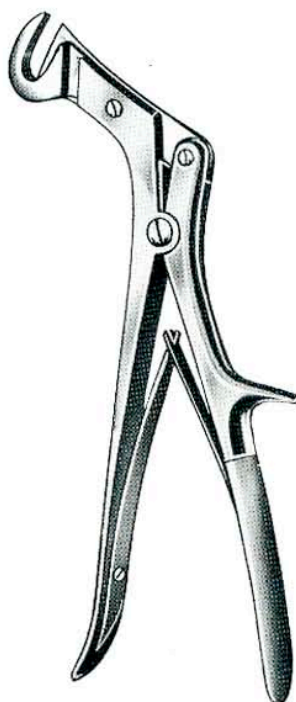

Giertz-Stille

27 cm/10¹/₂"
 RU 7501-27

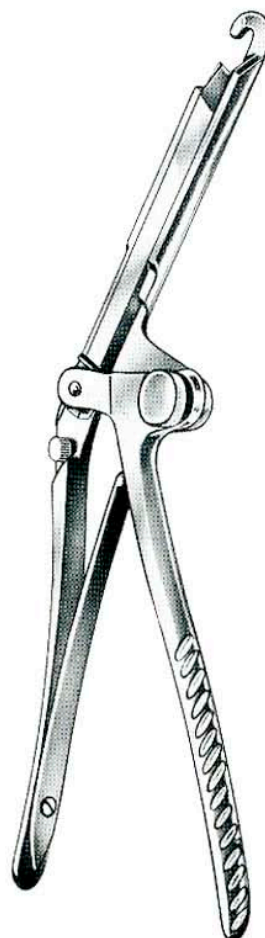

Sauerbruch-Frey

36 cm/14"
 RU 7502-36



Bethune

34 cm/13¹/₂"
 RU 7504-34

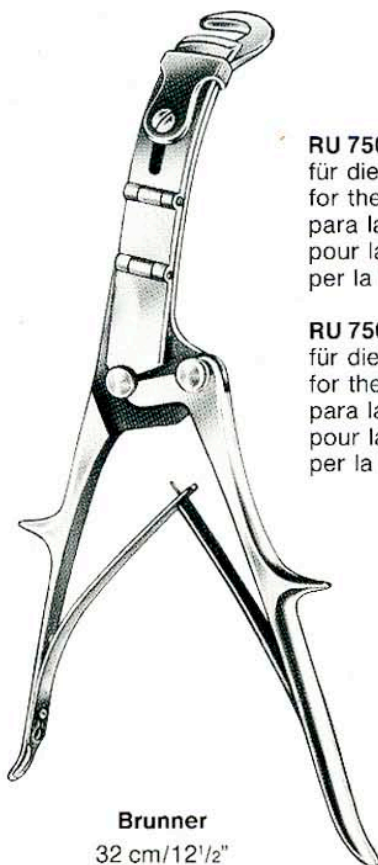

Brunner

32 cm/12¹/₂"

RU 7505-32

für die rechte Hand
 for the right hand
 para la mano derecha
 pour la main droit
 per la mano destra

RU 7506-32

für die linke Hand
 for the left hand
 para la mano izquierda
 pour la main gauche
 per la mano sinistra

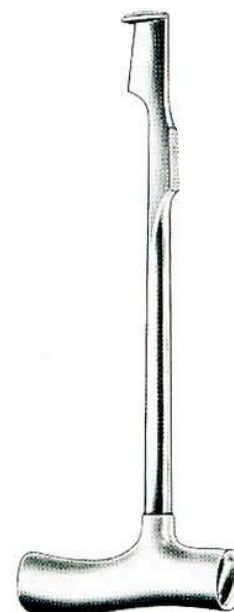

Lebsche

24,5 cm/9³/₄"
 RU 7507-24



Rippensperrer
Rib Spreaders
Separadores costales
Ecarteurs costaux
Divaricatori costali

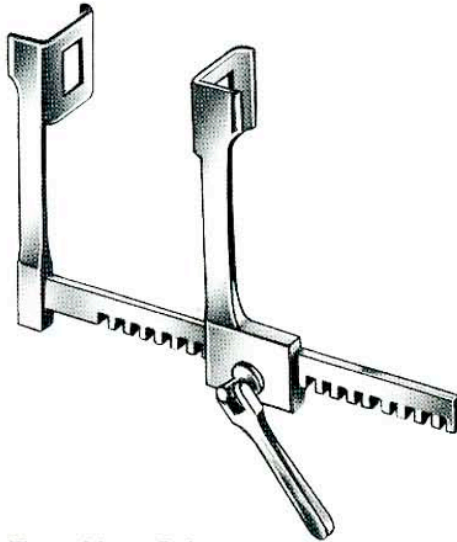

Finocchietto-Baby

	a	b	c
RU 7509-00	6 mm	7 mm	36 mm
RU 7510-00	18 mm	20 mm	80 mm

Abmessungs-Schema
 scheme of dimensions
 esquema de dimensiones
 schéma des dimensions
 schema per le dimensioni

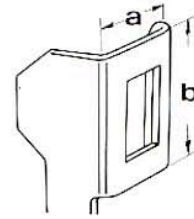

Größe der Valve
 size of blades
 tamaño de la valva
 dimensions des valves
 dimensioni delle valve

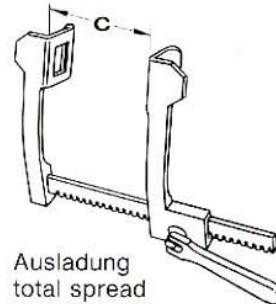

Ausladung
 total spread
 apertura total
 ouverture totale
 apertura totale



Finocchietto

	a	b	c
RU 7512-01	36 mm	45 mm	140 mm
RU 7512-03	44 mm	65 mm	200 mm
RU 7512-04	44 mm	65 mm	250 mm
RU 7512-05	44 mm	65 mm	300 mm
RU 7512-06	65 mm	65 mm	200 mm
RU 7512-07	65 mm	65 mm	250 mm
RU 7512-08	65 mm	65 mm	300 mm



Rippensperrer
Rib Spreaders
Separadores costales
Ecarteurs costaux
Divaricatori costali



mit 2 Paar auswechselbaren Valven
 with 2 pairs of interchangeable blades
 con 2 pares de valvas intercambiables
 avec 2 paires de valves interchangeables
 con 2 paia di valve

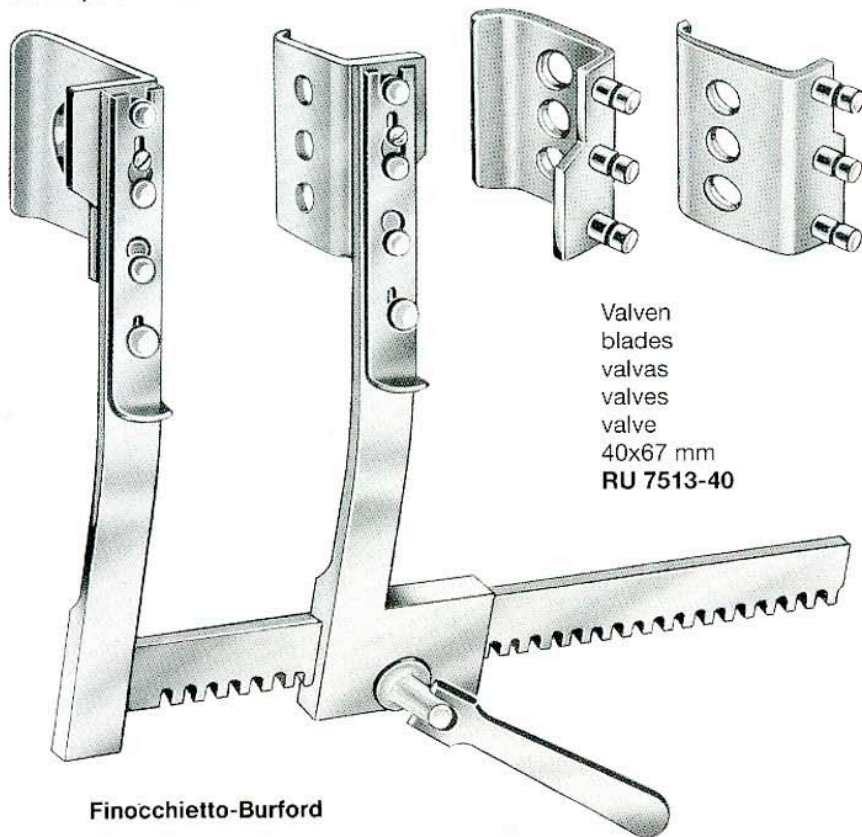

Finocchietto-Burford

Valven
 blades
 valvas
 valves
 valve
 40x67 mm
RU 7513-40

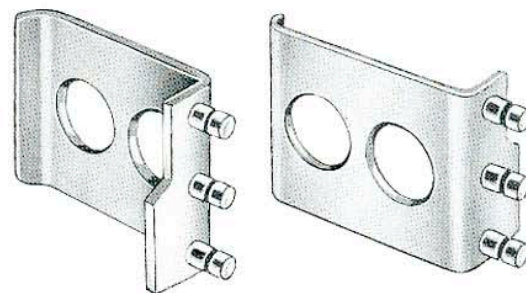

Valven
 blades
 valvas
 valves
 valve
 80x67 mm
RU 7513-41

Spreizweite
 total spread
 apertura total
 ouverture totale
 apertura totale

200 mm/8" **RU 7513-01**
 250 mm/10" **RU 7513-02**
 305 mm/12" **RU 7513-03**



Tuffier

	a	b	c
RU 7515-00	50 mm	45 mm	165 mm



Rippensperrer
 Rib Spreaders
 Separadores costales
 Ecarteurs costaux
 Divaricatori costali

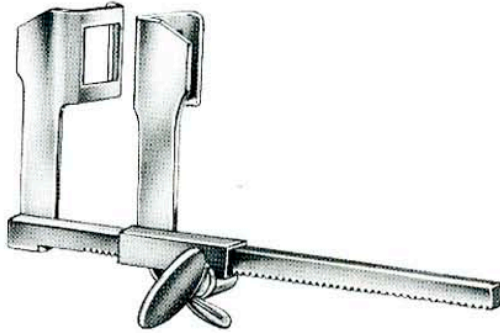

Haight

	a	b	c
RU 7516-00	30 mm	30 mm	115 mm

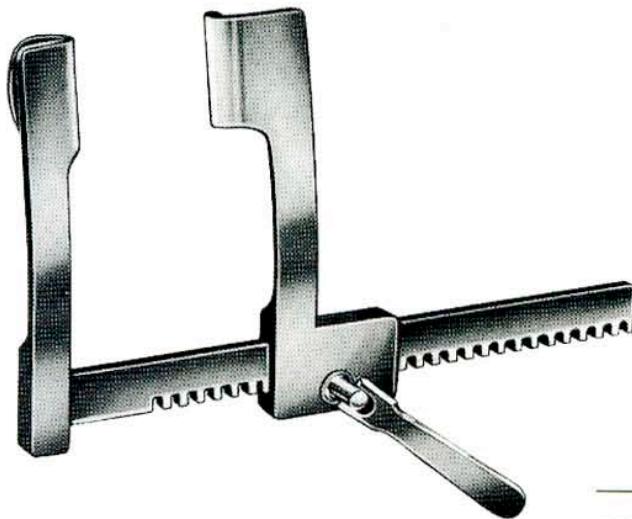

Cooley
 (Cooley-Baby)

	a	b	c
RU 7518-01	15 mm	30 mm	100 mm
RU 7518-02	21 mm	45 mm	145 mm
RU 7518-03	32 mm	50 mm	190 mm



**Rippensperrer
Rib Spreaders
Separadores costales
Ecarteurs costaux
Divaricatori costali**

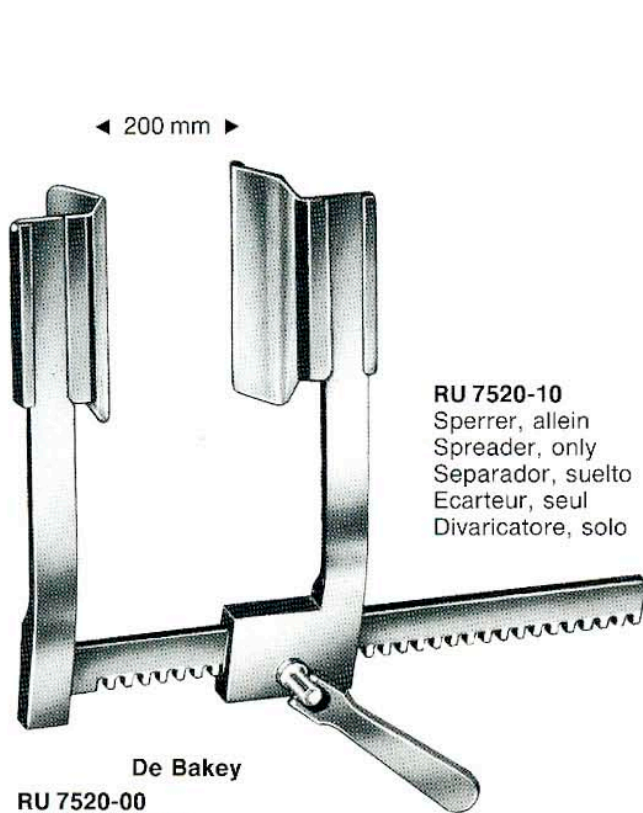

RU 7520-10
Sperrer, allein
Spreader, only
Separador, suelto
Ecarteur, seul
Divaricatore, solo

De Bakey
RU 7520-00
mit 3 Paar Blättern
with 3 pairs of blades
con 3 pares de valvas
avec 3 paires de valves
con 3 paia di valve
(RU 7520-21, RU 7520-22, RU 7520-23)



60x60 mm
RU 7520-21



50x80 mm
RU 7520-22



40x100 mm
RU 7520-23

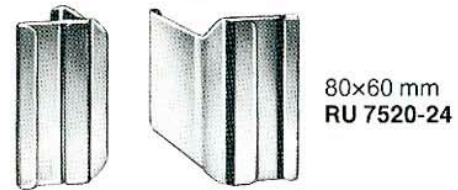

80x60 mm
RU 7520-24



50x66 mm
RU 7520-25

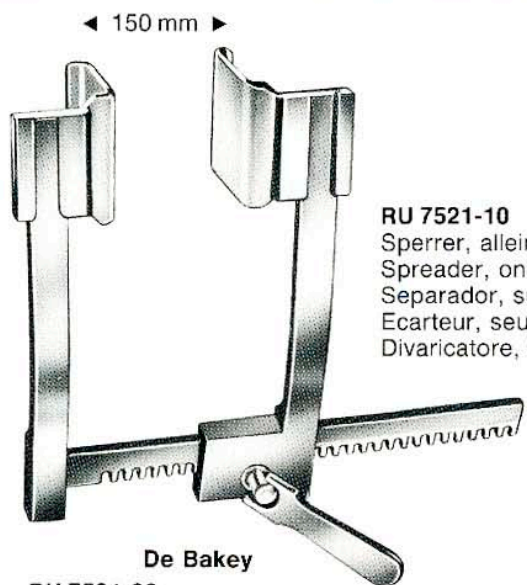

RU 7521-10
Sperrer, allein
Spreader, only
Separador, suelto
Ecarteur, seul
Divaricatore, solo

De Bakey
RU 7521-00
mit 3 Paar Blättern
with 3 pairs of blades
con 3 pares de valvas
avec 3 paires de valves
con 3 paia di valve



30x30 mm
RU 7521-21



40x40 mm
RU 7521-22



50x50 mm
RU 7521-23



**Rippensperrer
Rib Spreaders
Separadores costales
Ecarteurs costaux
Divaricatori costali**



Morse-Favaloro

	a	b	c
RU 7522-01	12 mm	20 mm	155 mm
RU 7522-02	40 mm	20 mm	155 mm

Thoraxsperrer
Thoracic retractor
Separador torácico
Ecarteur thoracique
Divaricatore per il torace

75x85 mm
RU 7523-21

48x65 mm
RU 7523-22

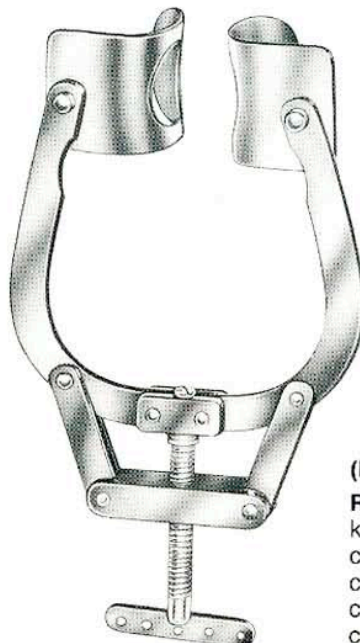

RU 7523-10
Sperrer, allein
Retractor, only
Separador, suelto
Ecarteur, seul
Divaricatore, solo

(Mercedes-Retractor)

RU 7523-00
komplett
complete
completo
complet
completo



Rippensperrer aus Leichtmetall
Rib Spreaders Made of Aluminium
Separadores costales de aluminio
Ecarteurs costaux en aluminium
Divaricatori costali in alluminio



Rudolf
ALU

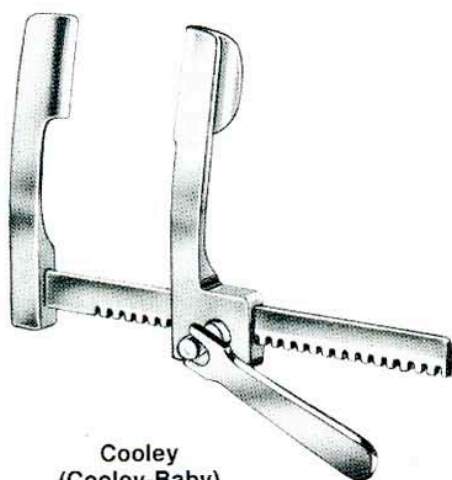

Cooley
(Cooley-Baby)

	a	b	c
RU 7524-01	15 mm	15 mm	70 mm
RU 7524-02	15 mm	30 mm	100 mm
RU 7524-04	30 mm	50 mm	185 mm

Rudolf
ALU

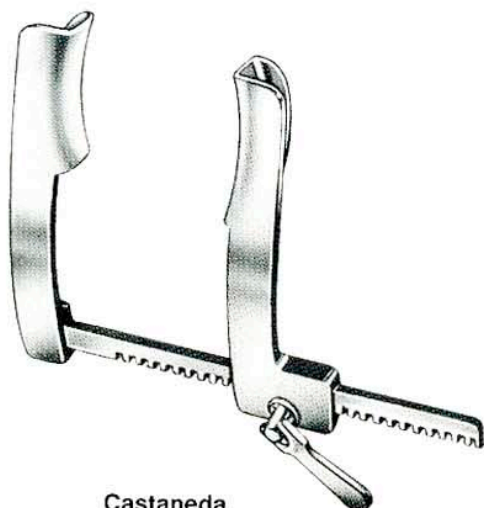

Castaneda

	a	b	c
RU 7525-01	12 mm	32 mm	70 mm
RU 7525-02	15 mm	45 mm	75 mm
RU 7525-03	15 mm	60 mm	100 mm

Rudolf
ALU

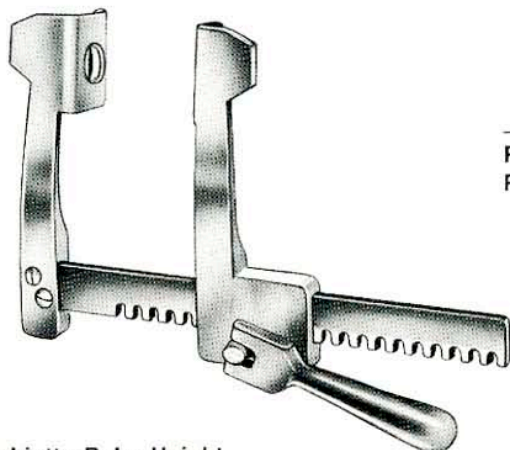

Finocchetto-Baby-Haight

	a	b	c
RU 7527-01	12 mm	15 mm	70 mm
RU 7527-02	27 mm	30 mm	95 mm



Rippensperrer aus Leichtmetall
 Rib Spreaders Made of Aluminium
 Separadores costales de aluminio
 Ecarteurs costaux en aluminium
 Divaricatori costali in alluminio



Rudolf
 ALU

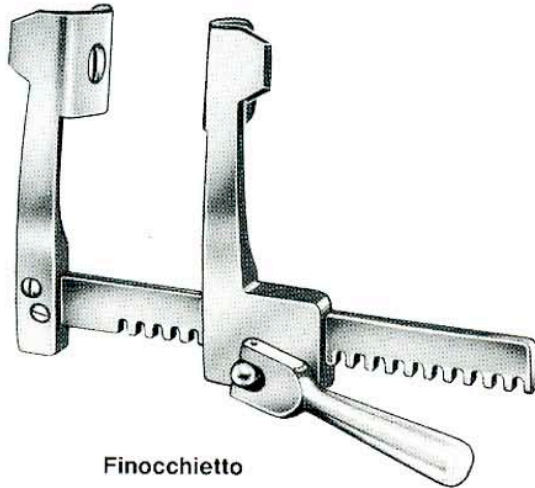

Finocchetto

	a	b	c
RU 7527-11	30 mm	45 mm	140 mm
RU 7527-12	40 mm	65 mm	175 mm
RU 7527-13	75 mm	65 mm	175 mm

Rudolf
 ALU



Burford
 mit 2 Paar Valven
 with 2 pairs of blades
 con 2 pares de valvas
 avec 2 paires de valves
 con 2 paia di valve

	a	b	c
für Kinder / for children / para niños pour enfants / per bambini			
RU 7528-00	48 mm 34 mm	42 mm 42 mm	135 mm 135 mm
RU 7528-01	67 mm 48 mm	62 mm 62 mm	180 mm
RU 7528-02	67 mm 48 mm	62 mm 62 mm	260 mm
RU 7528-03	67 mm 48 mm	62 mm 62 mm	300 mm



Rippenkontraktoren, Lungenspatel
Rib Contractors, Lung Spatulas
Aproximadores para costillas, Espátulas pulmonares
Rapprocheurs costaux, Spatules pulmonaires
Approssimatori costali, Spatole per polmone

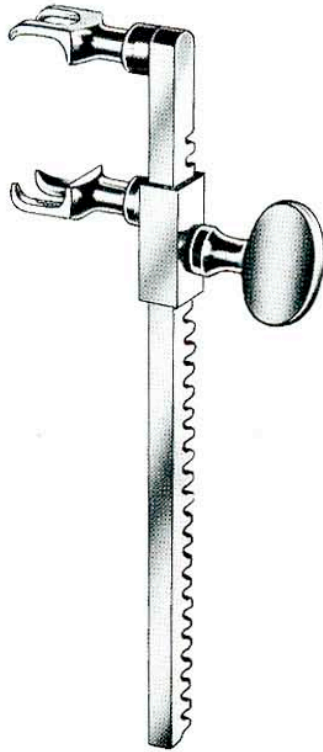

Sellors
 19 cm/7 1/2"
 RU 7533-19

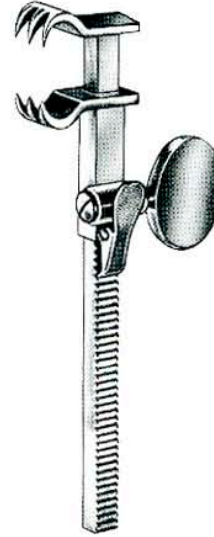

Bailey-Baby
 14 cm/5 1/2"
 RU 7534-14

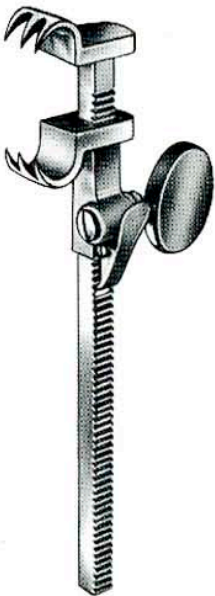

Bailey
 16 cm/6 1/4"
 RU 7536-16

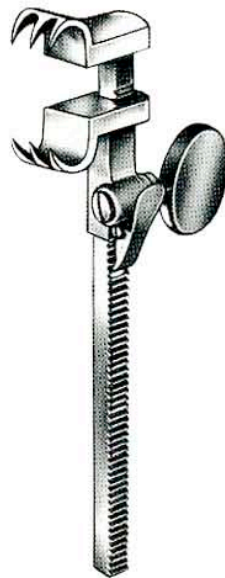

Bailey-Gibbon
 16 cm/6 1/4"
 RU 7537-16



Allison
 25,5 cm/10" RU 7538-25
 30 cm/12" RU 7538-30

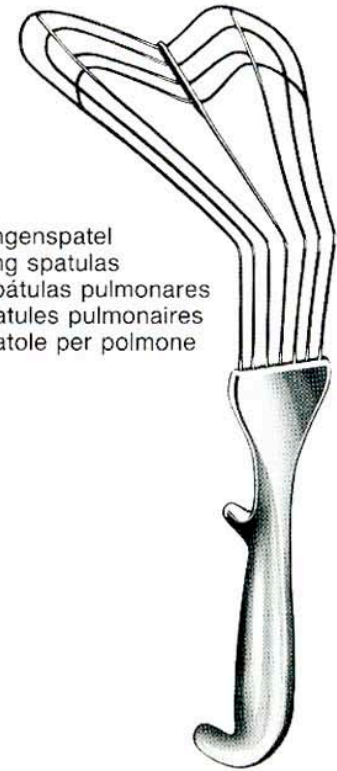

Lungenspatel
Lung spatulas
Espátulas pulmonares
Spatules pulmonaires
Spatole per polmone



Bronchusklemmen, Gefäßklemmen
Bronchus Clamps, Blood Vessel Clamps
Pinzas-clamps para bronquios y para vasos
Pinces-clamps à bronches, Pinces vasculaires
Pinze per bronchi, Pinze cardiovascolari

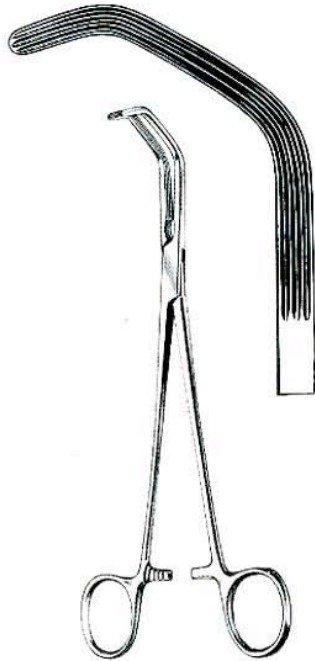
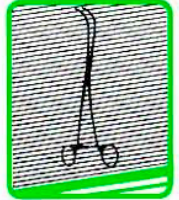

Price-Thomas
 22 cm/8³/₄"
 RU 7540-22

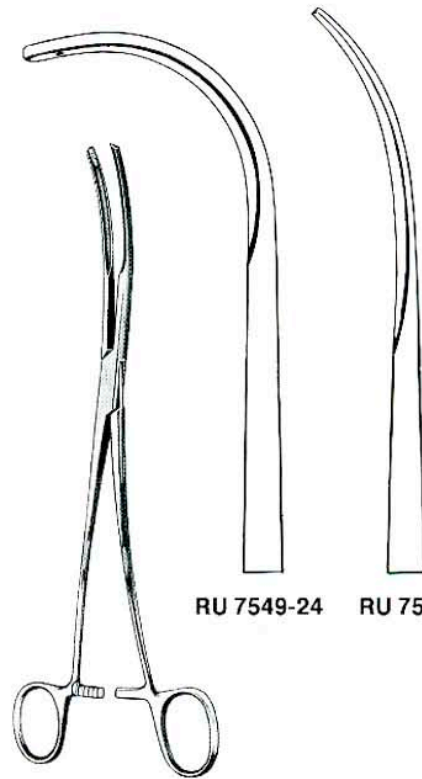

RU 7549-24 RU 7548-24

Semb
 24 cm/9¹/₂"

Lungenfaßzangen
 Lung grasping forceps
 Pinzas-clamps pulmonares
 Pinces-clamps à poumons
 Pinze per polmone



Lovelace
 20 cm/8"
 RU 7560-20



Lovelace
 20 cm/8"
 RU 7561-20

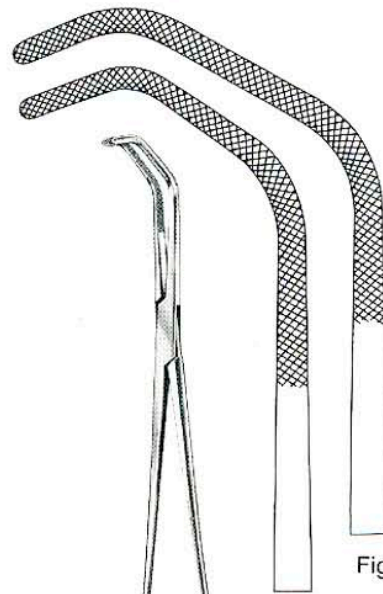
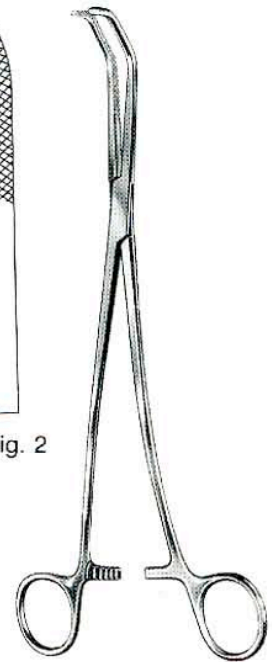

Fig.1

Fig. 2



RU 7566-01
 RU 7566-02



Satsky
 26,5 cm/10¹/₂"
 Fig. 1
 Fig. 2

RU 7567-01
 RU 7567-02

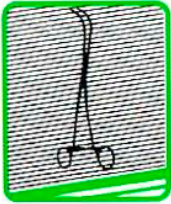

Gefäßklemmen
 Blood Vessel Clamps
 Clamps para vasos
 Pincers vasculaires
 Pinze cardiovascolari

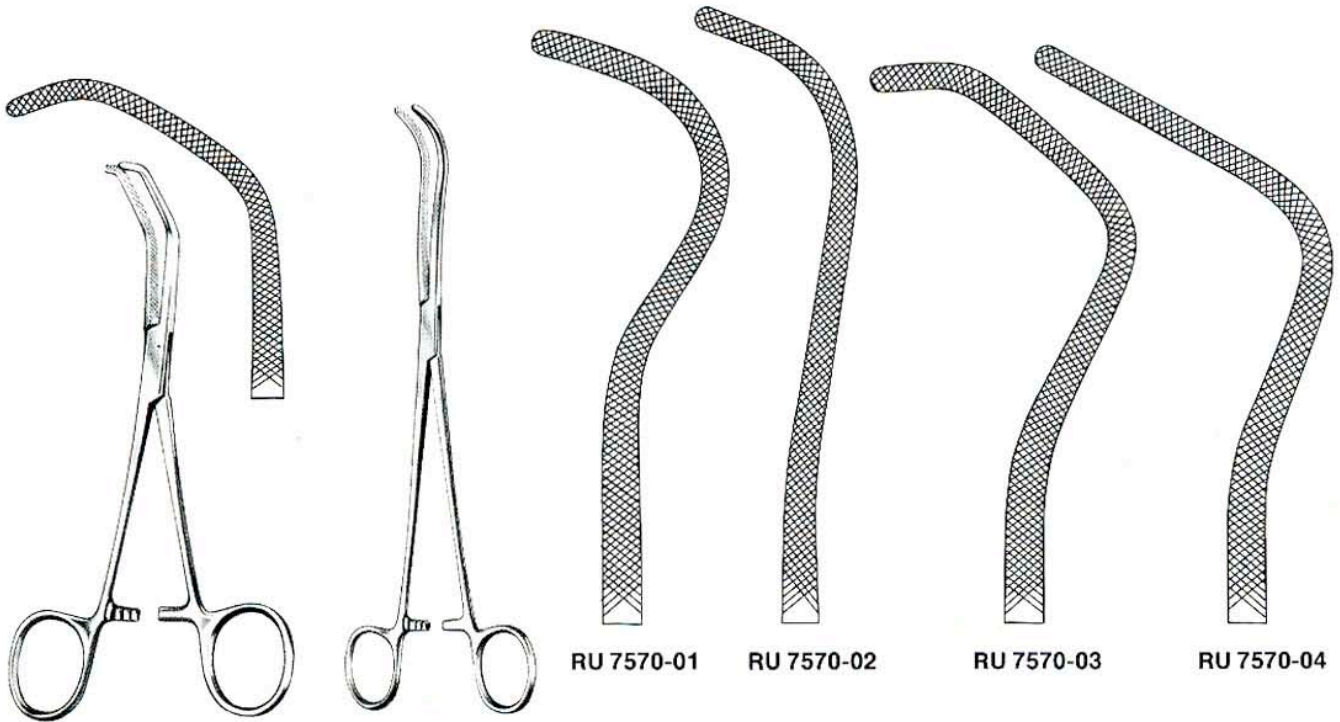

Baby-Satinsky
 15 cm/6"
 RU 7568-15

Harken
 24 cm/9 1/2"

RU 7570-01

RU 7570-02

RU 7570-03

RU 7570-04

Atrauma-Pinzetten
 Atrauma tissue forceps
 Pinzas de disección atrauma
 Pincers atraumatiques
 Pinze atraumatiche

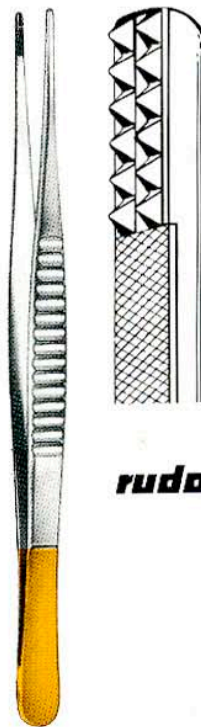

rudolf atrauma

rudolf TC

breit
 wide
 ancho
 largeur
 larghe

De Bakey

	1,5 mm	2,0 mm	2,7 mm	3,5 mm
15 cm/6"	RU 7571-15/15	RU 7571-20/15	RU 7571-27/15	RU 7571-35/15
19,5 cm/7 1/2"	RU 7571-15/19	RU 7571-20/19	RU 7571-27/19	RU 7571-35/19
24 cm/9 1/2"	RU 7571-15/24	RU 7571-20/24	RU 7571-27/24	RU 7571-35/24



Atrauma-Pinzetten
 Atrauma Forceps
 Pinzas de disección Atrauma
 Pincès atraumatiques
 Pinze cardiovascolari Atraumatiche

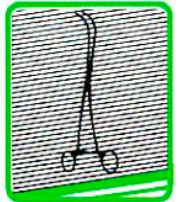

De Bakey

breit
 wide
 ancho
 largeur
 larghe

	1,2 mm	2,0 mm
18 cm/7"	RU 7575-12/18	RU 7575-20/18
21 cm/8 1/4"	RU 7575-12/21	RU 7575-20/21

Titan

18 cm/7"	RU 7575-12/18TI	RU 7575-20/18TI
----------	-----------------	-----------------

rudolf atrauma



Cooley

15 cm/6"	RU 7579-15
19,5 cm/7 1/2"	RU 7579-19

2,0 mm



De Bakey

breit
 wide
 ancho
 largeur
 larghe

	1,5 mm	2,0 mm	2,7 mm	3,5 mm
16 cm/6 1/4"	RU 7580-16	RU 7581-16	RU 7582-16	RU 7583-16
20 cm/8"	RU 7580-20	RU 7581-20	RU 7582-20	RU 7583-20
24 cm/9 1/2"	RU 7580-24	RU 7581-24	RU 7582-24	RU 7583-24
30 cm/12"	RU 7580-30	RU 7581-30	RU 7582-30	RU 7583-30

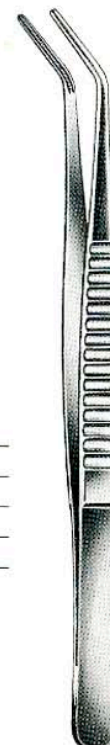

De Bakey

breit
 wide
 ancho
 largeur
 larghe

2,0 mm	RU 7584-16
	RU 7584-20
	RU 7584-24
	RU 7584-30

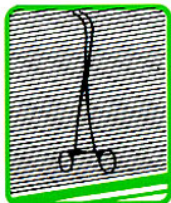

Atrauma Bulldogklemmen
Atrauma Bulldog Clamps
Clamps Bulldog atraumaticos
Clamps atraumatiques Bulldog
Pinze atraumatiche Bulldog



Anlegezange für
 Setting forceps for
 Pinzas para poner clips para
 Pince pour poser les clips pour
 Pinza per applicare clips per
RU 7586-07 - 7586-12
RU 7587-07 - 7587-12

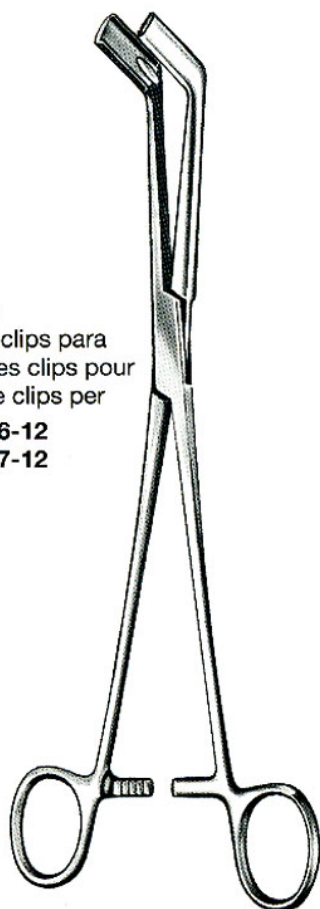

23 cm/9"
RU 7586-00



De Bakey

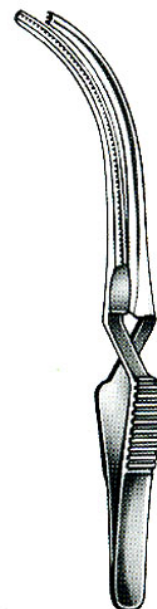

RU 7586-07	8 cm/3"	RU 7587-07
RU 7586-08	9 cm/3 1/2"	RU 7587-08
RU 7586-10	10,5 cm/4"	RU 7587-10
RU 7586-12	13,0 cm/5"	RU 7587-12



De Bakey



3,5 cm/1 1/2"
RU 7586-10/35



3,5 cm/1 1/2"
RU 7586-11/35



4,5 cm/1 3/4"
RU 7586-10/45



4,5 cm/1 3/4"
RU 7586-11/45



De Bakey
 5,0 cm/2"
RU 7586-10/50



De Bakey
 4,5 cm/1 3/4"
RU 7586-11/50



Atrauma Bulldogklemmen
 Atrauma Bulldog Clamps
 Clamps Bulldog atraumaticos
 Clamps atraumatiques Bulldog
 Pinze atraumatiche Bulldog

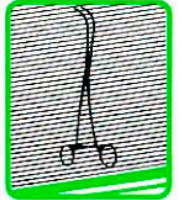

De Bakey

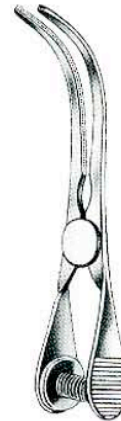
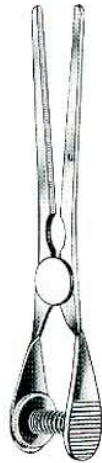

Glover

RU 7588-06	6 cm/2½"	5,5 cm/2"	RU 7589-06
RU 7588-07	7 cm/2¾"	6,5 cm/2½"	RU 7589-07
RU 7588-09	8,5 cm/3½"	8 cm/3"	RU 7589-09
RU 7588-11	13 cm/5"	12,5 cm/5"	RU 7589-11

Glover



Glover
 5 cm/2"
 RU 7590-05

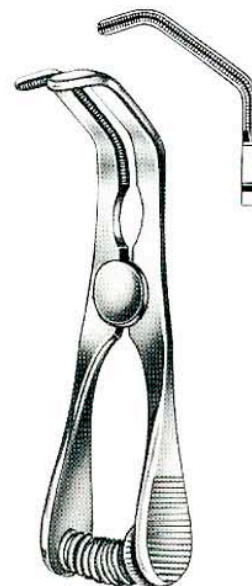

De Bakey-Satinsky
 7 cm/2¾"
 RU 7590-07

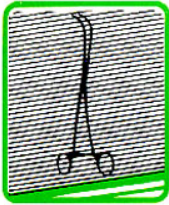

Atrauma Bulldogklemmen
Atrauma Bulldog Clamps
Clamps Bulldog atraumaticos
Clamps atraumatiques Bulldog
Pinze atraumatiche Bulldog



De Bakey

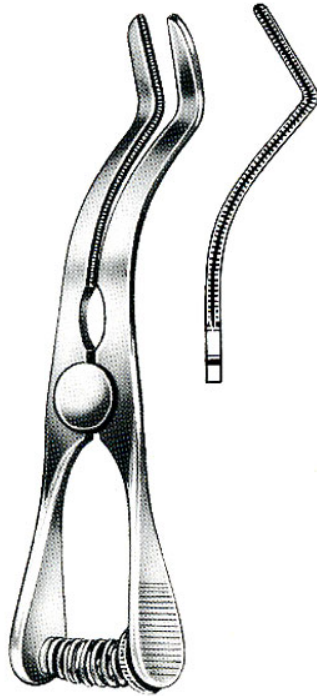

De Bakey
 8 cm/3¼"
 RU 7590-09

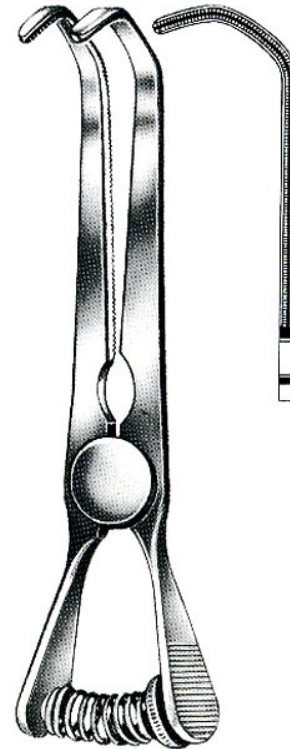

De Bakey
 10,5 cm/4¼"
 RU 7590-10

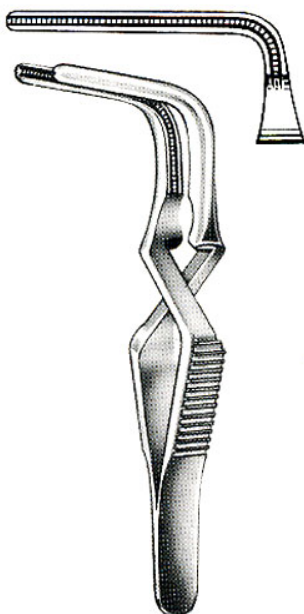

Santulli
 7 cm/2¾"
 RU 7591-07

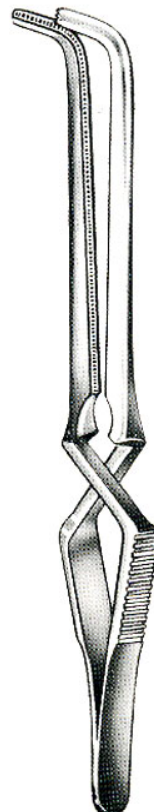

Gregory-Soft
 11 cm/4½" 12 cm/4¾"
 RU 7591-09 RU 7591-11

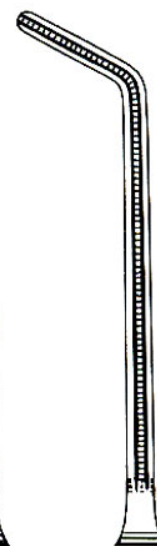



Atrauma Bulldogklemmen
Atrauma Bulldog Clamps
Clamps Bulldog atraumaticos
Clamps atraumatiques Bulldog
Pinze atraumatiche Bulldog

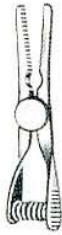
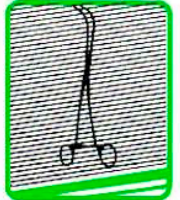

3 cm/1¹/₄"
RU 7592-02/30V
RU 7592-02/30A

Vena
Arteria



3,5 cm/1¹/₂"
RU 7592-02/35V
RU 7592-02/35A



4 cm/1¹/₂"
RU 7592-02/40V
RU 7592-02/40A



5 cm/2"
RU 7592-02/50V
RU 7592-02/50A

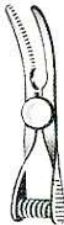

3 cm/1¹/₄"
RU 7592-03/30V
RU 7592-03/30A

Vena
Arteria



3,5 cm/1¹/₂"
RU 7592-03/35V
RU 7592-03/35A



4 cm/1¹/₂"
RU 7592-03/40V
RU 7592-03/40A



5 cm/2"
RU 7592-03/50V
RU 7592-03/50A

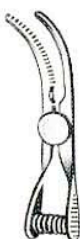

3 cm/1¹/₄"
RU 7592-05/30V
RU 7592-05/30A

Vena
Arteria



3,5 cm/1¹/₂"
RU 7592-05/35V
RU 7592-05/35A



4 cm/1¹/₂"
RU 7592-05/40V
RU 7592-05/40A

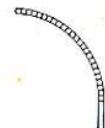

5 cm/2"
RU 7592-05/50V
RU 7592-05/50A

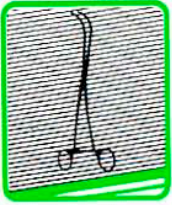



Atrauma Cardiovascular-Klemmen
Atrauma Cardiovascular Forceps
Atrauma Pinzas-clamps cardiovasculares
Pinces vasculaires atraumatiques
Pinze cardiovascolari Atraumatiche

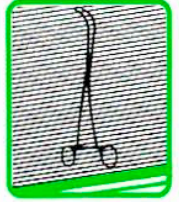

Zahnung nach De Bakey:

Die ATRAUMA-Klemmen mit Tradition. Neben Herz- und Gefäß-Chirurgie auch für andere atraumatische Anwendungsbereiche und Operationstechniken bewährt. Unverrückbares, exaktes Fassen des Gewebes, sicheres und fein dosierbares Abklemmen der Gefäße.

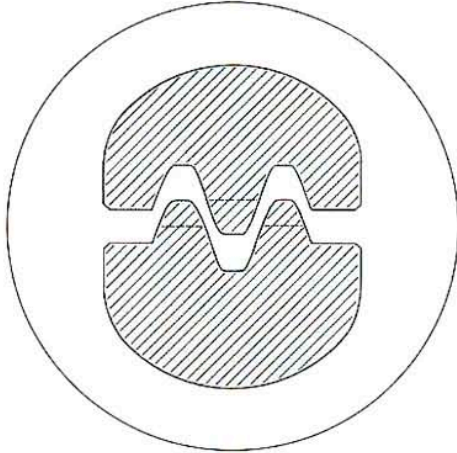

Toothing according to De Bakey:

The traditional ATRAUMA clamps. Apart from cardiovascular surgery, they are also approved for other atraumatic application and surgery techniques. Firm and precise seizing of tissues, safe and delicately controlled clamping effect.

Dentado según De Bakey:

Pinzas ATRAUMA tradicionales. Probadas no sólo en la cirugía cardiovascular, sino también en otros sectores de aplicaciones y técnicas de operación. Clampaje firme y exacto del tejido, «clamping» seguro de los vasos.

Denture d'après De Bakey:

Le clamp ATRAUMA traditionnel. Eprouvé dans la chirurgie du thorax et vasculaire de même que dans d'autres domaines et pour d'autres techniques opératoires non-traumatisantes. Préhension parfaite et exacte du tissu, clampage sûr des vaisseaux.

Dentatura secondo De Bakey:

Le pinze ATRAUMA a lunga tradizione. Eccellenti risultati sia nella chirurgia cardiaca e vascolare che anche in altri campi di applicazione e di tecniche operative atraumatiche. Presa fissa ed esatta dei vasi.

Zahnung nach Cooley:

Durch die sehr schmalen Maulteile einsetzbar in extrem begrenztem Operationsfeld. Besonders bei Säuglings- und Herzchirurgie. Fester Griff ohne Quetschungen.

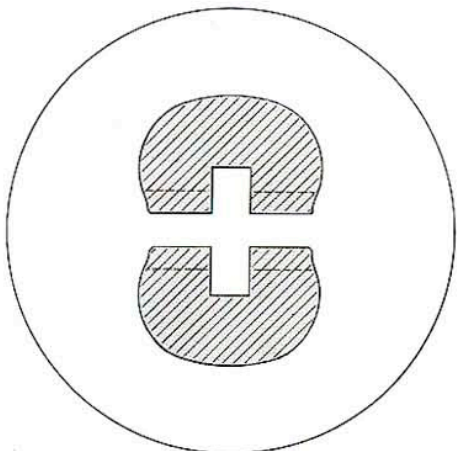

Toothing according to Cooley:

Very narrow jaws for application in extremely limited operational field. Particularly approved for cardiovascular surgery and pediatry. Firm grip without squeezing.

Dentado según Cooley:

Debido a la boca muy estrecha se puede aplicar en campos operativos extremadamente pequeños. Especialmente para cirugía infantil y del corazón. Clampaje fuerte sin contusiones.

Denture d'après Cooley:

Les mors très étroits permettent d'intervenir dans des parties extrêmement limitées du champ opératoire. En particulier pour la chirurgie cardiovasculaire et infantile. Prise sûre sans écrasement.

Dentatura secondo Cooley:

I becchi sottilissimi permettono l'uso in campi operativi estremamente limitati, soprattutto nella chirurgia cardiaca e infantile. Presa sicura senza contusioni.

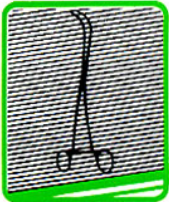

Atrauma Cardiovascular-Klemmen
Atrauma Cardiovascular Forceps
Atrauma Pinzas-clamps cardiovasculares
Pinces vasculaires atraumatiques
Pinze cardiovascolari Atraumatiche



De Bakey

Coarctations-Klemmen
 Coarctation clamps
 Pinzas clamps
 para coartación
 Pinces-clamps
 pour la coarctation
 Pinze per
 coartazione

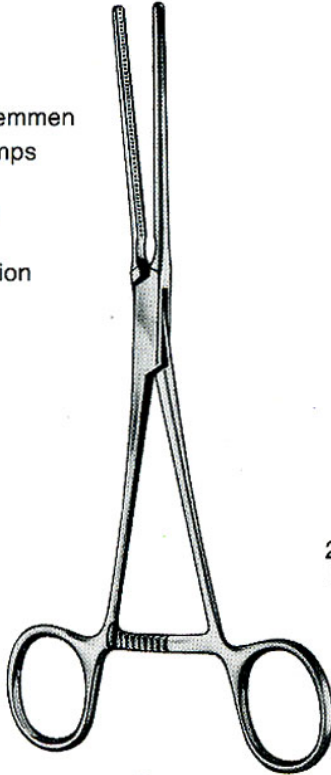

**Potts
(De Bakey)**



21,5 cm/8¹/₂"
 RU 7600-21



22,5 cm/9"
 RU 7600-22

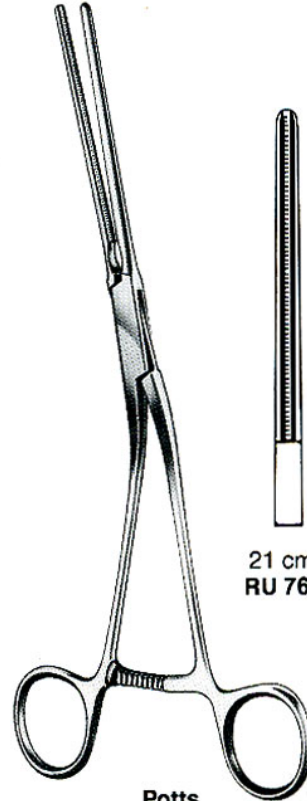

**Potts
(De Bakey)**



21 cm/8¹/₄"
 RU 7601-21



22 cm/8³/₄"
 RU 7601-22

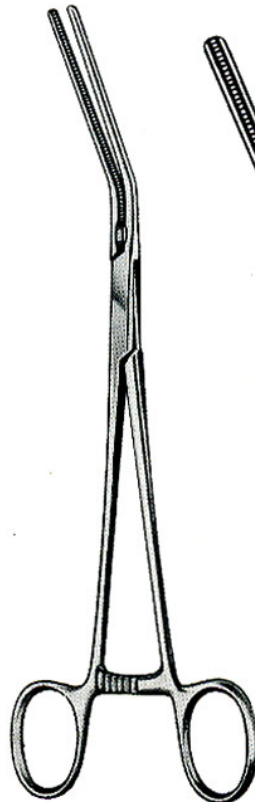

Potts

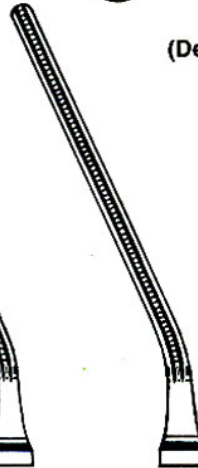

21 cm/8¹/₄"
 RU 7602-21

22 cm/8³/₄"
 RU 7602-22



Atrauma Cardiovascular-Klemmen
 Atrauma Cardiovascular Forceps
 Atrauma Pinzas-clamps cardiovasculares
 Pinces vasculaires atraumatiques
 Pinze cardiovascolari Atraumatiche

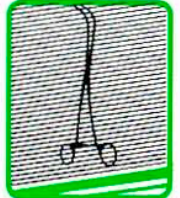

De Bakey

Anastomosen-Klemmen
 Anastomosis clamps
 Pinzas-clamps para anastomosis
 Pinces-clamps pour l' anastomose
 Pinze per anastomosi

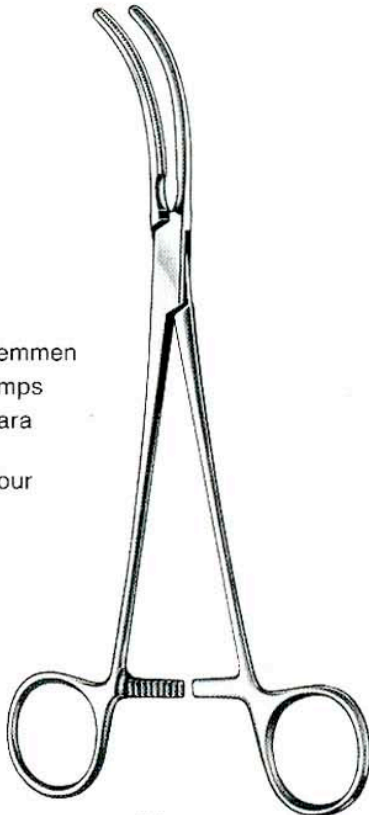

Glover
(Potts)

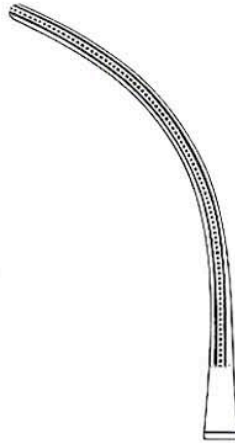

21 cm/8¹/₄"
 RU 7603-21



21 cm/8¹/₄"
 RU 7604-21

Präparier- und Ligaturklemmen
 Dissecting and ligature forceps
 Pinzas para preparaciones y ligaduras
 Pinces à préparation et ligature
 Pinze per preparazioni e legature

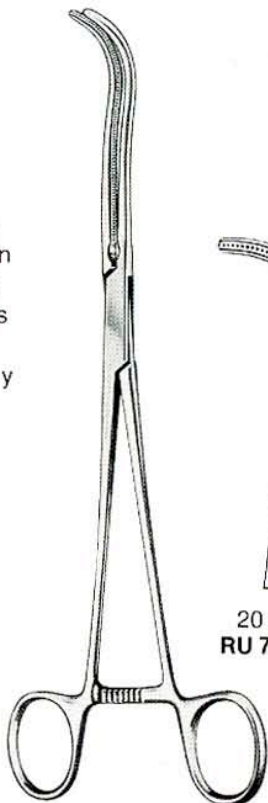

De Bakey



20 cm/8"
 RU 7605-20

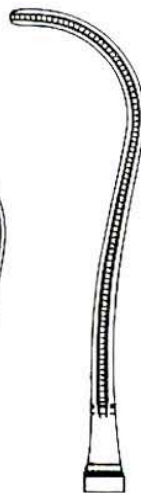

22 cm/8³/₄"
 RU 7605-24



De Bakey

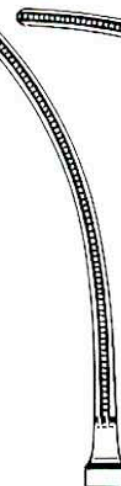

19 cm/7¹/₂"
 RU 7609-20

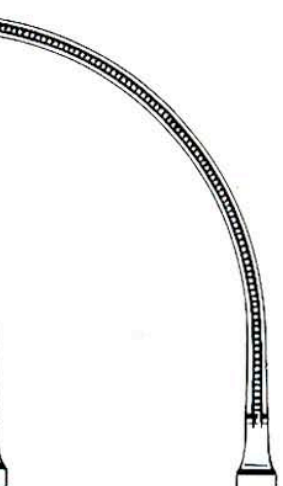

18 cm/7"
 RU 7609-19

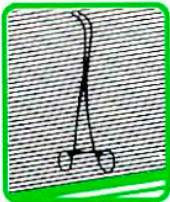

Atrauma Cardiovascular-Klemmen
 Atrauma Cardiovascular Forceps
 Atrauma Pinzas-clamps cardiovasculares
 Pincés vasculaires atraumatiques
 Pinze cardiovascolari Atraumatiche



De Bakey

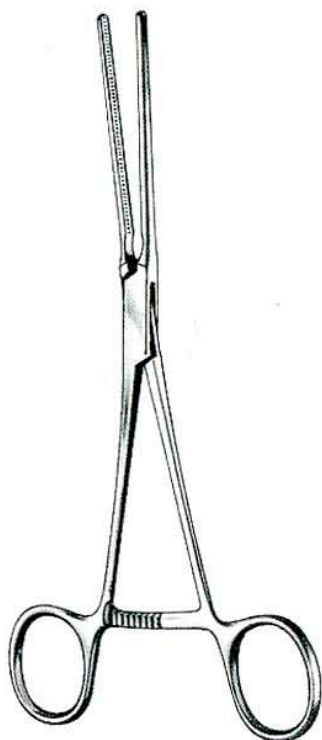

Leland-Jones

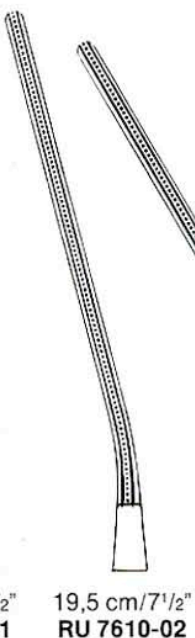

Leland-Jones
 18 cm/7"
 RU 7611-18

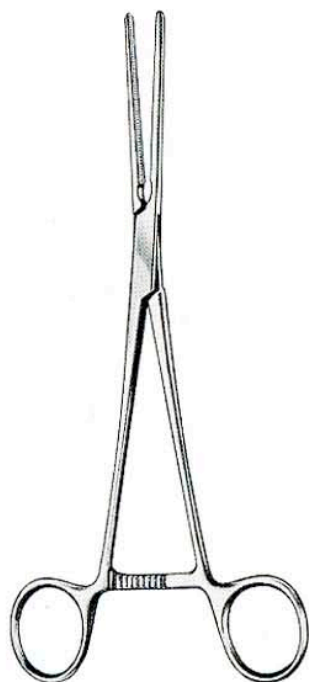

De Bakey-Bainbridge

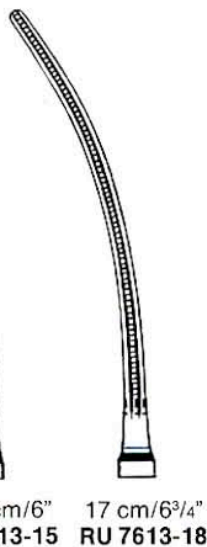
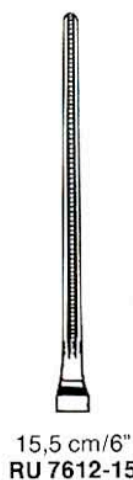

De Bakey
 23 cm/9"
 RU 7615-20



Atrauma Cardiovascular-Klemmen
Atrauma Cardiovascular Forceps
Atrauma Pinzas-clamps cardiovasculares
Pincas vasculaires atraumatiques
Pinze cardiovascolari Atraumatiche

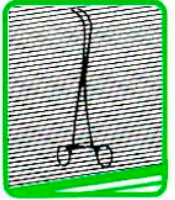

De Bakey

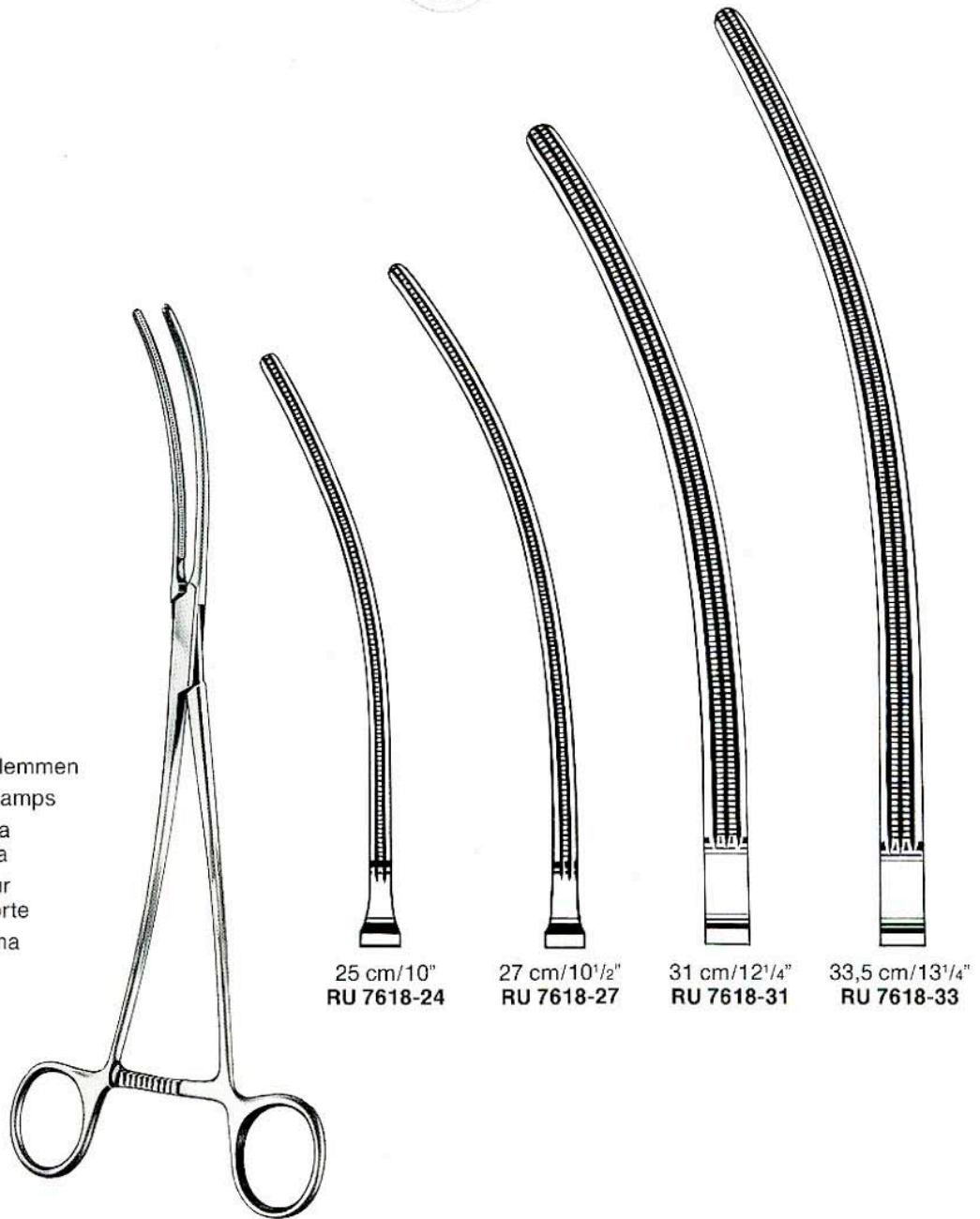

Aorta-Aneurysmaklemmen
Aortic aneurysm clamps
Pinzas-clamps para
aneurisma de aorta
Pincas-clamps pour
l'anévrisme de l'aorte
Pinze per aneurisma
dell' aorta

25 cm/10"
RU 7618-24

27 cm/10¹/₂"
RU 7618-27

31 cm/12¹/₄"
RU 7618-31

33,5 cm/13¹/₄"
RU 7618-33

De Bakey

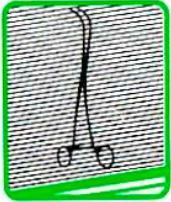

Atrauma Cardiovascular-Klemmen
Atrauma Cardiovascular Forceps
Atrauma Pinzas-clamps cardiovasculares
Pinces vasculaires atraumatiques
Pinze cardiovascolari Atraumatiche



De Bakey



Aorta-Aneurysmaklemmen
Aortic aneurysm clamps
Pinzas-clamps para
aneurisma de aorta
Pinces-clamps pour
l'anévrisme de l'aorte
Pinze per aneurisma
dell' aorta

De Bakey
28 cm/11"
RU 7620-28

31 cm/12 1/4"
RU 7621-30



Atrauma Cardiovascular-Klemmen
Atrauma Cardiovascular Forceps
Atrauma Pinzas-clamps cardiovasculares
Pinces vasculaires atraumatiques
Pinze cardiovascolari Atraumatiche

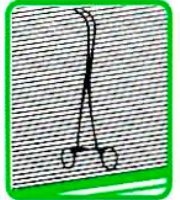

De Bakey

Aortaklemmen
Aortic clamps
Pinzas-clamps para aorta
Pinces-clamps pour l'aorte
Pinze per aorta

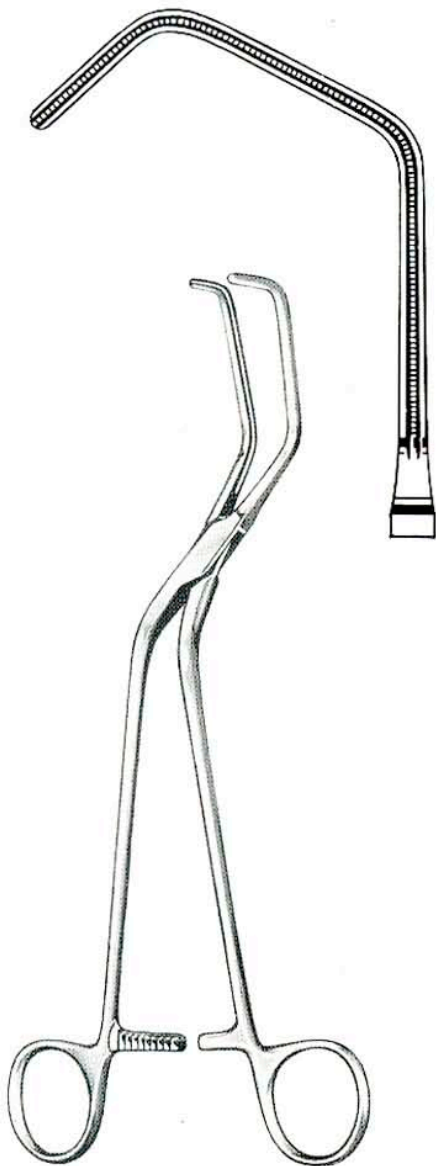

Ochsner
23,5 cm/9¹/₄"
RU 7624-23

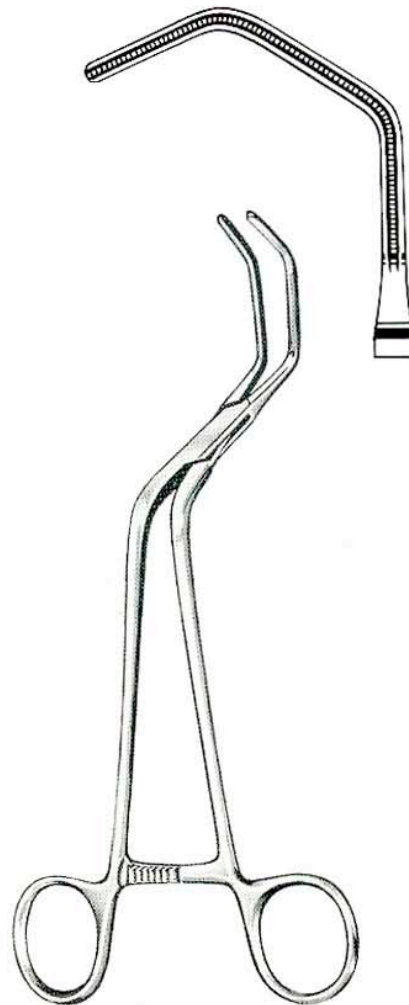

Dietrich
21 cm/8¹/₄"
RU 7625-21

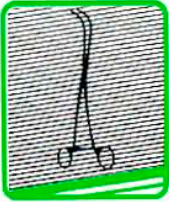

Atrauma Cardiovascular-Klemmen
 Atrauma Cardiovascular Forceps
 Atrauma Pinzas-clamps cardiovasculares
 Pincés vasculaires atraumatiques
 Pinze cardiovascolari Atraumatiche



De Bakey

Aurikelklemmen
 Auricle clamps
 Pinzas-clamps auriculares
 Pincés-clamps auriculaires
 Pinze per padiglione
 auricolare



25 cm/10"
 RU 7627-01

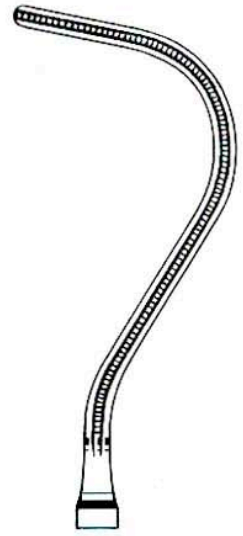

24 cm/9 1/2"
 RU 7627-02



Harken

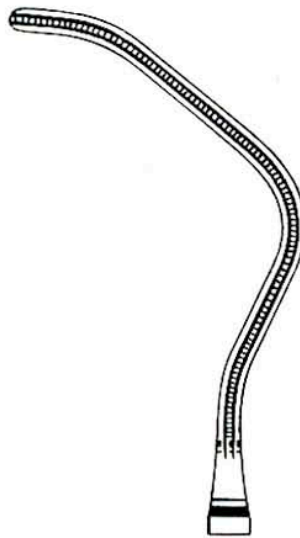

24 cm/9 1/2"
 RU 7627-03

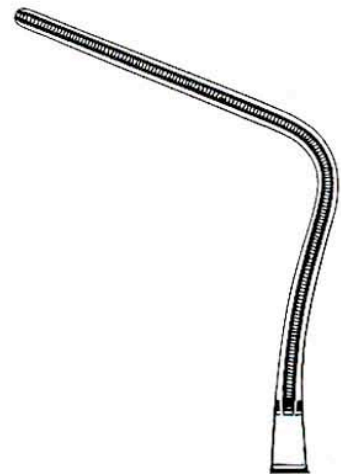

24 cm/9 1/2"
 RU 7627-04



Atrauma Cardiovascular-Klemmen
Atrauma Cardiovascular Forceps
Atrauma Pinzas-clamps cardiovasculares
Pincés vasculaires atraumatiques
Pinze cardiovascolari Atraumatiche

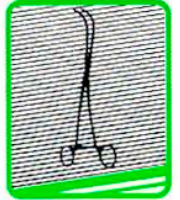

De Bakey

Bronchusklemmen
Bronchus clamps
Pinzas-clamps bronquiales
Pincés-clamps bronchiques
Pinze per bronchi



Lees



Lees
25 cm/10"
RU 7630-25

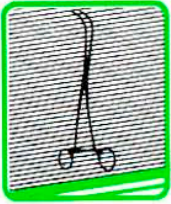

Atrauma Cardiovascular-Klemmen
Atrauma Cardiovascular Forceps
Atrauma Pinzas-clamps cardiovasculares
Pinces vasculaires atraumatiques
Pinze cardiovascolari Atraumatiche



De Bakey

Aortaklemme
 Aortic clamp
 Pinzas-clamps para aorta
 Pince-clamp pour l'aorte
 Pinze per aorta

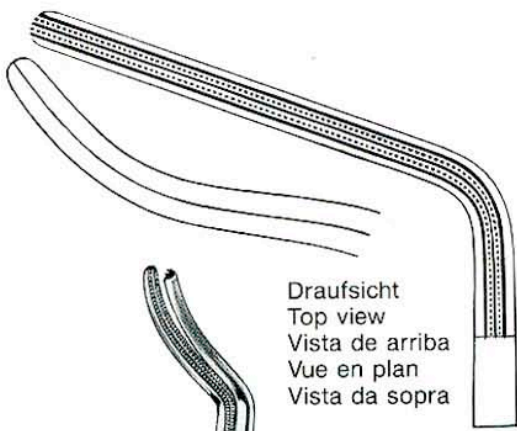

Draufsicht
 Top view
 Vista de arriba
 Vue en plan
 Vista da sopra

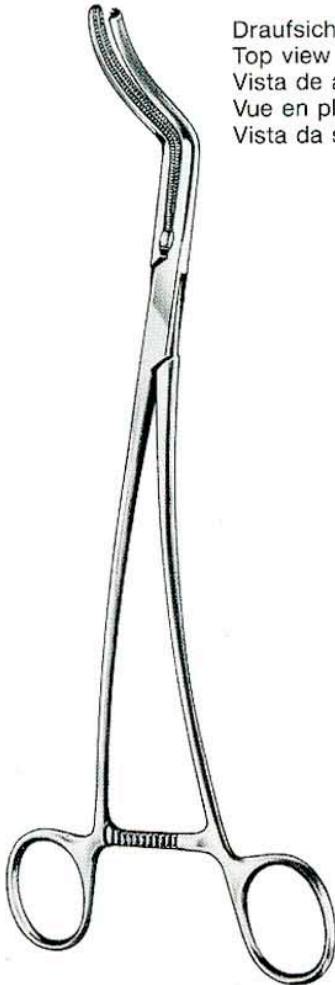

De Bakey
 27 cm/10 1/2"
 RU 7632-27

Ligaturklemmen
 Ligature clamps
 Pinzas-clamps para ligadura
 Pinces-clamps pour la ligature
 Pinze per legature

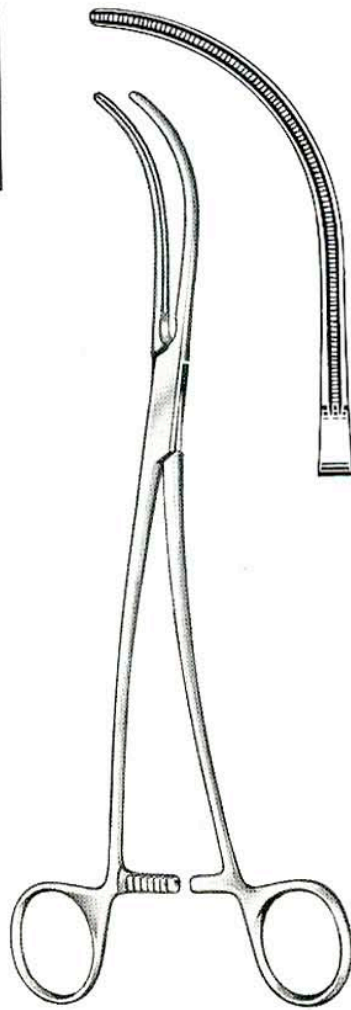

De Bakey
 24 cm/9 1/2"
 RU 7633-24

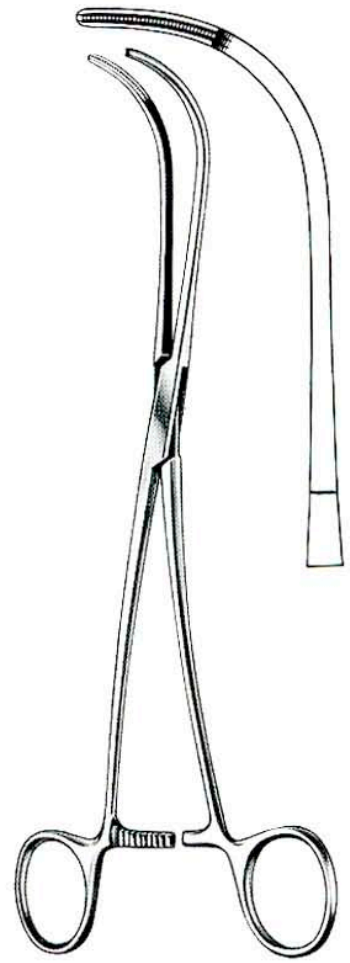

De Bakey
 24 cm/9 1/2"
 RU 7634-24



Atrauma Cardiovascular-Klemmen
Atrauma Cardiovascular Forceps
Atrauma Pinzas-clamps cardiovasculares
Pinces vasculaires atraumatiques
Pinze cardiovascolari Atraumatiche

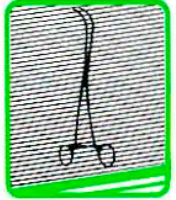

Ligaturklemme,
Aortaklemme
Ligature clamp,
Aortic clamp
Pinzas-clamps para ligadura y aorta
Pinces-clamps pour l'aorta et la ligature
Pinze per legature

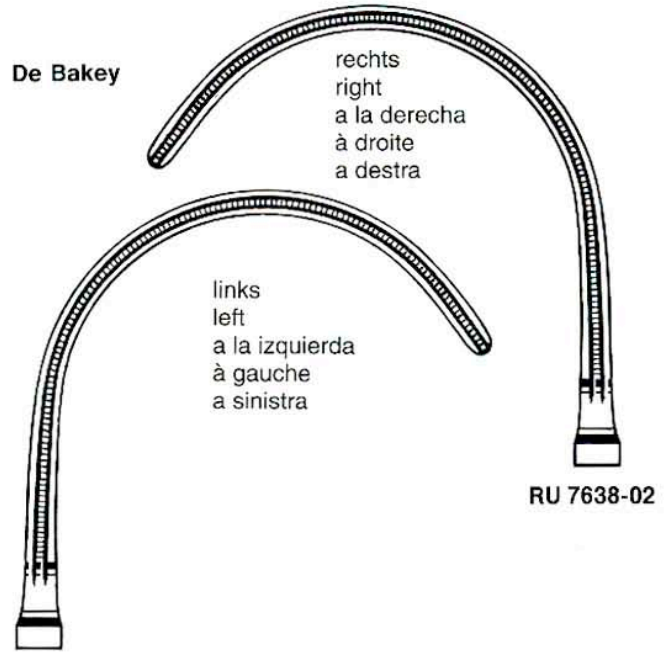
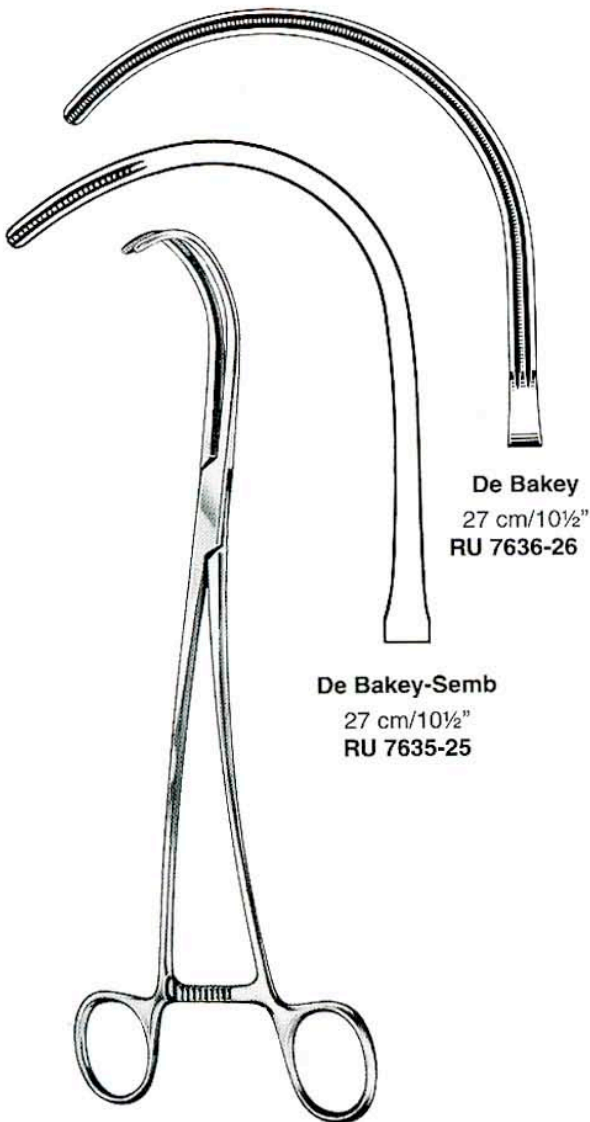

RU 7638-01

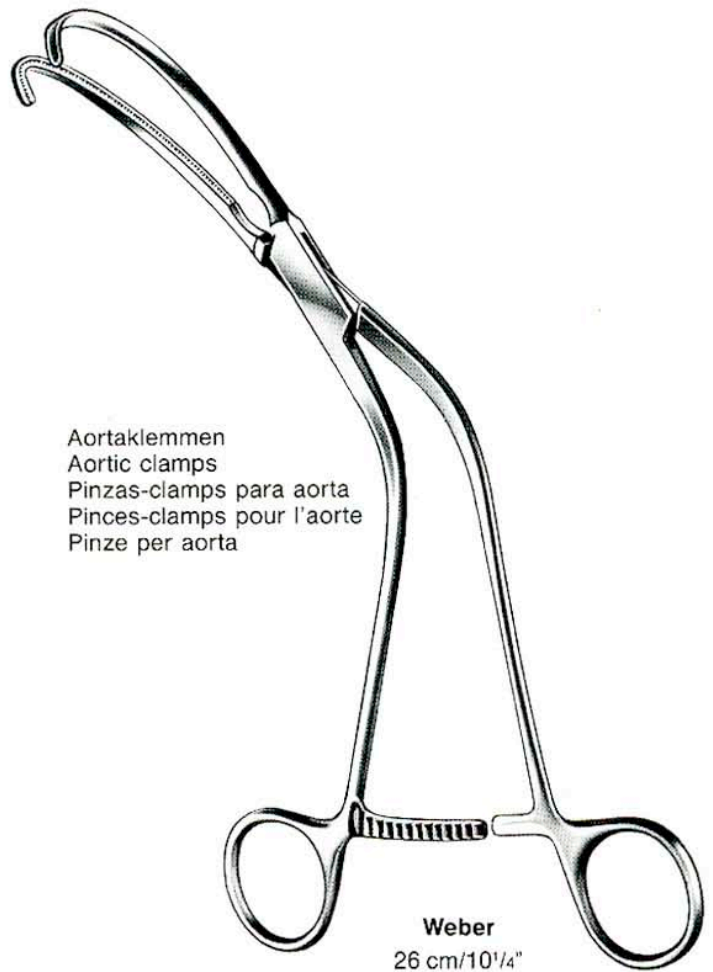

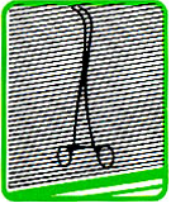

Atrauma Cardiovascular-Klemmen
Atrauma Cardiovascular Forceps
Atrauma Pinzas-clamps cardiovasculares
Pinces vasculaires atraumatiques
Pinze cardiovascolari Atraumatiche

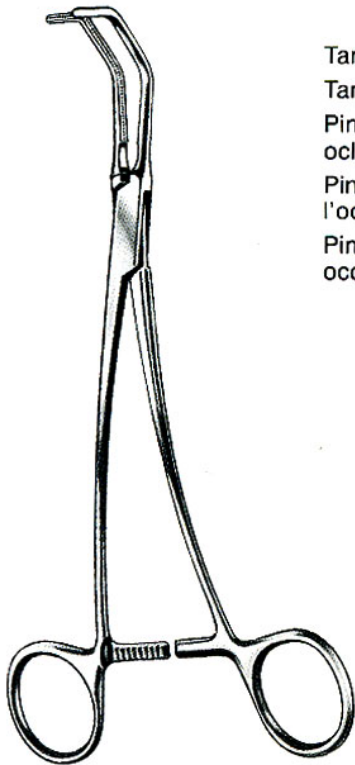

Satinsky - De Bakey

Tangentialklemmen
 Tangential occlusion clamps
 Pinzas-clamps para
 oclusión tangencial
 Pinces-clamps pour
 l'occlusion tangentielle
 Pinze per
 occlusione tangenziale



De Bakey

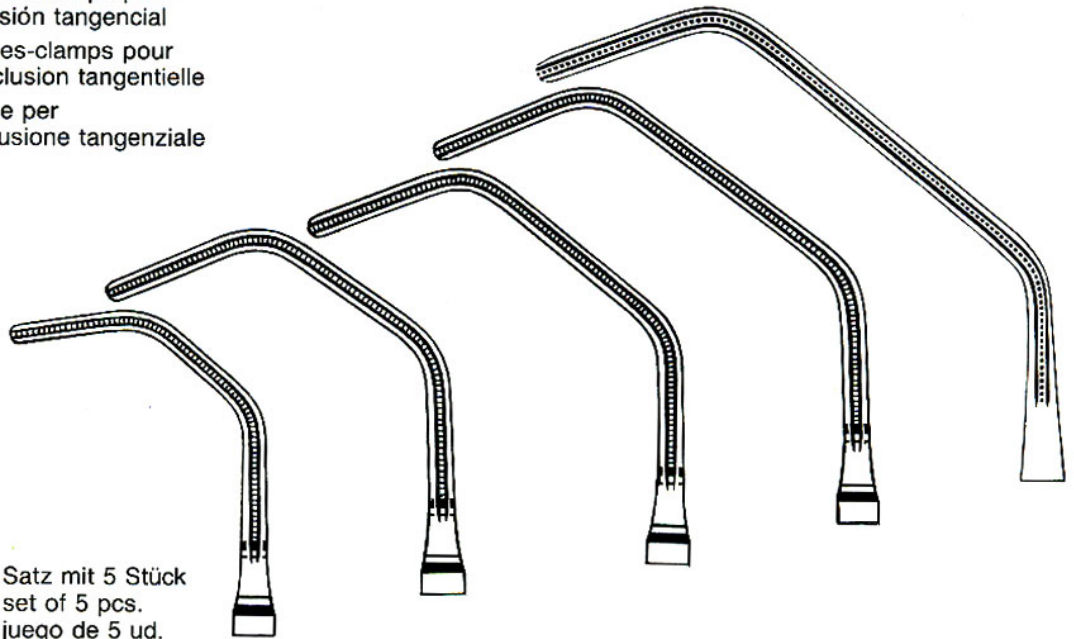

Satz mit 5 Stück
 set of 5 pcs.
 juego de 5 ud.
 jeu de 5
 set di 5

RU 7640-00	20 cm/8"	25 cm/10"	26 cm/10 ¹ / ₄ "	27 cm/10 ¹ / ₂ "	28 cm/11"
RU 7640-20	RU 7640-25	RU 7640-26	RU 7640-27	RU 7640-28	



Glover

RU 7646-01	19,5 cm/7 ³ / ₄ "
RU 7646-02	21 cm/8 ¹ / ₄ "

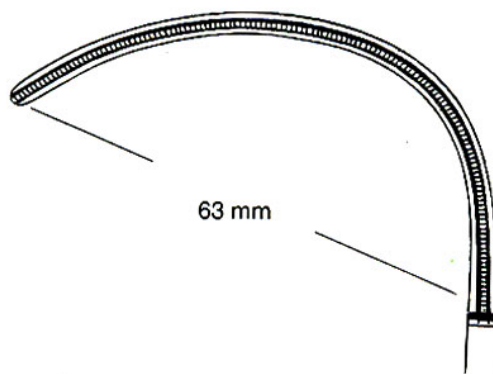

RU 7646-02

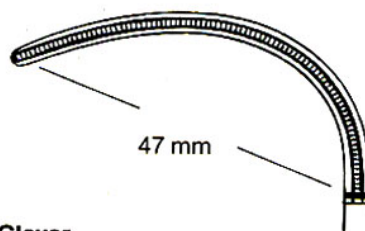

RU 7646-01

Anastomosenklemmen
 Anastomosis clamps
 Pinzas-clamps para anastomosis
 Pinces-clamps pour l'anastomose
 Pinze per anastomosi



Atrauma Cardiovascular-Klemmen
Atrauma Cardiovascular Forceps
Atrauma Pinzas-clamps cardiovasculares
Pinces vasculaires atraumatiques
Pinze cardiovascolari Atraumatiche

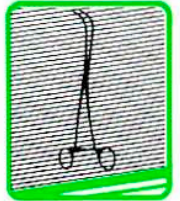

De Bakey

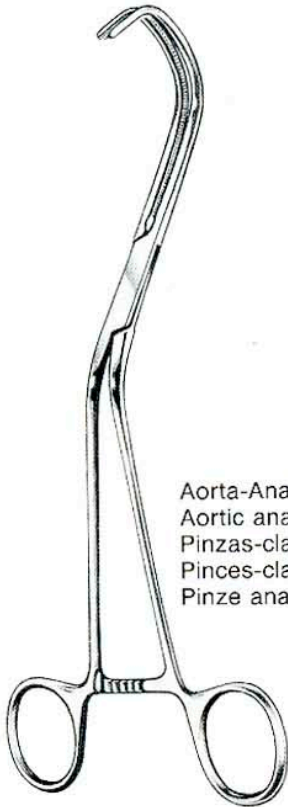

Lambert-Kay
21 cm/8¹/₄"

Aorta-Anastomosenklemmen
Aortic anastomosis clamps
Pinzas-clamps para anastomosis
Pinces-clamps pour l'anastomose de l'aorte
Pinze anastomosi aorta

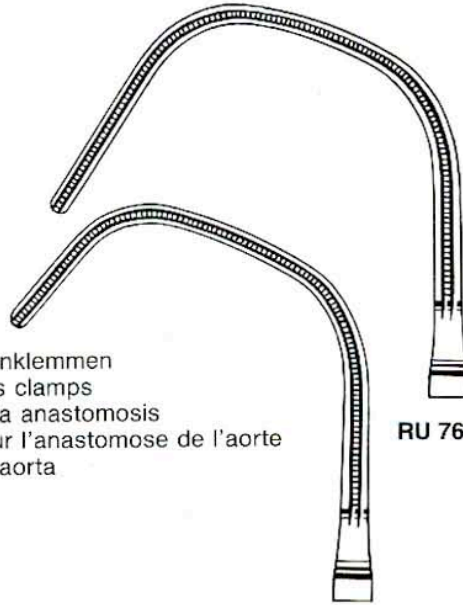

RU 7648-21

RU 7647-21

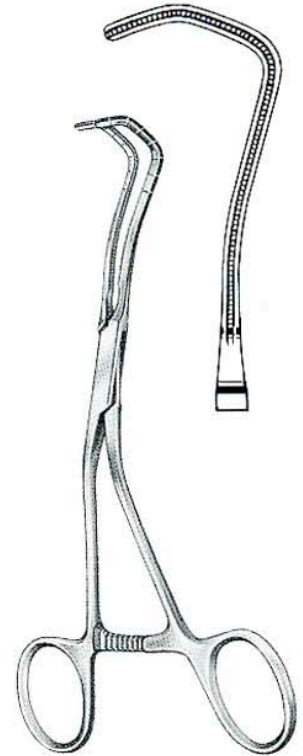

De Bakey
17 cm/6³/₄"
RU 7649-17

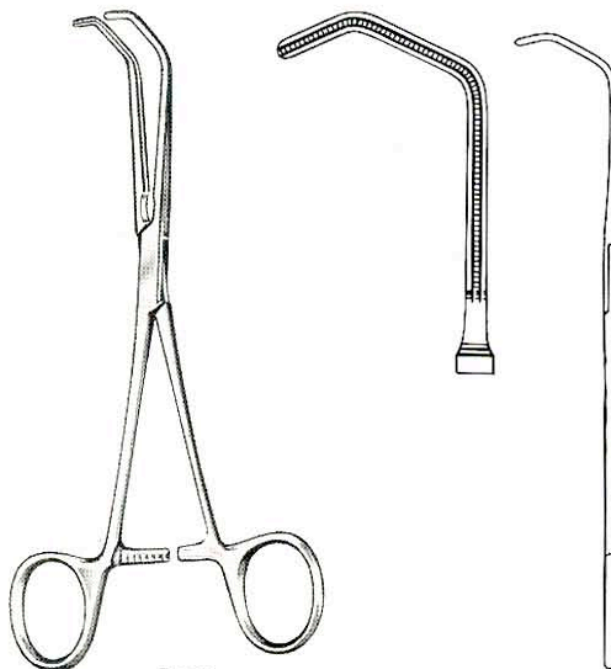

Beck
16 cm/6¹/₄"
RU 7650-17

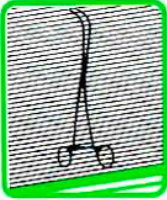

Atrauma Cardiovascular-Klemmen
Atrauma Cardiovascular Forceps
Atrauma Pinzas-clamps cardiovasculares
Pinces vasculaires atraumatiques
Pinze cardiovascolari Atraumatiche



De Bakey

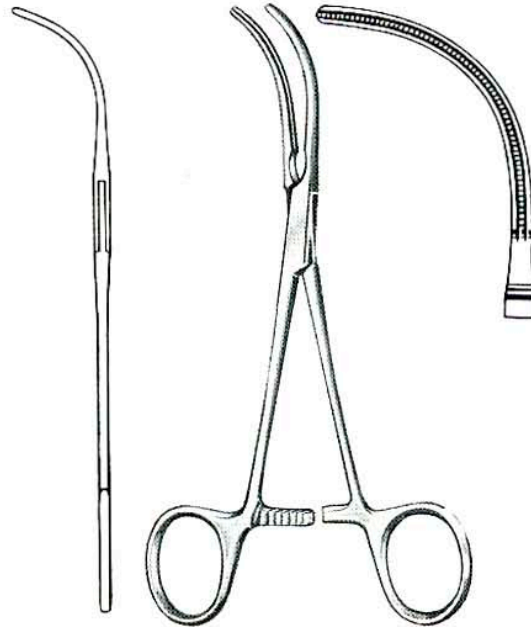

De Bakey
 16 cm/6 1/4"
 RU 7651-16

graduirt
 graduated
 graduada
 graduée
 graduata

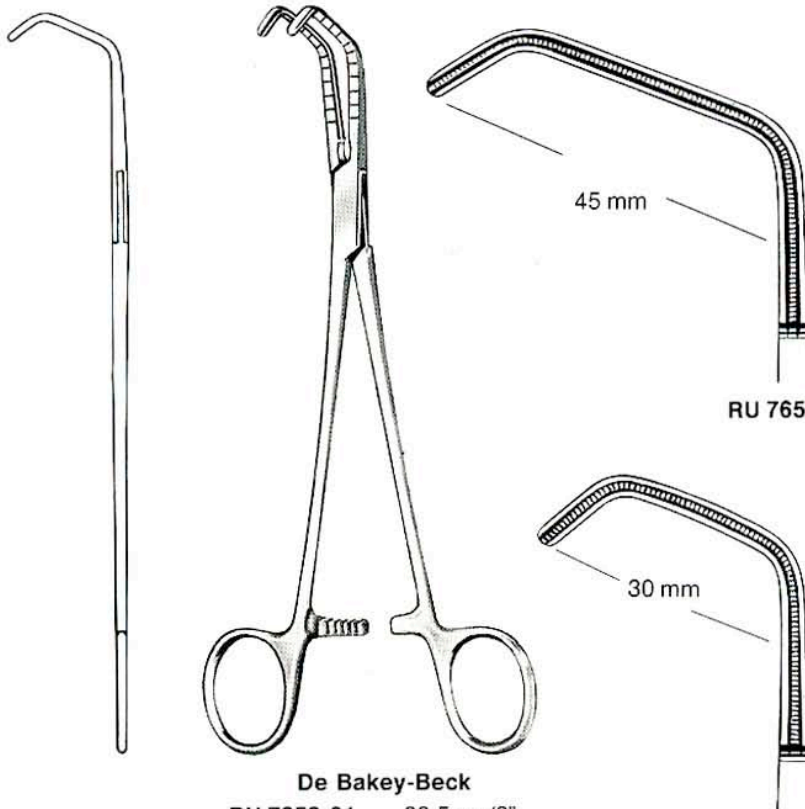

De Bakey-Beck

RU 7653-01 20,5 cm/8"
RU 7653-02 21 cm/8 1/4"

RU 7653-02

RU 7653-01



Atrauma Cardiovascular-Klemmen
Atrauma Cardiovascular Forceps
Atrauma Pinzas-clamps cardiovasculares
Pinces vasculaires atraumatiques
Pinze cardiovascolari Atraumatiche

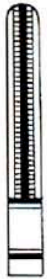
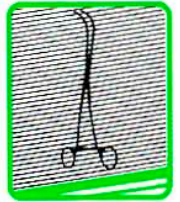

RU 7657-00



15°
RU 7657-15

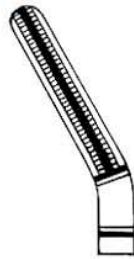

30°
RU 7657-30

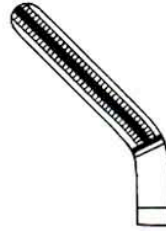

45°
RU 7657-45

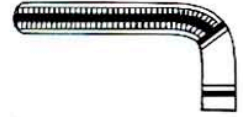

90°
RU 7657-90



RU 7658-00

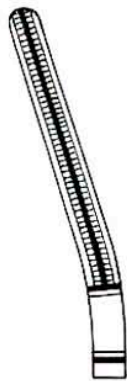

15°
RU 7658-15

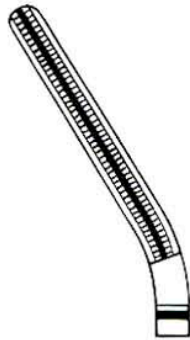

30°
RU 7658-30

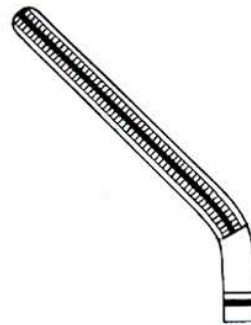

45°
RU 7658-45

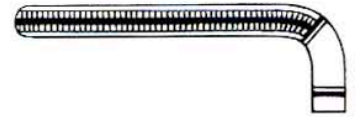

90°
RU 7658-90



Dardik

13 cm – 17 cm/5" – 6³/₄"

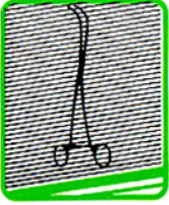

Atrauma Cardiovascular-Klemmen
Atrauma Cardiovascular Forceps
Atrauma Pinzas-clamps cardiovasculares
Pinces vasculaires atraumatiques
Pinze cardiovascolari Atraumatiche



De Bakey

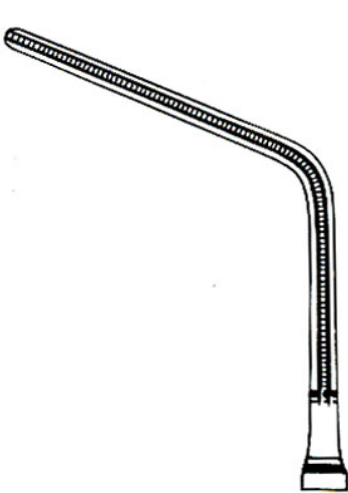

23,5 cm/9¼"
 RU 7660-20

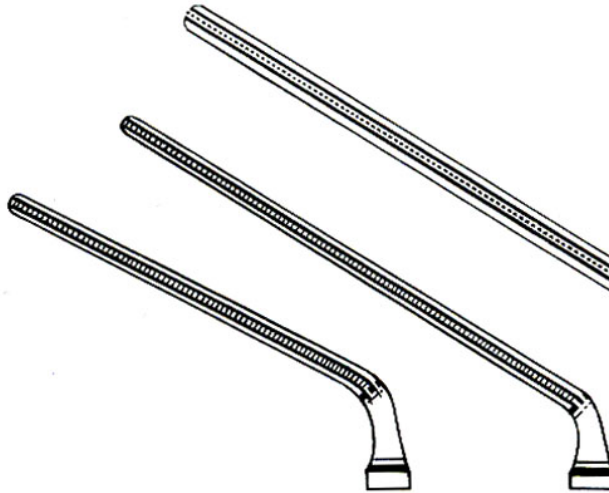

22 cm/8¾"
 RU 7661-22

24 cm/9½"
 RU 7661-24



30,5 cm/12"
 RU 7661-30

Mehrzweckklemmen
 Multi purpose clamps
 Pinzas-clamps para
 usos varios
 Pinces-clamps à usage
 multiple
 Pinze per vari usi



De Bakey

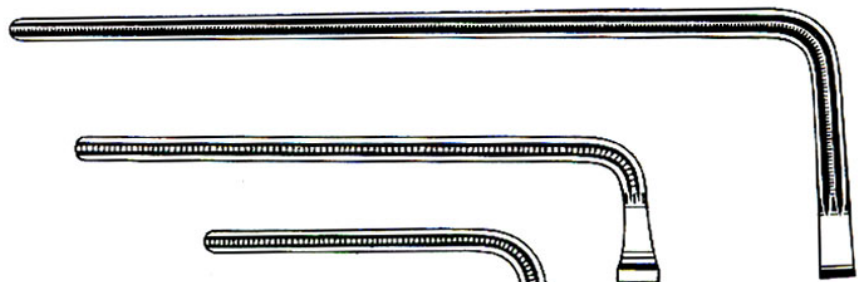

23 cm/9"
 RU 7662-23

27,5 cm/11"
 RU 7662-27

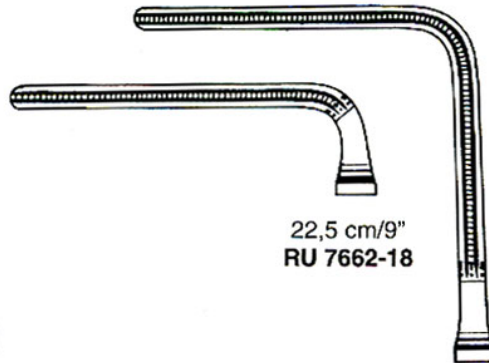

22,5 cm/9"
 RU 7662-18

19 cm/7½"
 RU 7662-19



Atrauma Cardiovascular-Klemmen
Atrauma Cardiovascular Forceps
Atrauma Pinzas-clamps cardiovasculares
Pinces vasculaires atraumatiques
Pinze cardiovascolari Atraumatiche

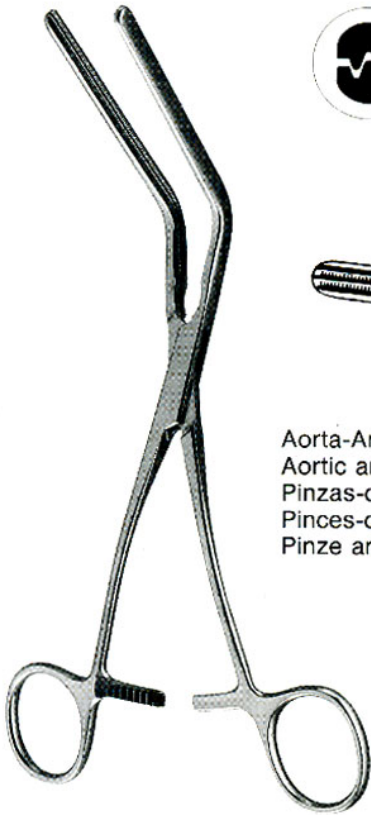
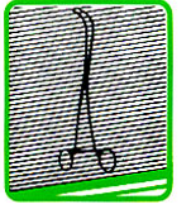

Morris-De Bakey



De Bakey

Aorta-Anastomosenklemmen
Aortic anastomosis clamps
Pinzas-clamps para anastomosis
Pinces-clamps pour l'anastomose de l'aorte
Pinze anastomosi aorta

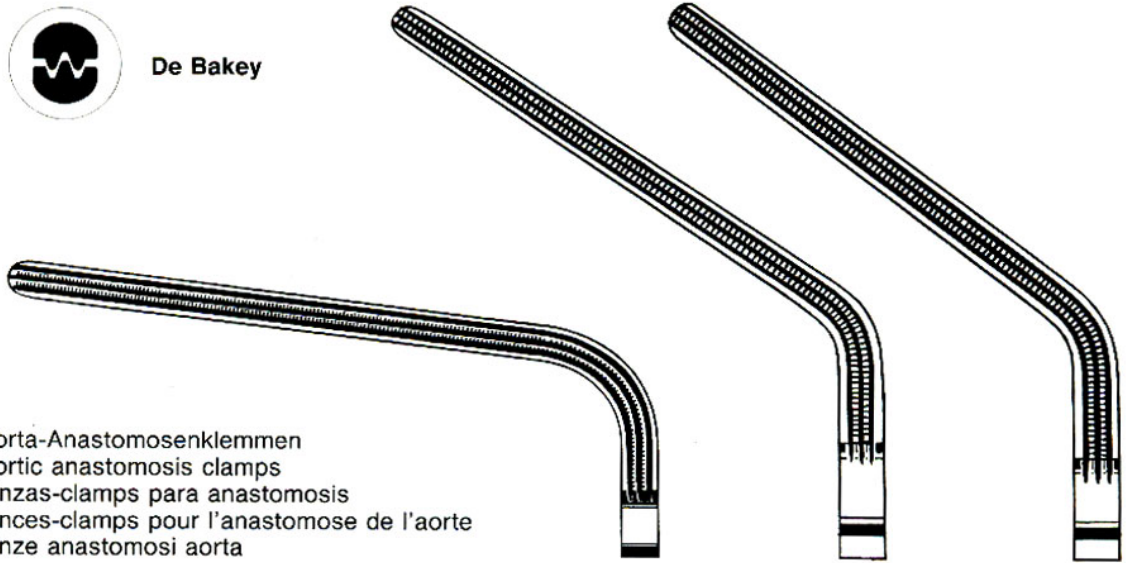

26 cm/10¼"
RU 7664-23

26,5 cm/10½"
RU 7664-25

20 cm/8"
RU 7664-20

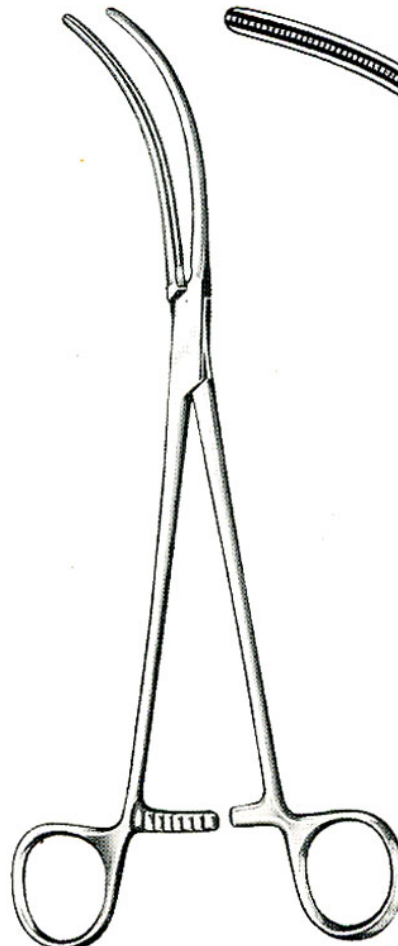

Glover
24,5 cm/9¾"
RU 7665-24



De Bakey

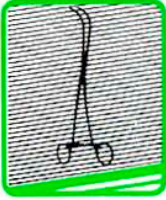

Atrauma Cardiovascular-Klemmen
Atrauma Cardiovascular Forceps
Atrauma Pinzas-clamps cardiovasculares
Pinces vasculaires atraumatiques
Pinze cardiovascolari Atraumatiche



De Bakey

Aorta-Aneurysmenklemmen
 Aorta aneurysm clamps
 Pinzas-clamps para aneurisma de aorta
 Pinces-clamps pour l'anévrisme de l'aorte
 Pinze per aneurisma dell' aorta



De Bakey-Bahnsen

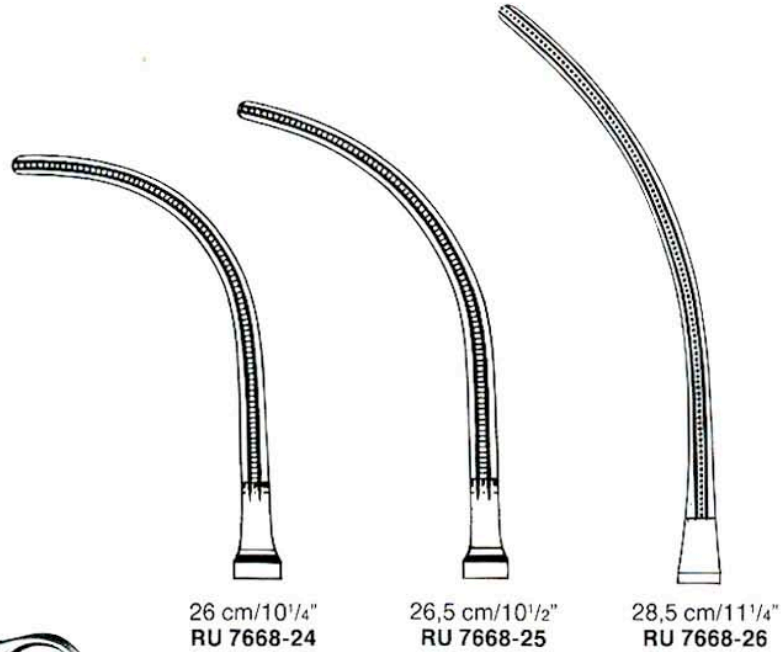

26 cm/10¹/₄"
 RU 7668-24

26,5 cm/10¹/₂"
 RU 7668-25

28,5 cm/11¹/₄"
 RU 7668-26

Coarctations-Klemmen
 Coarctation clamps
 Pinzas-clamps para coarctación
 Pinces-clamps pour la coarctation
 Pinze per coartazione

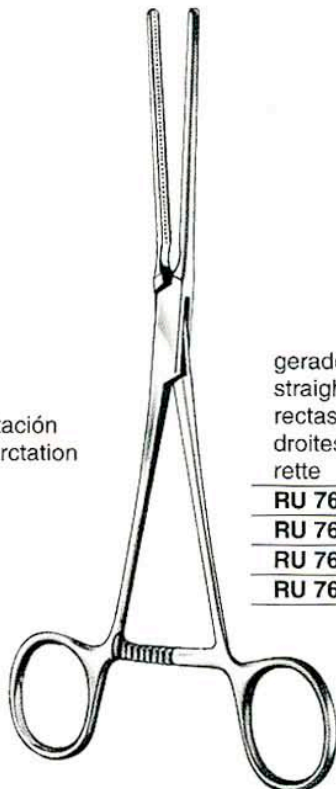

gerade
 straight
 rectas
 droites
 rette

gebogen
 curved
 curvas
 courbes
 curve

RU 7670-21	20 cm/8"	19,5 cm/7 ³ / ₄ "	RU 7671-21
RU 7670-23	23 cm/9"	22,5 cm/8 ³ / ₄ "	RU 7671-23
RU 7670-27	26 cm/10 ¹ / ₄ "	25,5 cm/10 ¹ / ₄ "	RU 7671-27
RU 7670-31	31,5 cm/12 ¹ / ₂ "	31 cm/12 ¹ / ₄ "	RU 7671-31



Atrauma Cardiovascular-Klemmen
 Atrauma Cardiovascular Forceps
 Atrauma Pinzas-clamps cardiovasculares
 Pinces vasculaires atraumatiques
 Pinze cardiovascolari Atraumatiche

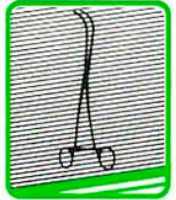

De Bakey

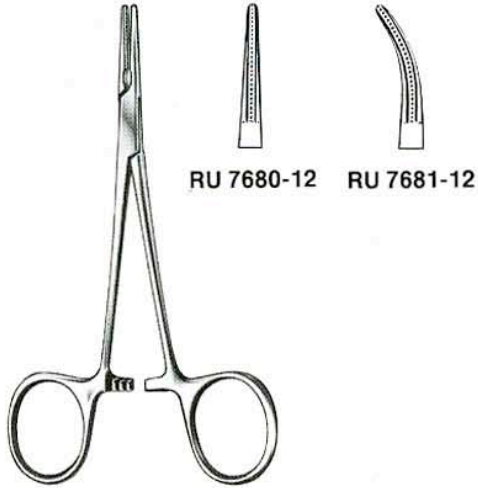

Mosquito
 12 cm/4³/₄"

Atrauma-Arterienklemmen
 Atrauma hemostatic forceps
 Pinzas hemostáticas atrauma
 Pinces hémostatiques atraumatiques
 Pinze emostatiche Atrauma

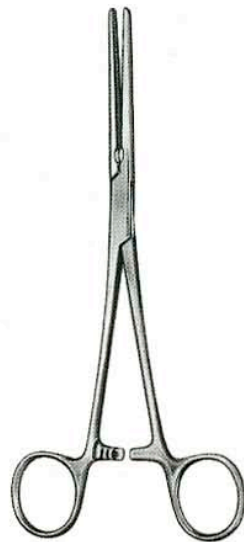

De Bakey-Pean

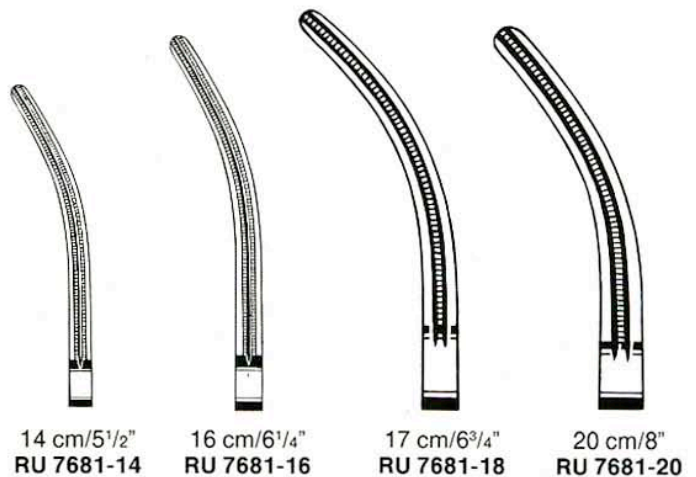
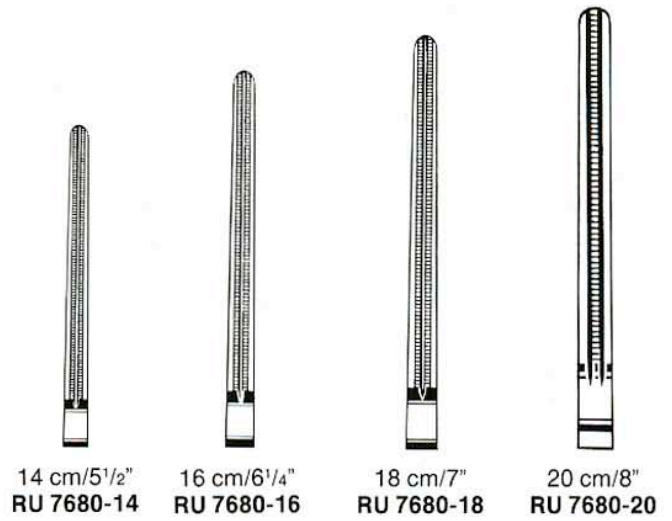

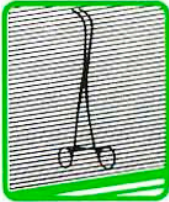

Atrauma Cardiovascular-Klemmen
Atrauma Cardiovascular Forceps
Atrauma Pinzas-clamps cardiovasculares
Pinces vasculaires atraumatiques
Pinze cardiovascolari Atraumatiche



De Bakey

Mehrzweckklemmen
 Multi purpose clamps
 Pinzas-clamps para usos varios
 Pinces-clamps à usage multiple
 Pinze per vari usi

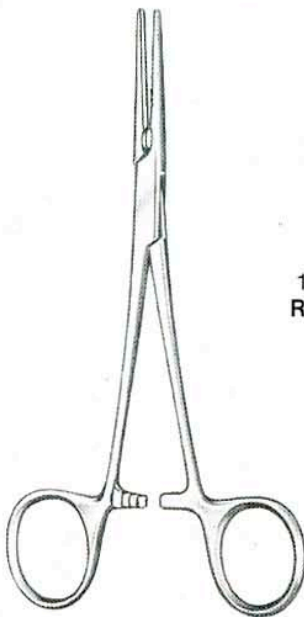

De Bakey-Rankin



16 cm/6¹/₄"
 RU 7682-16



16 cm/6¹/₄"
 RU 7683-16

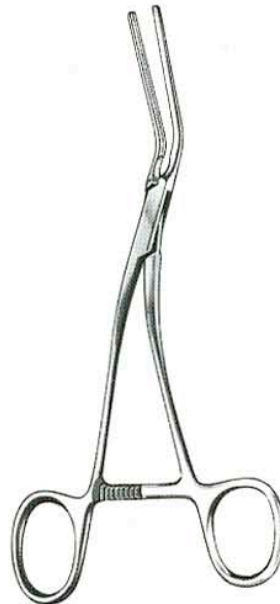

Cooley



16 cm/6¹/₄"
 RU 7685-16

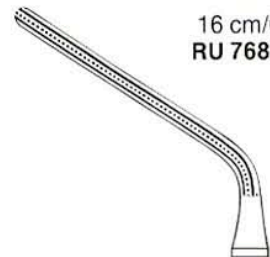

15,5 cm/6"
 RU 7686-15



14,5 cm/5³/₄"
 RU 7687-15

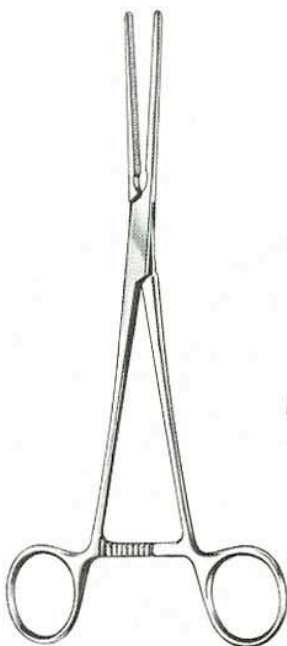

De Bakey
 17 cm/6³/₄"
 RU 7688-17

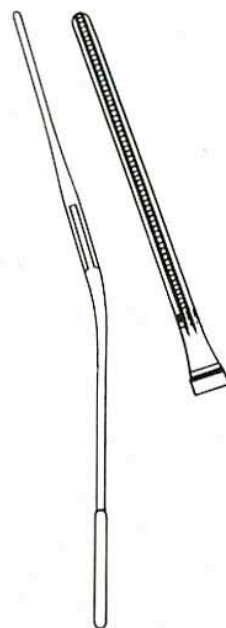
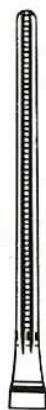

RU 7689-17



RU 7690-17



RU 7691-17



Atrauma Cardiovascular-Klemmen
Atrauma Cardiovascular Forceps
Atrauma Pinzas-clamps cardiovasculares
Pincas vasculaires atraumatiques
Pinze cardiovascolari Atraumatiche

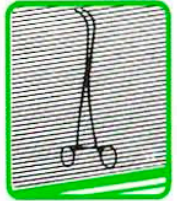

De Bakey

Anastomosenklemmen
 Anastomosis clamps
 Pinzas-clamps para anastomosis
 Pincas-clamps pour l'anastomose
 Pinze per anastomosi

Ligaturklemmen
 Ligature clamps
 Pinzas-clamps para ligadura
 Pincas-clamps pour la ligature
 Pinze per legature

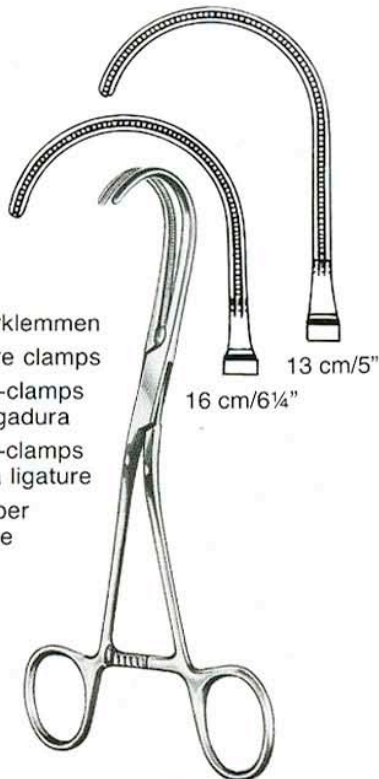

16 cm/6¼" RU 7692-16
 13 cm/5" RU 7692-17



Derra-De Bakey
 17 cm/6¾"

RU 7694-01

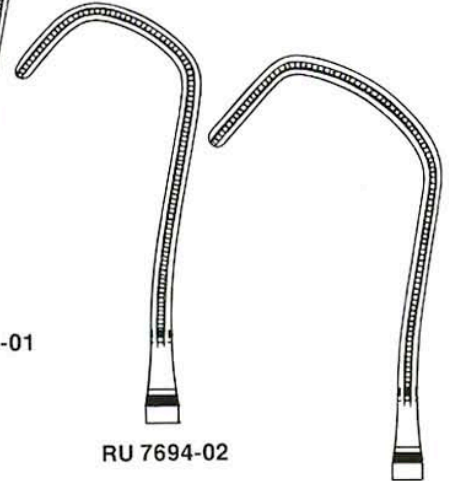

RU 7694-02

RU 7694-03

Profundaklemmen
 Profunda clamps
 Pinzas-clamps profundales
 Pincas-clamps profundales
 Pinze profunde

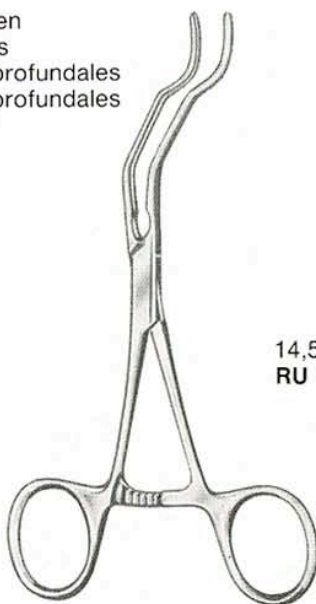

Gregory

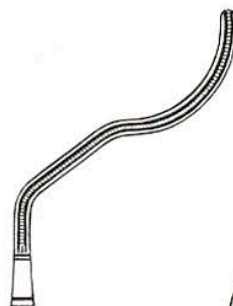

14,5 cm/5½"
 RU 7698-14

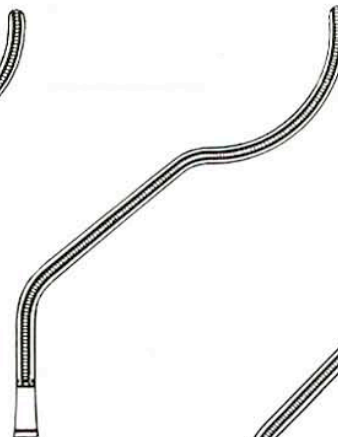

18,5 cm/7¼"
 RU 7698-16

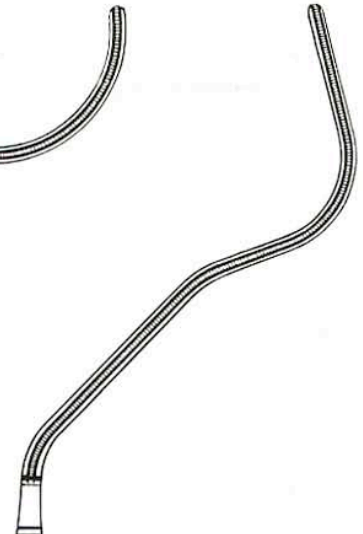

19,5 cm/7¾"
 RU 7698-18

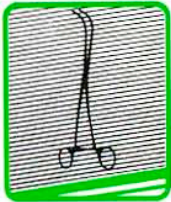

Atrauma Cardiovascular-Klemmen
Atrauma Cardiovascular Forceps
Atrauma Pinzas-clamps cardiovasculares
Pinces vasculaires atraumatiques
Pinze cardiovascolari Atraumatiche



De Bakey

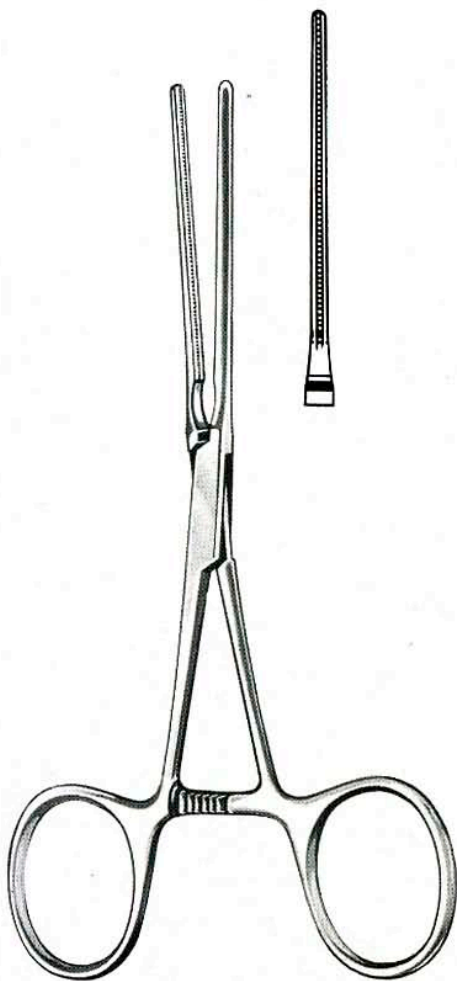

De Bakey
13 cm/5"
RU 7701-12

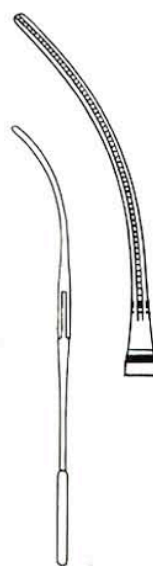

12,5 cm/5"
RU 7702-11

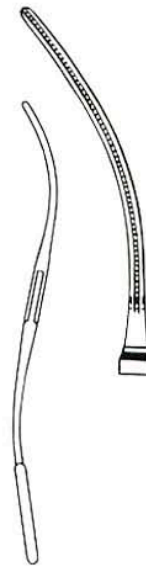

13 cm/5"
RU 7703-12

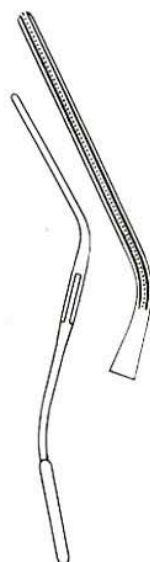

12,5 cm/5"
RU 7704-13

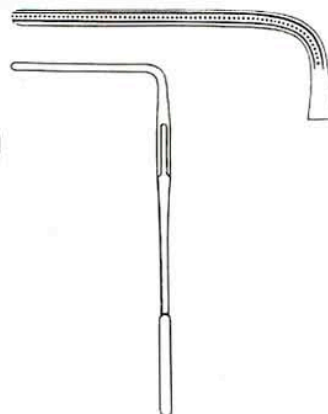

10 cm/4"
RU 7705-10



Atrauma Cardiovascular-Klemmen
Atrauma Cardiovascular Forceps
Atrauma Pinzas-clamps cardiovasculares
Pinces vasculaires atraumatiques
Pinze cardiovascolari Atraumatiche

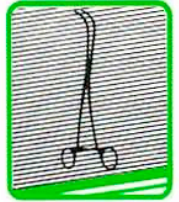

Karotisklemmen
 Carotid clamps
 Pinzas-clamps
 para carotis
 Pinces-clamps
 pour la carotide
 Pinze per la
 carotide

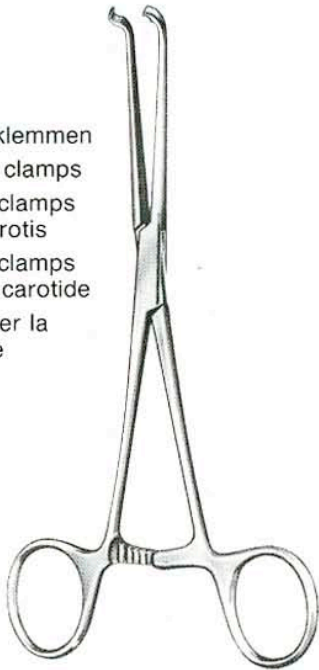

Javid
 15,5 cm/6"
 RU 7710-18

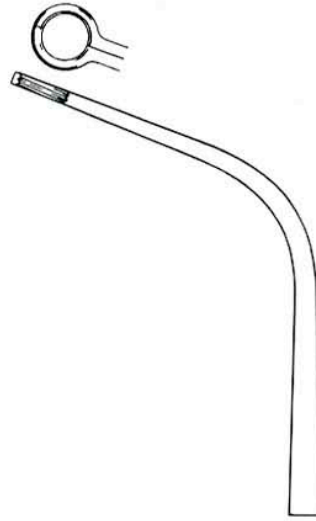

Javid
 18 cm/7"
 RU 7710-19



Cooley

Charrière (French)	Länge length largo longueur lunghezza cm	
24	16	RU 7711-24
26	16	RU 7711-26
28	19	RU 7711-28
30	19	RU 7711-30
32	19	RU 7711-32
36	19	RU 7711-36

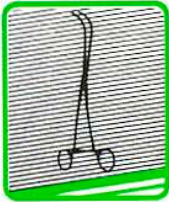

Atrauma Cardiovascular-Klemmen
 Atrauma Cardiovascular Forceps
 Atrauma Pinzas-clamps cardiovasculares
 Pincés vasculaires atraumatiques
 Pinze cardiovascolari Atraumatiche



Cooley

Coarctationsklemmen
 Coarctation clamps
 Pinzas-clamps para coartación
 Pincés-clamps pour la coarctation
 Pinze per coartazione

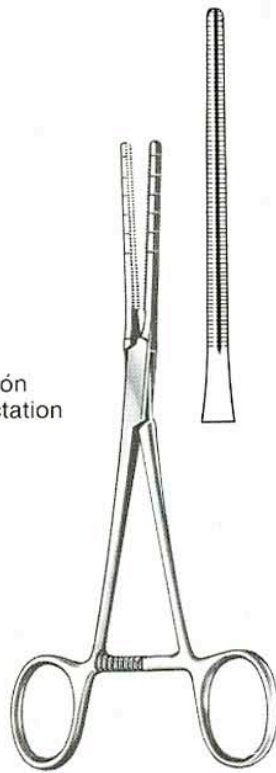

Cooley
 17 cm/6³/₄"
 RU 7721-17

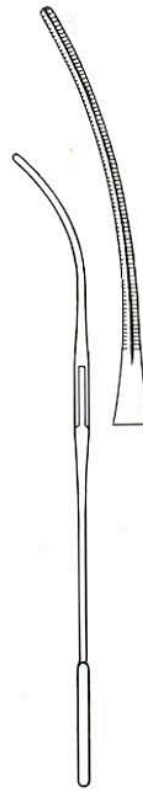

17 cm/6³/₄"
 RU 7722-17

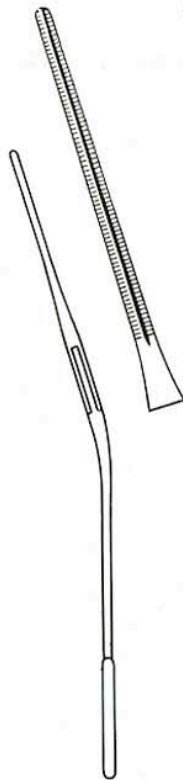

17 cm/6³/₄"
 RU 7723-17



17,5 cm/7"
 RU 7724-17



Atrauma Cardiovascular-Klemmen
Atrauma Cardiovascular Forceps
Atrauma Pinzas-clamps cardiovasculares
Pincers vasculaires atraumatiques
Pinze cardiovascolari Atraumatiche

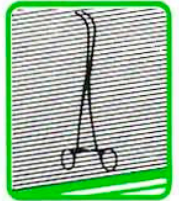

Cooley

Mehrzweckklemmen
Multi purpose clamps
Pinzas-clamps para usos varios
Pincers-clamps à usage multiple
Pinze per vari usi

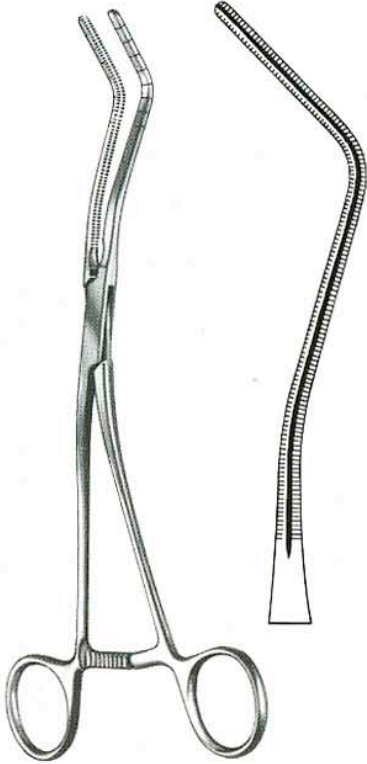

Cooley
20 cm/8"
RU 7726-20



16,5 cm/6 1/2"
RU 7728-17

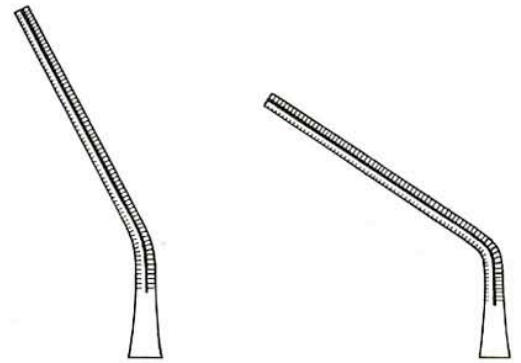

15,5 cm/6"
RU 7729-15



13,5 cm/5 1/4"
RU 7730-15

Cooley

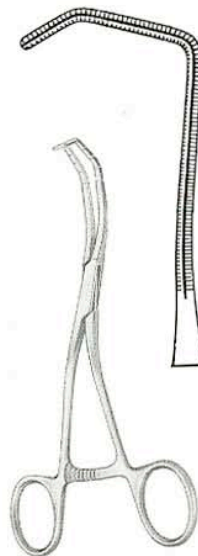

Cooley
16 cm/6 1/4"
RU 7734-17

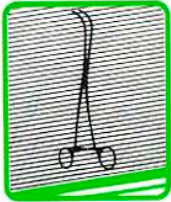

Atrauma Cardiovascular-Klemmen
Atrauma Cardiovascular Forceps
Atrauma Pinzas-clamps cardiovasculares
Pinces vasculaires atraumatiques
Pinze cardiovascolari Atraumatiche



Anastomosenklemmen
 Anastomosis clamps
 Pinzas-clamps para anastomosis
 Pinces-clamps pour l'anastomose de l'aorte
 Pinze per anastomosi



Cooley



RU 7735-16

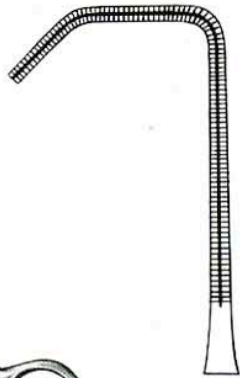

RU 7736-16

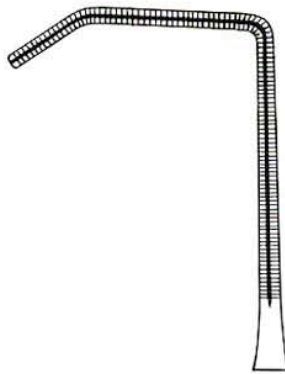

RU 7737-17

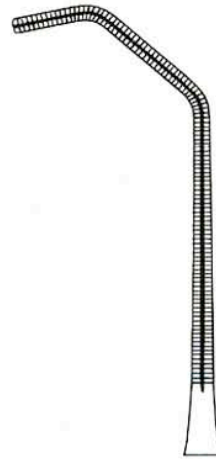

RU 7738-17

Cooley

16,5 cm/6¹/₂"

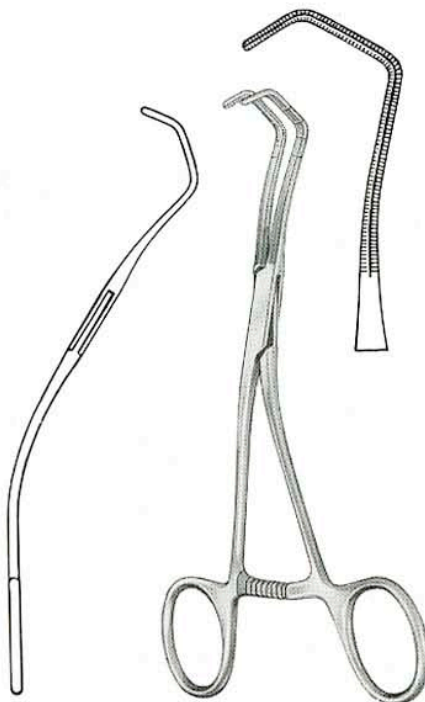

Cooley
 16 cm/6¹/₄"
 RU 7740-16



Beck
 17 cm/6³/₄"
 RU 7741-17



Atrauma Cardiovascular-Klemmen
Atrauma Cardiovascular Forceps
Atrauma Pinzas-clamps cardiovasculares
Pinces vasculaires atraumatiques
Pinze cardiovascolari Atraumatiche

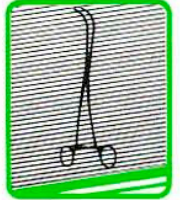

Cooley



Cooley-Derra

Ligaturklemmen
Ligature clamps
Pinzas-clamps para ligadura
Pinces-clamps pour la ligature
Pinze per legature



Cooley

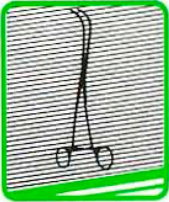

Atrauma Kinderklemmen
Atrauma Pediatric Clamps
Atrauma Pinzas-clamps pediatricos
Pinces-clamps atraumatiques pour la pédiatrie
Pinze cardiovascolari Atraumatiche per bambini



Cooley

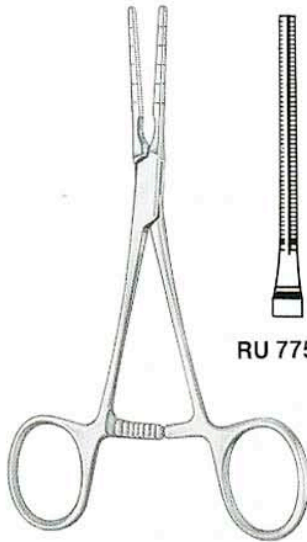

RU 7754-01

Cooley
14 cm/5 1/2"



RU 7754-02

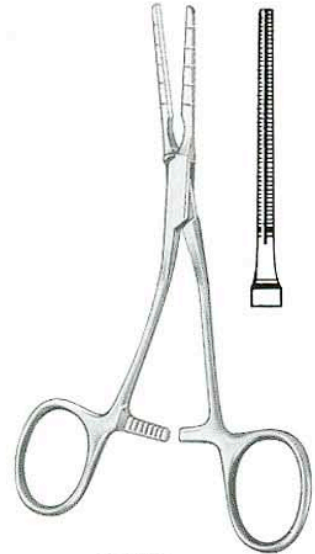

Cooley
14 cm/5 1/2"
RU 7754-03

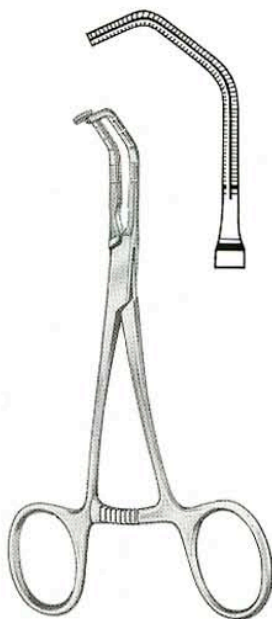

Cooley
14 cm/5 1/2"
RU 7754-04



Cooley
14 cm/5 1/2"
RU 7754-05



Neonatal- und Kinderklemmen
Neonatal and Pediatric Clamps
Pinzas-clamps pediaticos y para recién-nacidos
Pinces-clamps néonatales et pédiatriques
Pinze per neonati e bambini

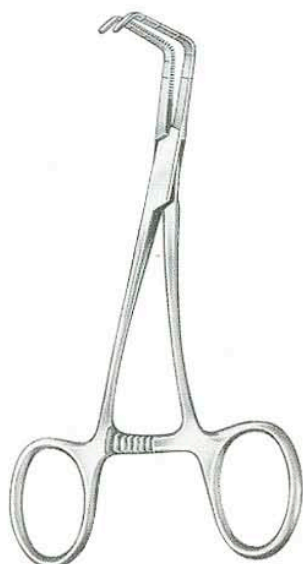
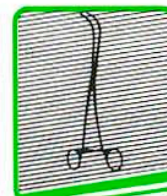

ca. 15 cm

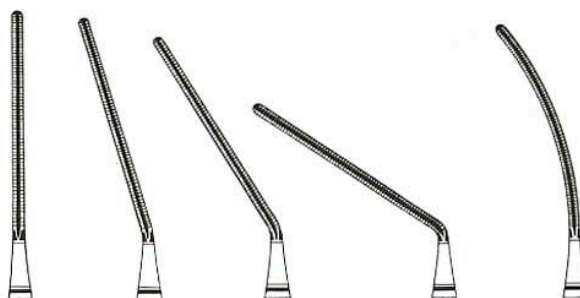

Fig. 1 2 3 4 5



Fig. 6 7 8 9

Fig.	gerade straight rectas droites rette
1	RU 7755-01
2	RU 7755-02
3	RU 7755-03
4	RU 7755-04
5	RU 7755-05
6	RU 7755-06
7	RU 7755-07
8	RU 7755-08
9	RU 7755-09



Fig.	abgewinkelt angled acodadas coudées angolari
1	RU 7756-01
2	RU 7756-02
3	RU 7756-03
4	RU 7756-04
5	RU 7756-05
6	RU 7756-06
7	RU 7756-07
8	RU 7756-08
9	RU 7756-09

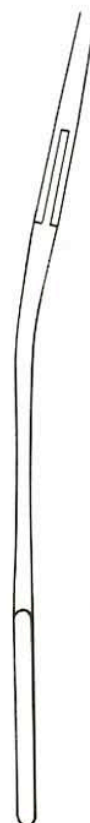
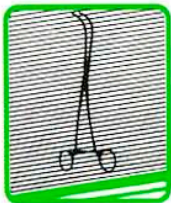
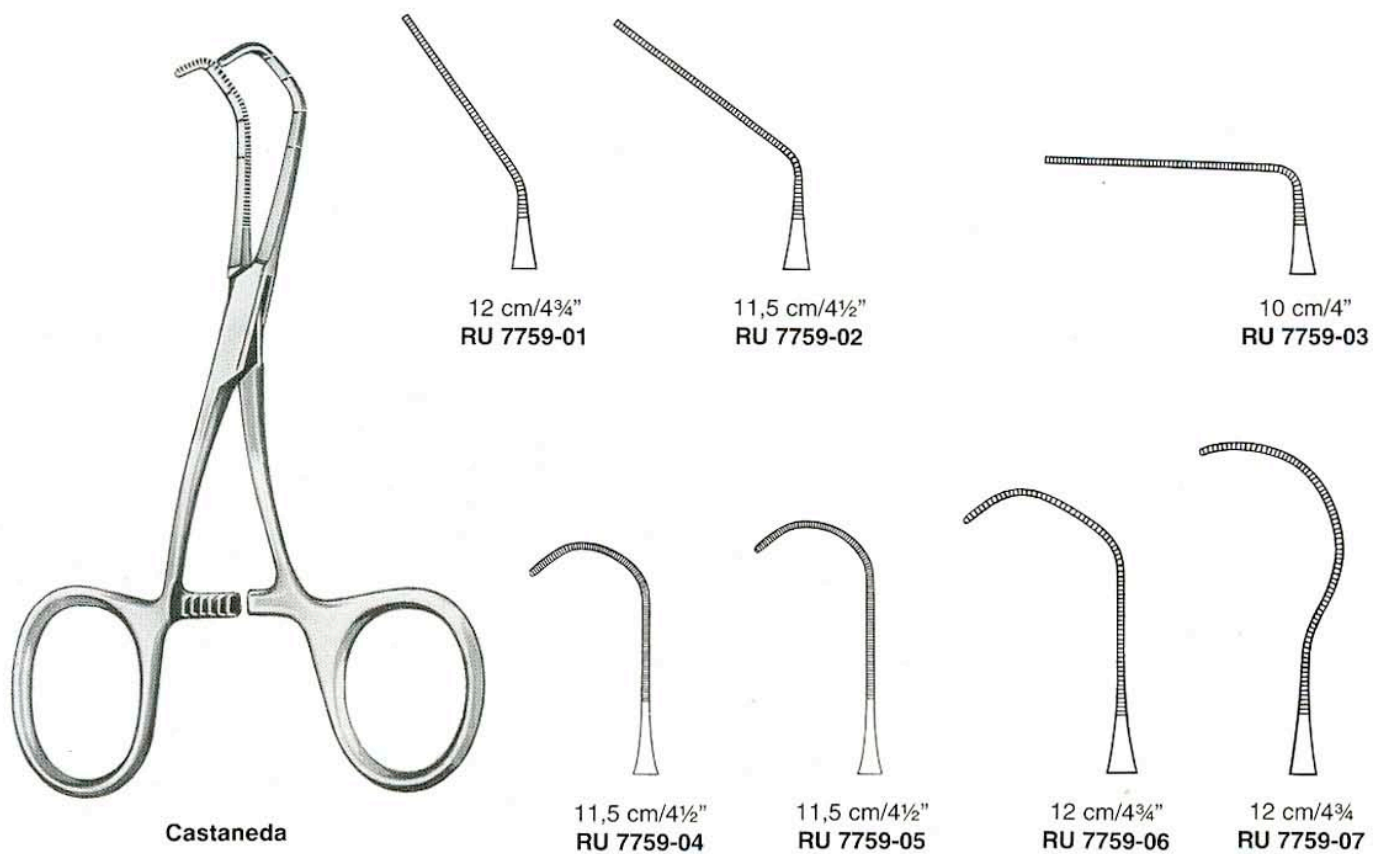

Fig.	gebogen curved curvas courbes curve
1	RU 7757-01
2	RU 7757-02
3	RU 7757-03
4	RU 7757-04
5	RU 7757-05
6	RU 7757-06
7	RU 7757-07
8	RU 7757-08
9	RU 7757-09





Neonatal-Klemmen
Neonatal Clamps
Pinzas-clamps para recién nacidos
Pinces-clamps néonatales
Pinze per neonati





Aorta Dilatatore
Aortic Dilators
Dilatadores de aorta
Dilatateurs aortiques
Dilatatori vascolari

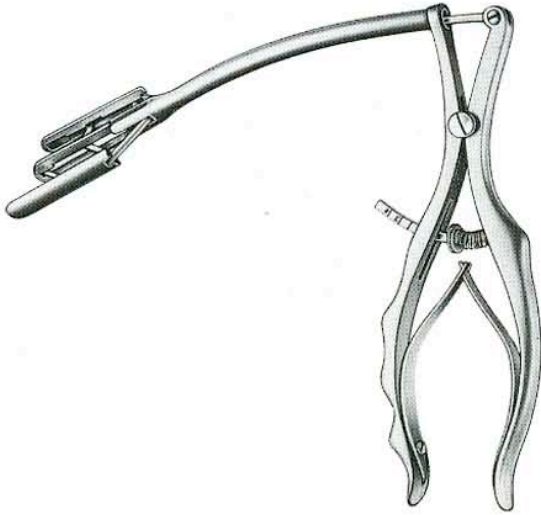
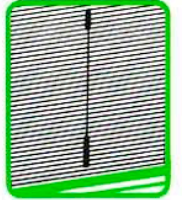

Cooley
RU 7761-00



Gerbode
RU 7762-00



Tubbs
RU 7763-00

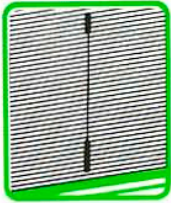

Gefäß-Dilatatoren
Vascular Dilators
Dilatadores vasculares
Dilatateurs vasculaires
Dilatatori vascolari



De Bakey

mm Ø	19 cm/7 1/2"	35 cm/14"
0,5	RU 7770-05	RU 7771-05
1,0	RU 7770-10	RU 7771-10
1,5	RU 7770-15	RU 7771-15
2,0	RU 7770-20	RU 7771-20
2,5	RU 7770-25	RU 7771-25
3,0	RU 7770-30	RU 7771-30
3,5	RU 7770-35	RU 7771-35
4,0	RU 7770-40	RU 7771-40
4,5	RU 7770-45	RU 7771-45
5,0	RU 7770-50	RU 7771-50
7,0	RU 7770-70	RU 7771-70
9,0	RU 7770-90	RU 7771-90

biegsam
 malleable
 malleables
 souples
 malleabili



Cooley
 13 cm/5"

0,5 mm Ø RU 7772-05	1,0 mm Ø RU 7772-10	1,5 mm Ø RU 7772-15	2,0 mm Ø RU 7772-20	2,5 mm Ø RU 7772-25	3,0 mm Ø RU 7772-30	4,0 mm Ø RU 7772-40	5,0 mm Ø RU 7772-50



Saugrohre, Tourniquets
 Suction Tubes, Tourniquets
 Cánulas de aspiración, Torniquetes
 Canules d'aspiration, Tourniquets
 Tubi d'aspirazione, Tornichetti

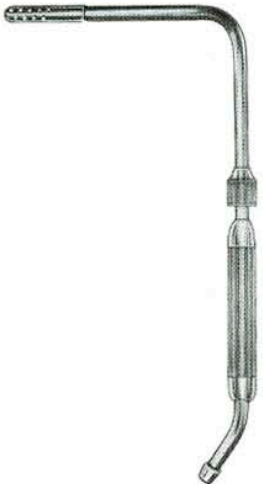
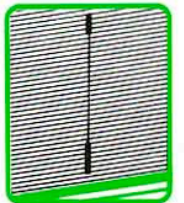

Cooley
 25 cm/10"
 RU 7780-01



Cooley
 33 cm/13"
 RU 7780-02



Cooley
 30 cm/12"
 RU 7780-03



Cooley
 30 cm/12"
 RU 7780-04



Cooley
 35 cm/13³/₄"
 RU 7780-05

Tourniquets
 Tourniquets
 Torniquetes
 Tourniquets
 Tornichetti



Rumel-Belmont
 3,2 mm Ø **RU 7787-32**
 6,4 mm Ø **RU 7787-64**