

# RHINOLOGIE UND RHINOPLASTIK

## *RHINOLOGY AND RHINOPLASTY*

Seiten 243 - 318

*Pages 243- 318*

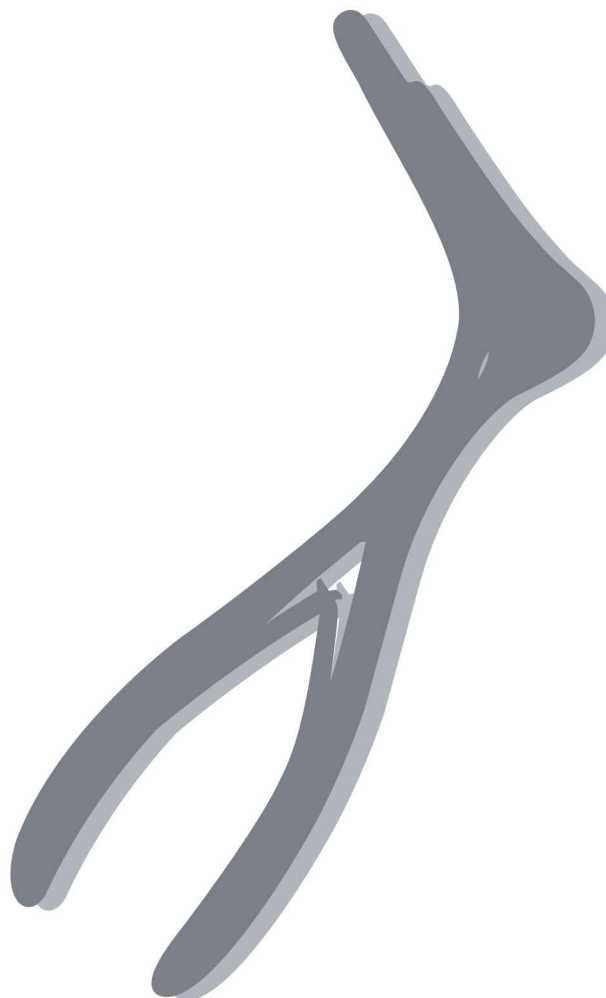

### Übersicht

Scheren, Klemmen, Pinzetten  
Spatel, Sonden, Stopfer, Watteträger  
Prüf- und Messinstrumente  
Nasenspekula, Zubehör  
Polypenschnürer  
Zerstäuber, Spiegel  
Zangen, Septumschere, Stanzen  
Messer, Elevatorien, Raspatorien  
Osteotome, Präparatoren, Meißel  
Hämmer, Sägen, Raspeln  
Knochen-Knorpelquetsche, Zubehör  
Haken, Krallen, Fadengabeln

### Overview

Scissors, sinus-, tissue forceps  
Spatulas, probes, tampers, cotton applicators  
Examination and measuring instruments  
Nasal specula, accessories  
Nasal snares  
Atomizers, mirrors  
Forceps, septum scissors, sphenoid forceps  
Knives, elevators, raspatories  
Osteotomes, dissectors, gouges, chisels  
Mallets, saws, rasps  
Bone crusher, accessories  
Hooks, retractors, pusher, knottiers

### Seiten / Pages

244-257, 276, 277  
258-259  
260  
261-272  
273  
274-276  
277-288, 317-318  
288-290, 291-295, 316  
296-302  
302-308  
308-309  
309-316

**PRÄPARIERSCHEREN  
DISSECTING SCISSORS**



**Baby-Metzenbaum**

gerade/straight 11,5 cm/4½" gebogen/curved  
**RU 1280-11** **RU 1281-11**



**Metzenbaum-Fino**

14,5 cm/5¾"  
gebogen/curved  
**RU 1291-14**



**Metzenbaum**

14,5 cm/5½"  
gerade/straight  
**RU 1301-14**

**Rudolf**<sup>®</sup>  
Tc

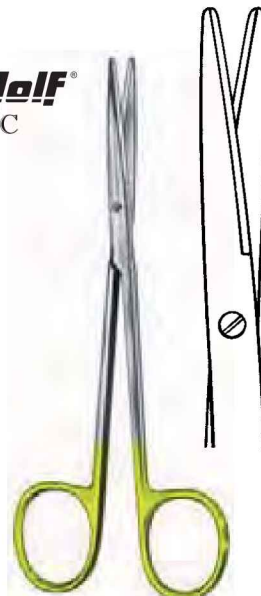

**Metzenbaum**

14,5 cm/5½"  
**RU 1304-14**

**PRÄPARIERSCHEREN  
DISSECTING SCISSORS**



**Metzenbaum**  
14,5 cm/5½"  
gebogen/curved  
**RU 1311-14**

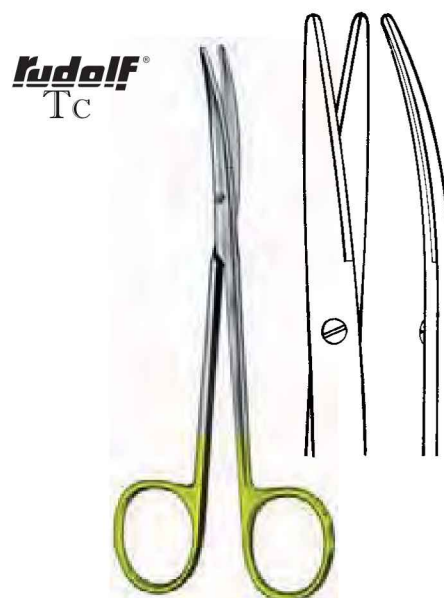

**Metzenbaum**  
14,5 cm/5½"  
gebogen/curved  
**RU 1314-14**



**Metzenbaum**  
18 cm/7"  
gebogen/curved  
**RU 1331-18**



**Metzenbaum**  
18 cm/7"  
gebogen/curved  
**RU 1334-18**

**FEINE SCHEREN**  
**FINE SCISSORS**

gerade  
straight



**Fig. 1**  
**RU 1521-12**



**Fig. 2**  
**RU 1522-12**



**Fig. 3**  
**RU 1523-12**



**Wagner**  
12 cm/4 3/4"

gebogen  
curved



**Fig. 1**  
**RU 1524-12**



**Fig. 2**  
**RU 1525-12**



**Fig. 3**  
**RU 1526-12**



**Jameson-Werber**  
13 cm/5"  
gebogen/curved  
**RU 1584-13**



**Jameson**  
15 cm/6"  
gebogen/curved  
**RU 1584-15**



9 cm/3 1/2"  
**RU 1636-09**



**Joseph**  
14 cm/5 1/2"  
gerade/straight  
**RU 1670-14**



gebogen/curved  
**RU 1671-14**



**Kilner (Ragnell)**  
12 cm/4 3/4" **RU 1675-12**  
13 cm/5" **RU 1675-13**  
15 cm/6" **RU 1675-15**

**NASENSCHEREN  
NASAL SCISSORS**



**Heymann**  
18 cm/7"  
**RU 2115-18**

**Rudolf**<sup>®</sup>  
SUPERCUT



**Heymann**  
18 cm/7"  
gezahnt/saw edge  
**RU 2115-18 MC**



**Heymann**  
19,5 cm/7<sup>3</sup>/<sub>4</sub>"  
**RU 2116-19**



**Kirstein**  
17,5 cm/7"  
gezahnt/saw edge  
**RU 2117-18**

**NASENSCHEREN  
NASAL SCISSORS**



**Cottle-Masing**  
10,5 cm/4 1/8"  
spitz/sharp      stumpf/blunt  
**RU 2120-10      RU 2121-10**



**Kilner**  
13,5 cm/5 1/4"  
**RU 2124-11**



**Fomon**  
13 cm/5"  
**RU 2130-13**



**Rudolf**<sup>®</sup>  
**SUPERCUT**  
**Fomon**  
13 cm/5"  
gezahnt/serrated  
**RU 2130-13 MC**



**Rudolf**<sup>®</sup>  
**SUPERCUT**  
**Fomon**  
13,5 cm/5 1/2"  
schlank/gezahnt  
delicate/serrated  
**RU 2131-13**



**Fomon**  
13 cm/5"  
extra schlank/delicate  
**RU 2131-13 MC**

**NASENSCHEREN  
NASAL SCISSORS**



**Fomon**  
13,5 cm/5¼"  
RU 2132-13

**Rudolf**<sup>®</sup>  
SUPERCUT



**Fomon**  
13 cm/5"  
RU 2132-13 MC



**Cottle**  
16 cm/6¼"  
RU 2135-16

**Rudolf**<sup>®</sup>  
SUPERCUT



**Cottle**  
16 cm/6¼"  
gezahnt/serrated  
RU 2135-16 MC



**Halle**  
19 cm/7½"  
RU 2140-19

**Rudolf**<sup>®</sup>  
Tc  
RU 2136-16

**FEINE SCHEREN**  
**FINE SCISSORS**

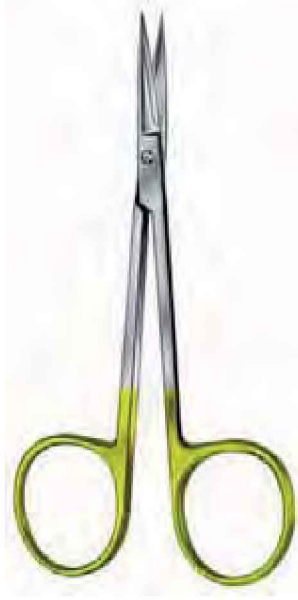

gerade/straight  
11,5 cm/4½"  
**RU 2406-11**

**Rudolf**<sup>®</sup>  
Tc



gebogen/curved  
11,5 cm/4½"  
**RU 2407-11**



**Fino**  
gerade/straight  
10,5 cm/4¼" **RU 2418-10**  
11,5 cm/4½" **RU 2418-11**



**Fino**  
gebogen/curved  
10,5 cm/4¼" **RU 2419-10**  
11,5 cm/4½" **RU 2419-11**



**FEINE SCHEREN**  
**FINE SCISSORS**



	gerade/straight	gebogen/curved	<b>Fino</b> gerade/straight	<b>Fino</b> gebogen/curved
9,5 cm/3¾"	<b>RU 2420-09</b>	<b>RU 2421-09</b>	<b>RU 2422-09</b>	<b>RU 2423-09</b>
10,5 cm/4¼"	<b>RU 2420-10</b>	<b>RU 2421-10</b>	<b>RU 2422-10</b>	<b>RU 2423-10</b>
11,5 cm/4½"	<b>RU 2420-11</b>	<b>RU 2421-11</b>	<b>RU 2422-11</b>	<b>RU 2423-11</b>



**Stevens**  
10,5 cm/4¼"  
11,5 cm/4½"  
Sehnenscheren  
Tenotomy scissors



gerade, spitz  
straight, pointed

**RU 2430-10**  
**RU 2430-11**

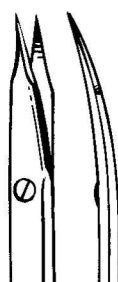

gebogen, spitz  
curved, pointed

**RU 2431-10**  
**RU 2431-11**



gerade, stumpf  
straight, blunt

**RU 2440-10**  
**RU 2440-11**



gebogen, stumpf  
curved, blunt

**RU 2441-10**  
**RU 2441-11**

**FEINE SCHEREN**  
**FINE SCISSORS**



**Graefe**  
10,5 cm/4¼"  
**RU 2455-10**



11,5 cm/4½"  
gerade/straight **RU 2460-11**  
gebogen/curved **RU 2461-11**



**Rudolf**  
Tc  
gerade/straight  
11,5 cm/4½"  
**RU 2462-11**



gebogen/curved  
**RU 2463-11**



**Chadwick**  
11 cm/4½"  
**RU 2470-11**



9,5 cm/3¾"  
gerade/straight **RU 2476-02**  
gebogen/curved **RU 2476-03**

**ARTERIENKLEMMEN  
ARTERY FORCEPS**



14 cm/5½"  
gerade/straight **RU 3068-14**  
gebogen/curved **RU 3069-14**



**Crile**  
14 cm/5½"



**RU 3070-14**

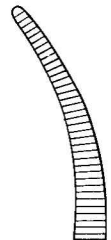

**RU 3071-14**



**Providence**  
14 cm/5½"



**RU 3090-14**



**RU 3091-14**



**Halsted-Mosquito**  
12 cm/4¾"



**RU 3100-12**



**RU 3101-12**



**RU 3110-12**



**RU 3111-12**

**SINUSKLEMMEN**  
**SINUS FORCEPS**

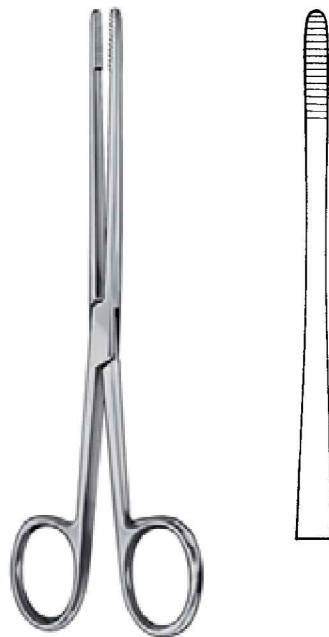

**Lister**

12,5 cm/5"  
16 cm/6"  
18 cm/7"

**RU 3810-12**  
**RU 3810-16**  
**RU 3810-18**

**ANATOMISCHE UND CHIRURGISCHE PINZETTEN**  
**DRESSING AND TISSUE FORCEPS**



**Cottle**  
15 cm/6"  
**RU 4026-15**



**Adson  
Standard**



**Adson**



**Rudolf**<sup>®</sup>  
Tc

12 cm/4¾"	<b>RU 4035-12</b>	<b>RU 4036-12</b>
15 cm/6"	<b>RU 4035-15</b>	<b>RU 4036-15</b>

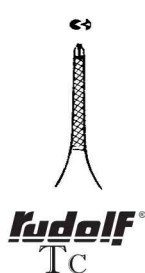

1:2



**Adson  
Standard**

cm/in

**Micro-Adson**

12/4¾	<b>RU 4130-12</b>	<b>RU 4130-00/12</b>	<b>RU 4135-12</b>
15/6	<b>RU 4130-15</b>	<b>RU 4130-00/15</b>	<b>RU 4135-15</b>

**FEINE PINZETTEN, ATRAUMATISCHE PINZETTEN**  
**FINE FORCEPS, ATRAUMATIC FORCEPS**

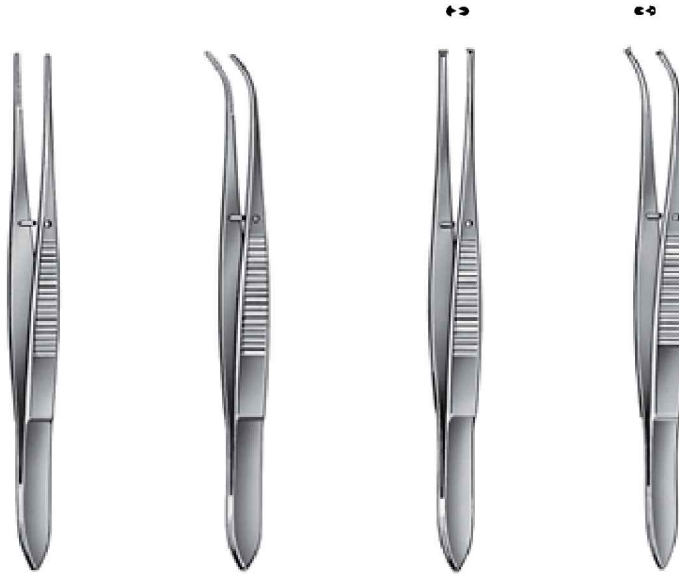

10,5 cm/4<sup>3</sup>/<sub>4</sub>"

**RU 4250-10**

**RU 4251-10**

**RU 4260-10**

**RU 4261-10**



1,5 mm

**De Bakey**

16 cm/6<sup>1</sup>/<sub>4</sub>"

**RU 7580-16**



**Adson-Atrauma**

**RU 7585-12**

12 cm/4<sup>3</sup>/<sub>4</sub>"

**RU 7585-15**

15 cm/6"

**NASENPINZETTEN, FASSPINZETTEN  
NASAL FORCEPS, GRASPING FORCEPS**



**Cottle**  
15 cm/6"  
**RU 7863-15**

2,2 mm



**Jansen  
(Gruenwald)**

1 mm



**Jansen  
(Fine)**

16 cm/6¼"	<b>RU 7864-16</b>	<b>RU 7864-16/1</b>
18 cm/7"	<b>RU 7864-18</b>	<b>RU 7864-18/1</b>
20 cm/8"	<b>RU 7864-20</b>	<b>RU 7864-20/1</b>



**Cottle**  
10 cm/4"  
**RU 8312-10**



**Graefe**  
11 cm/4½"

ohne Schloß  
*without spring catch*  
**RU 9942-11**

mit Schloß  
*with spring catch*  
**RU 9943-11**



**Castroviejo**  
10 cm/4"  
**RU 9964-05**

Zahnbreite  
*Width of teeth*  
0,5 mm

**ÄTZSPATEL, NASENSONDEN, STOPFER  
CAUSTIC SPATULA, NASAL-PROBES, TAMPER**



**Lange**  
18 cm/7"  
**RU 4919-01**



**Killian**  
16,5 cm/6½"  
Ø 1,5 mm  
**RU 4927-01**



16 cm/6¼"  
Ø 1,4 mm  
**RU 4927-02**



**Siebenmann**  
18 cm/7"  
**RU 4928-18**



**WATTETRÄGER  
COTTON APPLICATORS**



**Universal**

cm	in	Ø 1,2 mm	Ø 1,5 mm	Ø 1,7 mm
12,5	5	<b>RU 4930-12</b>		<b>RU 4932-12</b>
16	6¼	<b>RU 4930-16</b>		<b>RU 4932-16</b>
18	7		<b>RU 4931-18</b>	<b>RU 4932-18</b>



spiralförmig  
spiral threads

**Frohn**

Ø 1,0 mm

12 cm/4¾" **RU 4934-01**  
14 cm/5½" **RU 4934-02**  
16 cm/6¼" **RU 4934-03**



**Frohn**

Ø 1,0 mm

12 cm/4¾" **RU 4934-11**  
14 cm/5½" **RU 4934-12**  
16 cm/6¼" **RU 4934-13**

**PRÜF- UND MESSINSTRUMENTE**  
**EXAMINATION AND MEASURING INSTRUMENTS**



graduiert mm: in  
graduated mm: in  
10 cm/4" **RU 5104-10**  
15 cm/6" **RU 5104-15**  
20 cm/8" **RU 5104-20**



**Townley**  
10 cm/4"  
**RU 5114-10**

**NASENSPEKULA  
NASAL SPECULA**



**RU 8000-01**

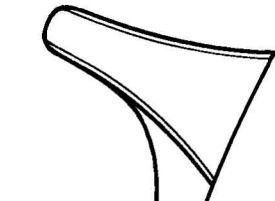
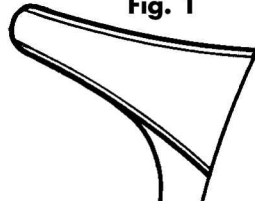

**Fig. 1**

**RU 8000-01 AS**



**RU 8000-02**



**Fig. 2**

**RU 8000-02 AS**

**RU 8000-03**

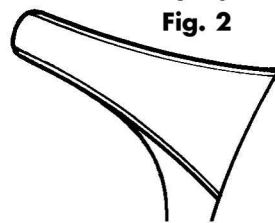

**Fig. 3**

**RU 8000-03 AS**

**Hartmann**  
15 cm/6"

**Hartmann**  
15 cm/6"



**RU 8002-00**

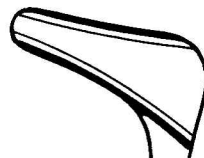

**Fig. 00**  
*Kinder/children*

**RU 8002-00 AS**

**RU 8002-01**

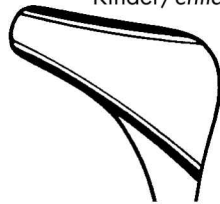

**Fig. 1**

**RU 8002-01 AS**

**RU 8002-02**

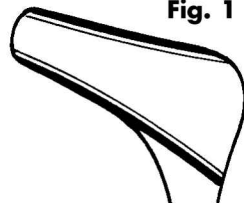

**Fig. 2**

**RU 8002-02 AS**

**RU 8002-03**

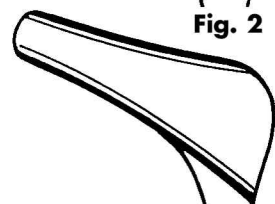

**Fig. 3**

**RU 8002-03 AS**

**Hartmann-Halle**  
15 cm/6"

**Hartmann-Halle**  
15 cm/6"

**NASENSPEKULA  
NASAL SPECULA**



**Tieck**  
13 cm/5"

**RU 8004-01**

**Fig. 1**

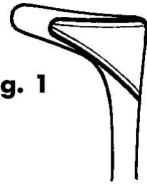

Säuglinge/  
infants

**RU 8004-01 AS**

**RU 8004-02**

**Fig. 2**

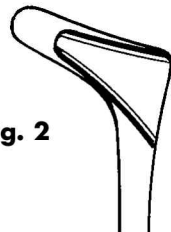

Kinder/  
children

**RU 8004-02 AS**



**Tieck**  
13 cm/5"



**Beckmann**  
15 cm/6"  
13 cm/5"

**Fig. 00  
RU 8005-00**

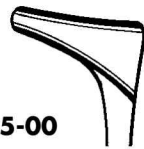

Säuglinge/  
infants

**Fig. 1  
RU 8005-01**

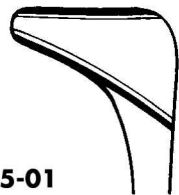

**Fig. 2  
RU 8005-02**

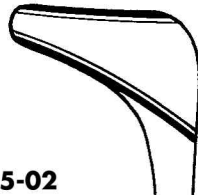

**Fig. 3  
RU 8005-03**



Säuglinge/  
infants

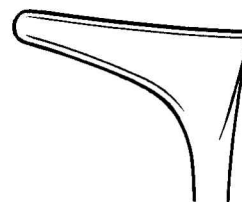

**Hartmann**  
14,5 cm/5¾"  
leichtes Modell  
light pattern  
**RU 8009-00**

**NASENSPEKULA  
NASAL SPECULA**



**Mod. Wien**  
13 cm/5"

**RU 8010-01**

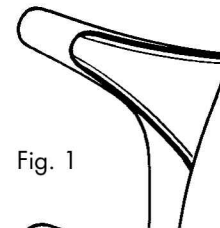

Fig. 1

**RU 8010-02**

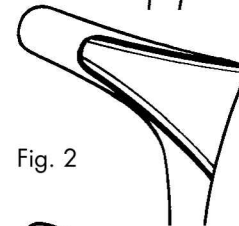

Fig. 2

**RU 8010-03**

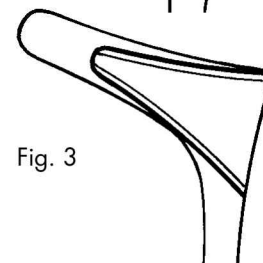

Fig. 3



**Mod. Wien**  
13 cm/5"

**RU 8011-01 AS**

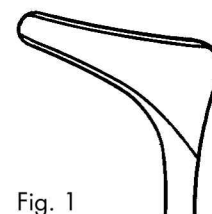

Fig. 1

**RU 8011-02 AS**

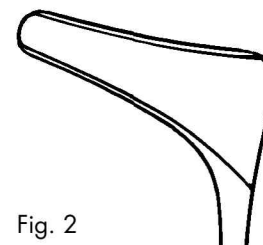
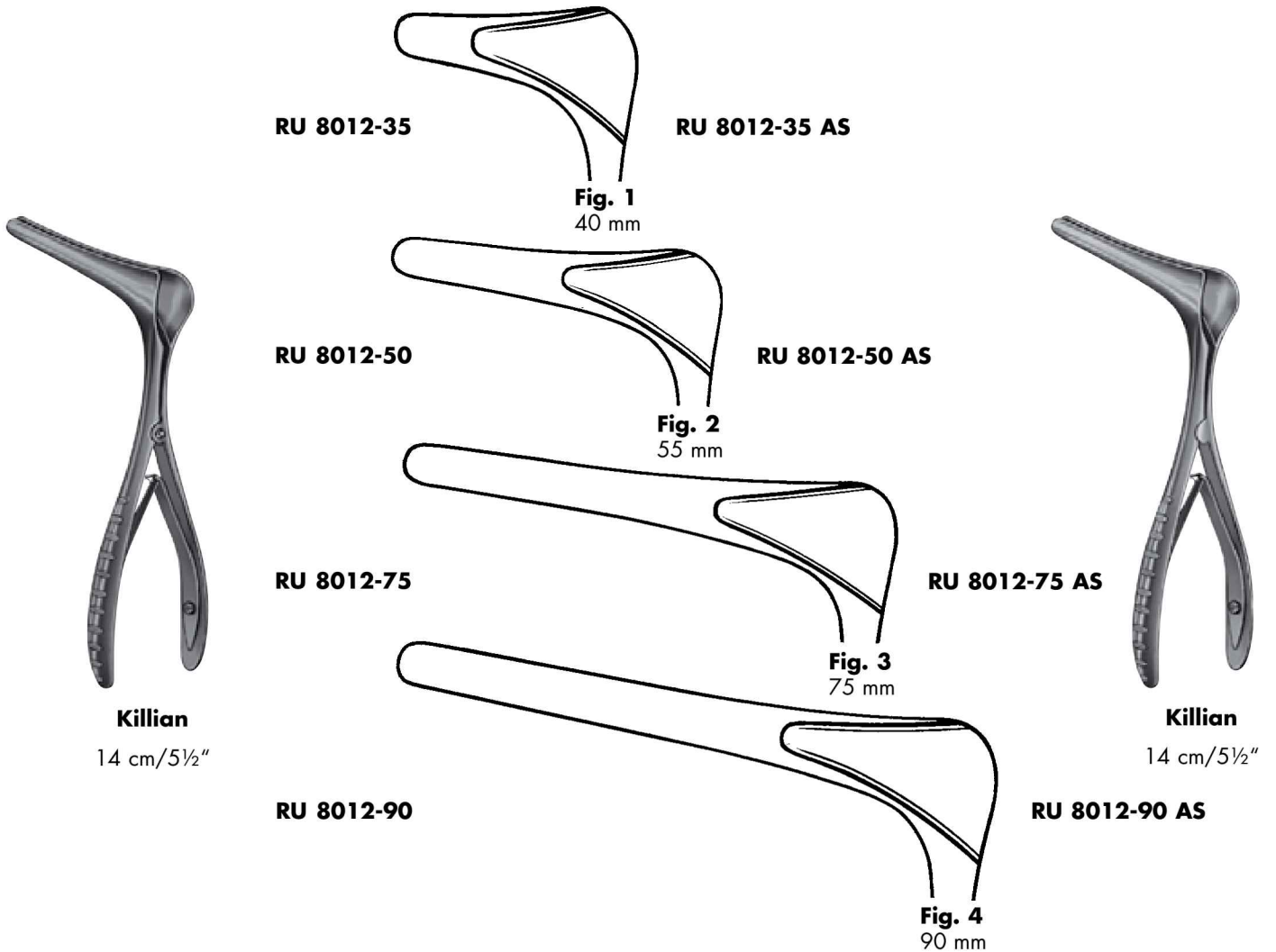

Fig. 2

**NASENSPEKULA  
NASAL SPECULA**



**Killian**  
14 cm/5½"

mit Kaltlichtträger  
with fiber optic illumination

Fig. 1 40 mm **RU 8012-13 AS**  
Fig. 2 55 mm **RU 8012-15 AS**  
Fig. 3 75 mm **RU 8012-17 AS**  
Fig. 4 90 mm **RU 8012-19 AS**

Kaltlichtträger allein  
Fiber optic illumination, only  
**RU 8012-95**

**Killian**  
14 cm/5½"

mit Absaugrohr/einhängbar  
with suction tube

Fig. 2 55 mm  
links/left **RU 8012-30 AS**  
rechts/right **RU 8012-31 AS**

Absaugrohr allein  
Suction tube, only

links/left **RU 8012-98**  
rechts/right **RU 8012-99**



**NASENSPEKULA  
NASAL SPECULA**



**Killian**  
14 cm/5½"  
rechtes Blatt verkürzt  
*right blade shortened*  
**RU 8012-20 AS**



**Killian**  
14 cm/5½"  
linkes Blatt verkürzt  
*left blade shortened*  
**RU 8012-21 AS**

**NASENSPEKULA  
NASAL SPECULA**



**Killian-Struycken**  
14 cm/5½"

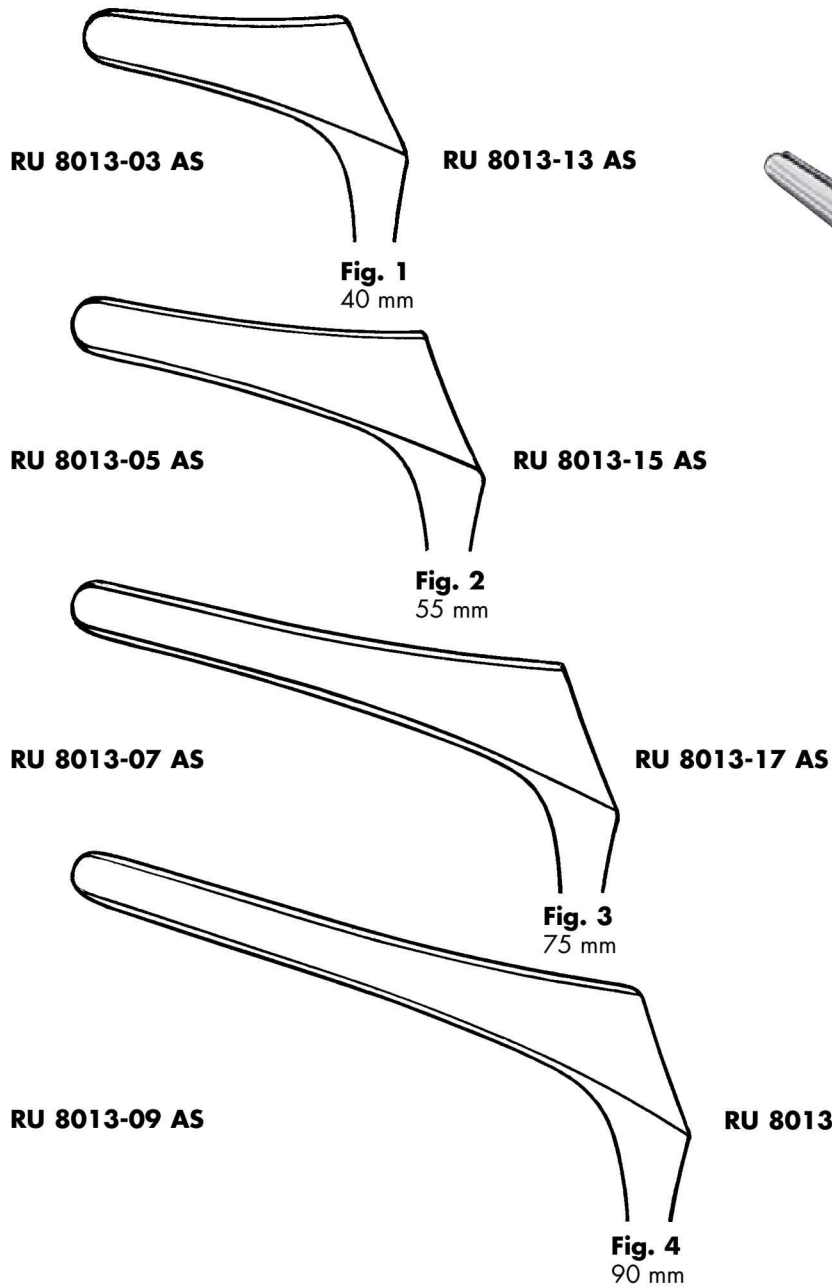

**Killian-Struycken**  
14 cm/5½"



**NASENSPEKULA  
NASAL SPECULA**



**Killian-Struycken**  
14 cm/5½"  
**RU 8013-20 AS**  
rechtes Blatt verkürzt  
right blade shortened



**Killian-Struycken**  
14 cm/5½"  
**RU 8013-21 AS**  
linkes Blatt verkürzt  
left blade shortened

**NASENSPEKULA  
NASAL SPECULA**



**Killian-Walter**  
14 cm/5½"  
dünnes Blatt/*thin valve*

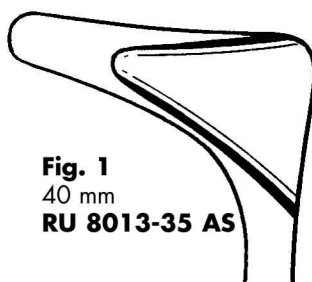

**Fig. 1**  
40 mm  
**RU 8013-35 AS**

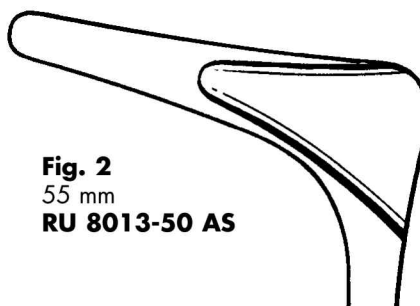

**Fig. 2**  
55 mm  
**RU 8013-50 AS**

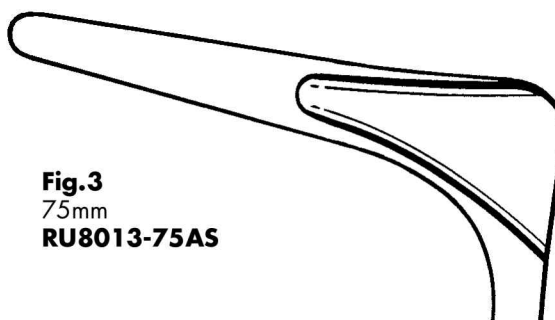

**Fig.3**  
75mm  
**RU8013-75AS**

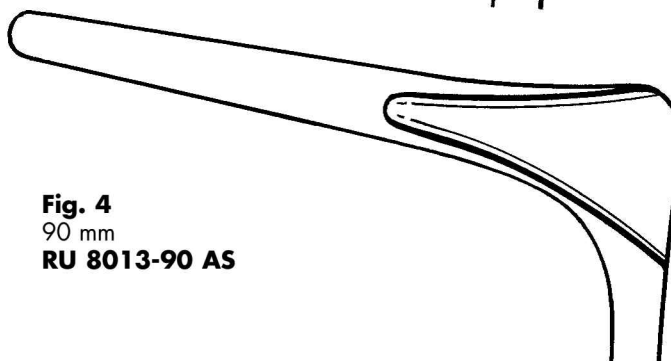

**Fig. 4**  
90 mm  
**RU 8013-90 AS**

**NASENSPEKULA  
NASAL SPECULA**



**Cottle**  
15 cm/6"

- |                      |        |                      |
|----------------------|--------|----------------------|
| <b>RU 8014-35 AS</b> | Fig. 1 | <b>RU 8015-35 AS</b> |
| <b>RU 8014-50 AS</b> | Fig. 2 | <b>RU 8015-50 AS</b> |
| <b>RU 8014-75 AS</b> | Fig. 3 | <b>RU 8015-75 AS</b> |
| <b>RU 8014-90 AS</b> | Fig. 4 | <b>RU 8015-90 AS</b> |

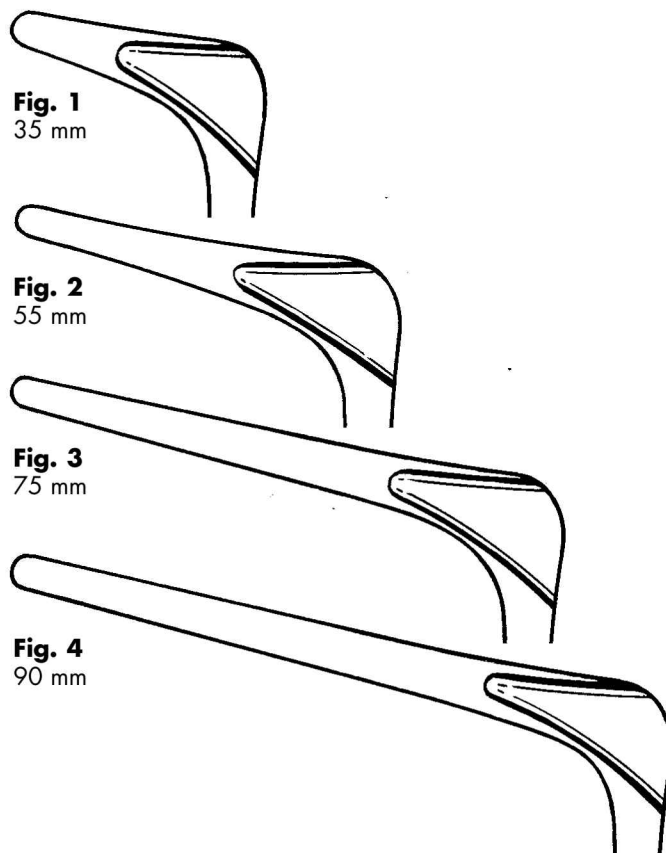

**Fig. 1**  
35 mm

**Fig. 2**  
55 mm

**Fig. 3**  
75 mm

**Fig. 4**  
90 mm



**Cottle-Walter**  
13 cm/5"  
extrem dünnes Blatt  
very thin valve

**RU 8016-35 AS**

**RU 8016-45 AS**

**RU 8016-50 AS**

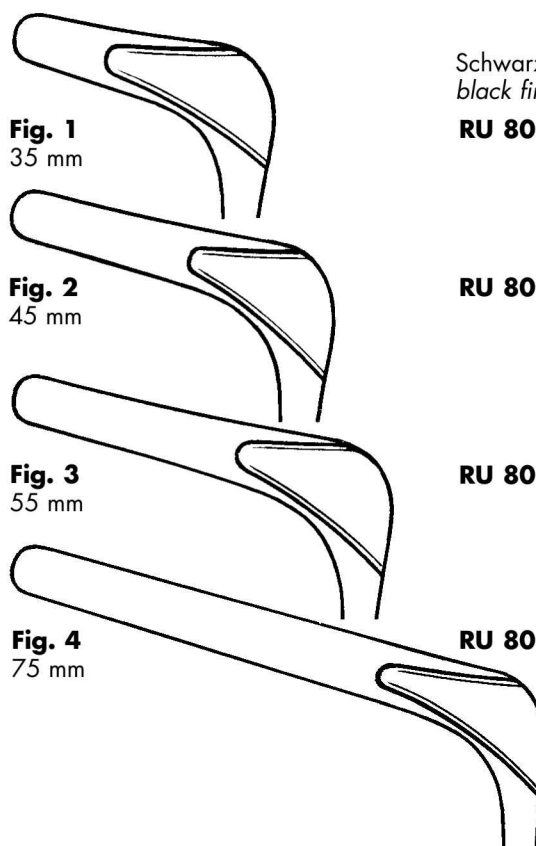

**Fig. 1**  
35 mm

**Fig. 2**  
45 mm

**Fig. 3**  
55 mm

**Fig. 4**  
75 mm

Schwarz  
black finish

**RU 8016-35 ASB**

**RU 8016-45 ASB**

**RU 8016-50 ASB**

**RU 8016-75 ASB**

**FLEXIBLER SPANNARM FÜR NASENSPEKULA**  
**FLEXIBLE ARM FOR NASAL SPECULA**



**RU 6357-50**

Flexibler Spannarm komplett, zur Befestigung an OP-Tischschienen  
*Flexible arm complete, for attachment to operating table*

für/for

RU 8012-03 AS	RU 8017-01 AS
RU 8012-05 AS	RU 8017-02 AS
RU 8012-07 AS	RU 8017-11 AS
RU 8012-09 AS	RU 8017-12 AS

bestehend aus/consisting of:

RU 6357-10  
RU 6357-53  
RU 6357-54  
RU 6357-55



**RU 6357-10**

flexibler Spannarm allein  
*Flexible arm only*



**RU 6357-53**

Haltearm, auseinandernehmbar, zur Fixation im Kugelgelenkkolben RU 6357-54 und zur wahlweisen Aufnahme der Kupplungsköpfe RU 6357-55  
*Holdering Rod, detachable, for fixation in ball and socket joint RU 6357-54 and to hold a desired coupling head RU 6357-55*



**RU 6357-54**

Kugelgelenkkolben zum Befestigen an der OP-Tischschiene und zur Aufnahme des Haltearms RU 6357-53

*Ball and Socket Joint for fixation of holding rod at the operating table RU 6357-53*



**RU 6357-55**

Kupplungskopf, seitlich offen zur Aufnahme von 1 Spannarm RU 6357-10

*Coupling head, lateral open, to hold 1 flexible arm RU 6357-10*

**NASENSPEKULA  
NASAL SPECULA**

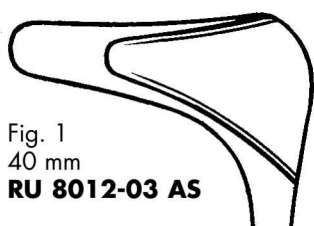

Fig. 1  
40 mm  
**RU 8012-03 AS**

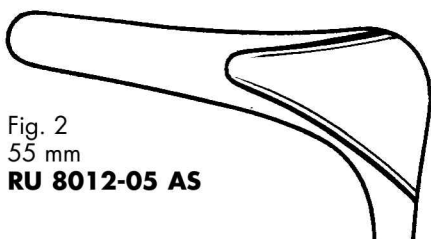

Fig. 2  
55 mm  
**RU 8012-05 AS**

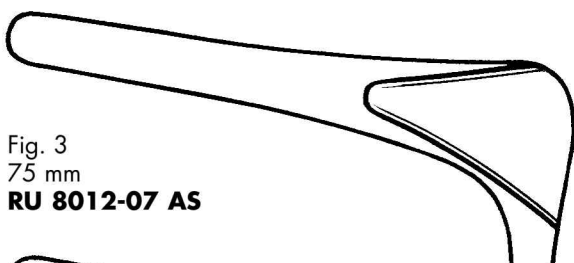

Fig. 3  
75 mm  
**RU 8012-07 AS**

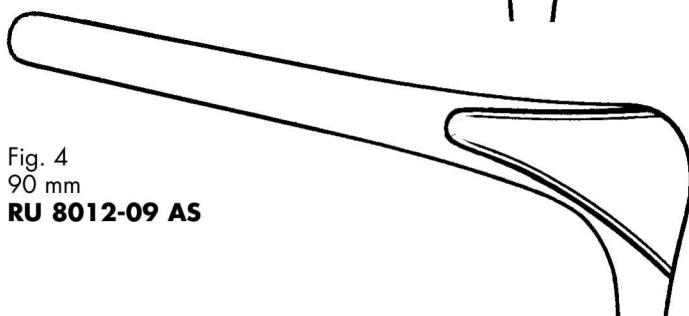

Fig. 4  
90 mm  
**RU 8012-09 AS**



**Killian**  
14 cm/5½"  
für flexiblen Spannarm  
*for flexible arm*

Daten zum flexiblen Spannarm entnehmen Sie bitte Seite 270  
*For flexible arm please refer to page 270*

**NASENSPEKULA  
NASAL SPECULA**



linkes Blatt verkürzt  
mit Zähnen  
*left blade shortened  
with teeth*



rechtes Blatt/  
*right blade*  
55 mm  
**RU 8017-01 AS**



rechtes Blatt/  
*right blade*  
75 mm  
**RU 8017-02 AS**



rechtes Blatt verkürzt  
mit Zähnen  
*right blade shortened  
with teeth*



linkes Blatt/  
*left blade*  
55 mm  
**RU 8017-11 AS**

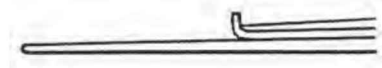

linkes Blatt/  
*left blade*  
75 mm  
**RU 8017-12 AS**

**Killian**

14 cm/5½"

für flexiblen Spannarm Seite 270  
*for flexible arm on page 270*

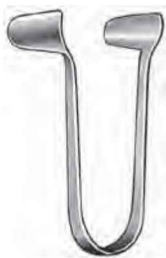

**Tudichum (Goldsmith)**

6,5 cm/2½"  
Satz/Set  
**RU 8018-00**



**Thudichum-Soft**

7 cm/2¾"



**Bowman**

7 cm/2¾"  
**RU 9012-07**

**RU 8018-00** bestehend aus/consisting of:



**RU 8018-01**



**RU 8018-02**



**RU 8018-03**

Blattlänge Length	Standard Standard	Isoliert Insulated
12 mm	RU 8018-21	RU 8018-31
14 mm	RU 8018-22	RU 8018-32
16 mm	RU 8018-23	RU 8018-33
18 mm	RU 8018-24	RU 8018-34
20 mm	RU 8018-25	RU 8018-35
22 mm	RU 8018-26	RU 8018-36
24 mm	RU 8018-27	RU 8018-37
27 mm	RU 8018-27	RU 8018-38

**POLYPENSCHNÜRER  
NASAL SNARES**



**RU 8020-50**  
Rohraufsatz allein  
*Snare tube only*

**RU 8020-55**  
Drahtführer allein  
*Guide only*

**Krause**  
26 cm/10¼"  
**RU 8020-26**



mit 2 Aufsätzen  
*with 2 snare tubes*

**RU 8021-50**  
Rohraufsatz vertikal  
*vertikal snare tube*

**RU 8021-55**  
Rohraufsatz horizontal  
*horizontal snare tube*

**Krause-Voss**  
26 cm/10¼"  
**RU 8021-26**



**Lange-Wilde**  
24 cm/9½"  
**RU 8022-24**

**Schnürerdraht  
Snare wire**

10 m/33ft.



Ø 0,3 mm **RU 7856-03**  
Ø 0,4 mm **RU 7856-04**



Packung à 12 Stück  
*package of 1 dozen each*

Ø 0,3 mm **RU 8024-10**  
Ø 0,35 mm **RU 8024-11**

Packung à 100 Stück  
*package of 100 pieces*

Ø 0,3 mm **RU 8024-10/00**  
Ø 0,35 mm **RU 8024-11/00**

**ZERSTÄUBER  
ATOMIZERS**

**Verchromte Zerstäuber, inkl. 12 ml Flakon**  
*Chromium-plated atomizers, incl. 12 ml glass bottle*



**RU 8025-01**

für die Nase, gerade  
*for nose, straight*

**RU 8025-12**

Ersatzflakon 12 ml, alleine  
*spare glass bottle, 12 ml, only*



**RU 8025-02**

für Nasen- und Rachenraum, aufwärts gebogen  
*for nasopharynx, curved upwards*



**RU 8025-03**

für Kehlkopf, abwärts gebogen  
*for larynx, curved downwards*



**RU 8026-10**

**RU 8026-00** Universal-Zerstäuber mit einstellbarer Spitze, Nasenolive, Schraubflasche, 36 ml und Gebläse, verchromt  
*Universal atomizer with adjustable nozzle, nasal tip, glass bottle, 36 ml and rubber bulb chromium-plated*

**RU 8026-10** Nasenolive extra  
*Nasal tip only*

**RU 8026-36** Gasflasche 36 ml, alleine  
*Spare glass bottle 36 ml, only*





**RU 8027-00**

**RU 8027-00** Universal-Kokainzerstäuber mit einstellbarer Spitze,  
Spitzflakon 6 ml, Metallfuß und Gebläse  
*Universal cocaine atomizer with adjustable nozzle,  
glass bottle 6 ml, metal stand and rubber bulb*

**RU 8027-06** Ersatzflakon 6 ml, alleine  
*Spare glass bottle 6 ml, only*

**RU 8027-10** Metallfuß alleine  
*Metal stand only*



**RU 8028-10** Gebläse mit Schlauch, 25 cm/10"  
*Rubber bulb with tube, 25 cm/10"*

**NASENSPIEGEL, SINUSKLEMMEN, NASENPINZETTEN**  
**NASAL MIRROR, SINUS FORCEPS, NASAL FORCEPS**

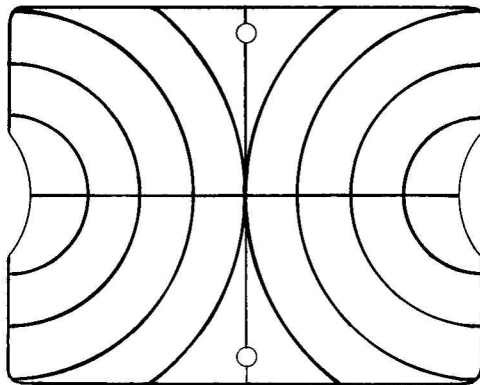

**Glatzel**  
200 x 130 mm/8" x 5"  
**RU 8029-01**



**Lister**  
16 cm/6¼"  
**RU 3810-16**  
Sinusklemme  
*Sinus forceps*



**Troeltsch  
(Wilde)**

cm	in	
11,0	4 <sup>3</sup> / <sub>8</sub> "	<b>RU 7860-11</b>
12,0	4 <sup>3</sup> / <sub>4</sub> "	<b>RU 7860-12</b>
15,0	6"	<b>RU 7860-15</b>
18,0	7"	<b>RU 7860-18</b>

2,2 mm



**Jansen  
(Gruenwald)**

1 mm



**Jansen  
(Fine)**



**Jansen**

16 cm/6¼"	<b>RU 7864-16</b>	<b>RU 7864-16/1</b>	<b>RU 7865-16</b>
18 cm/7"	<b>RU 7864-18</b>	<b>RU 7864-18/1</b>	
20 cm/8"	<b>RU 7864-20</b>	<b>RU 7864-20/1</b>	<b>RU 7865-20</b>

**NASENTAMPONZANGEN, SEPTUMZANGEN**  
**NASAL DRESSING FORCEPS, SEPTUM FORCEPS**



**Tilley**  
16 cm/6¼"  
**RU 8033-16**



**Westmacott (West)**  
20 cm/8"  
**RU 8036-20**



**Lubet-Barbon**  
20 cm/8"  
**RU 8037-20**



**Hartmann**  
16 cm/6¼"  
**RU 8050-16**



**Hartmann**  
20 cm/8"  
**RU 8050-20**



**Heymann**  
18 cm/7"  
**RU 8058-18**



**Heymann-Knight**  
19 cm/7½"  
**RU 8059-19**

**POLYPENZANGEN, SEPTUMZANGEN**  
**POLYPUS FORCEPS, SEPTUM FORCEPS**



**Craig**  
17,5 cm/7"  
**RU 8065-18**



**RU 8066-01**      **RU 8066-02**

**Craig-Domnick**  
17,5 cm/7"

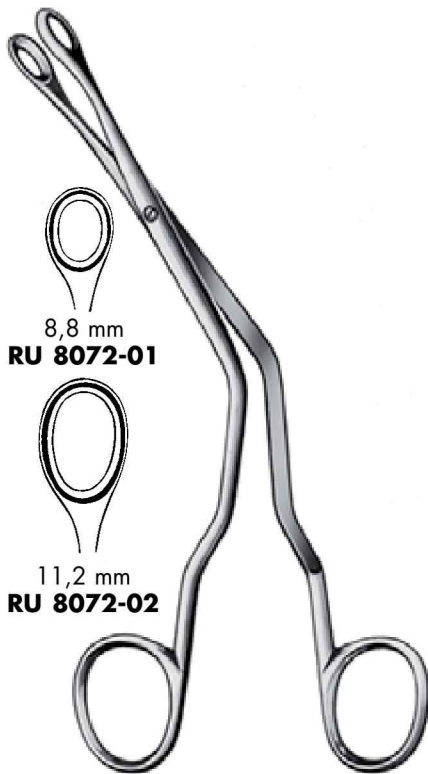

8,8 mm  
**RU 8072-01**

11,2 mm  
**RU 8072-02**

**Luc**  
20 cm/8"

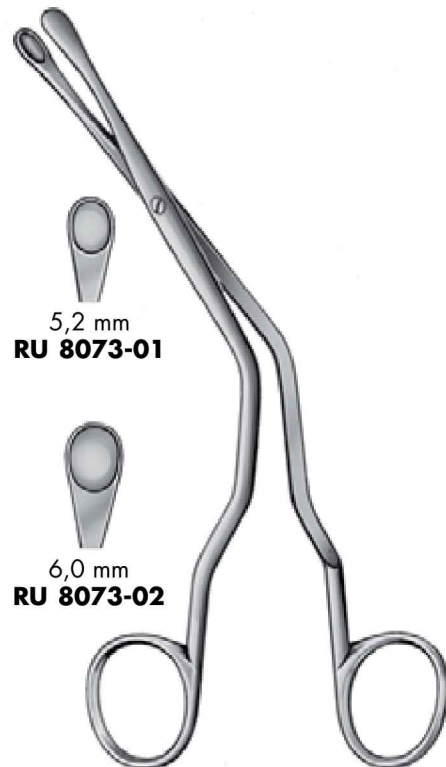

5,2 mm  
**RU 8073-01**

6,0 mm  
**RU 8073-02**

**Luc**  
20 cm/8"

**SEPTUMZANGEN, LÖFFELZÄNGCHEN  
SEPTUM FORCEPS, CUP-SHAPED FORCEPS**



**Strümpel-Voss**  
11 cm  
**RU 7884-11**



**Strümpel**  
8,5 cm/3¾"  
10 cm/4"  
**RU 7884-09**  
**RU 7884-10**



**Bruenings**  
19 cm/7½"



Ø 3 mm  
**RU 8079-01**

**SIEBBEINZANGEN  
ETHMOIDAL FORCEPS**

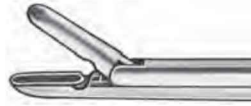

Maul jaw mm	Schaftlänge length of shaft 12 cm/4¾"	Schaftlänge length of shaft 17 cm/6¾"
3 x 10	<b>RU 8080-00</b>	<b>RU 8080-10</b>
2 x 10	<b>RU 8080-02</b>	<b>RU 8080-12</b>
2,5 x 8	<b>RU 8080-03</b>	
<b>PROCLEAN</b> 3 x 10	<b>RU 8080-00 PC</b>	



Maul jaw mm	Schaftlänge length of shaft 12 cm/4¾"
3 x 10	<b>RU 8081-00</b>
<b>PROCLEAN</b> 3 x 10	<b>RU 8081-00 PC</b>

**PROCLEAN**<sup>®</sup>

- einfache Reinigung
- gründliche Desinfektion
- sorgfältige Sterilisation
- easy cleaning
- thorough disinfecting
- accurate sterilizing



**Takahashi**

3 mm		<b>RU 8082-01</b>
3,6 mm		<b>RU 8082-02</b>
4,2 mm		<b>RU 8082-03</b>

3 mm		<b>RU 8083-01</b>
------	--	-------------------



3 x 4 mm		<b>RU 8084-01</b>
3,5 x 6 mm		<b>RU 8084-02</b>

**Watson-Williams**

45° aufgebogen/angled up  
mit Fanggitter/with basket  
ohne Fanggitter/without basket



**SEPTUMZANGEN, BIOPSIE- UND FASSZANGEN  
SEPTUM FORCEPS, BIOPSY AND GRASPING FORCEPS**

6 mm  
**RU 8085-01**

8 mm  
**RU 8085-02**

10 mm  
**RU 8085-03**

6,5 mm  
**RU 8086-00**

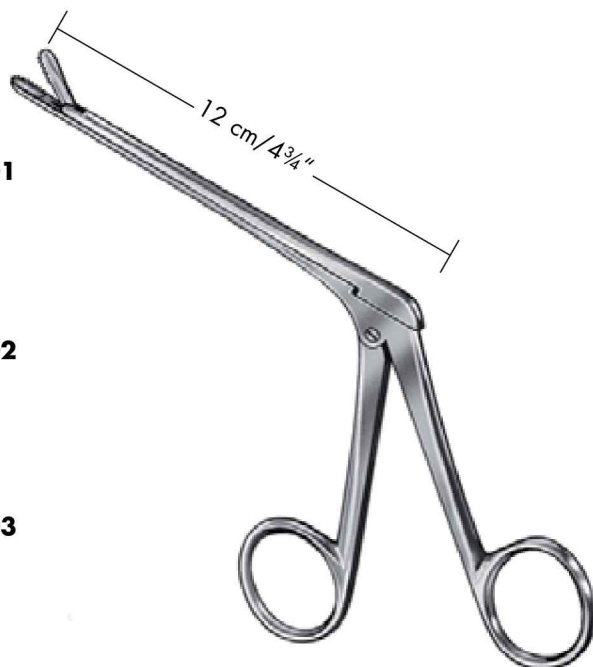

**Watson-Williams**  
19 cm / 7 1/2"

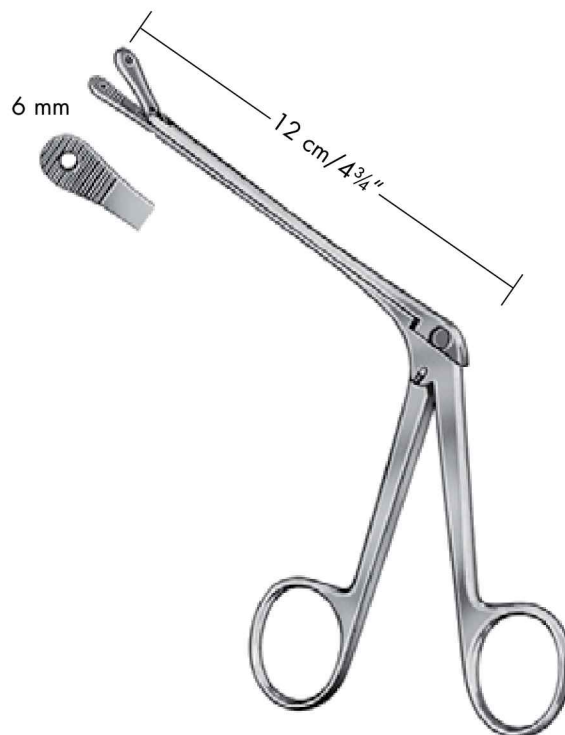

**Ferris-Smith**  
**RU 8087-00**



8,5 x 4,0 mm



**RU 8089-00** gerade, *straight*

8,5 x 4,0 mm



**RU 8089-01** 30° aufgewinkelt, 30° *angled up*

Biopsie- und Faßzange mit Absaugkanal  
*Biopsy and grasping forceps with suction tube*

**SIEBBEINZANGEN  
ETHMOIDAL FORCEPS**

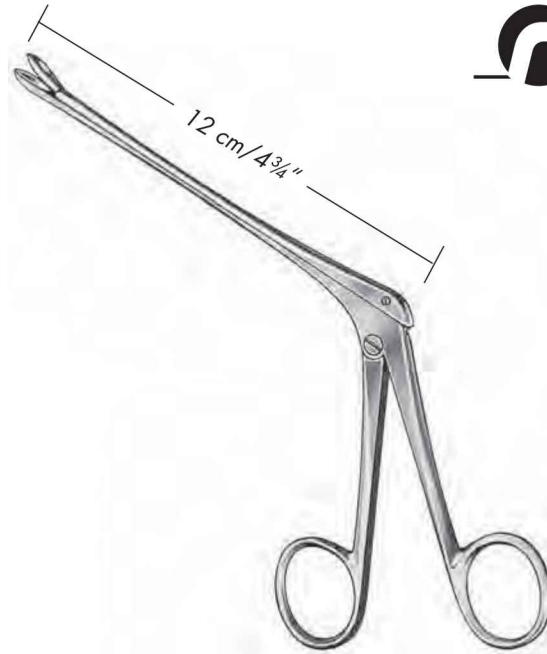









- einfache Reinigung
- gründliche Desinfektion
- sorgfältige Sterilisation

- easy cleaning
- thorough disinfecting
- accurate sterilizing



**Weil-Blakesley**

			
	gerade/straight	45° aufwärts gebogen 45° angled up	90° aufwärts gebogen 90° angled up
2,5 mm 	<b>RU 8090-00 RU 8090-00 PC*</b>	<b>RU 8091-00 RU 8091-00 PC*</b>	<b>RU 8092-00</b>
3,0 mm 	<b>RU 8090-01 RU 8090-01 PC*</b>	<b>RU 8091-01 RU 8091-01 PC*</b>	<b>RU 8092-01</b>
3,5 mm 	<b>RU 8090-02 RU 8090-02 PC*</b>	<b>RU 8091-02 RU 8091-02 PC*</b>	<b>RU 8092-02</b>
4,5 mm 	<b>RU 8090-03 RU 8090-03 PC*</b>	<b>RU 8091-03 RU 8091-03 PC*</b>	<b>RU 8092-03</b>
5,0 mm 	<b>RU 8090-04 RU 8090-04 PC*</b>	<b>RU 8091-04</b>	<b>RU 8092-04</b>
6,0 mm 	<b>RU 8090-05 RU 8090-05 PC*</b>	<b>RU 8091-05</b>	<b>RU 8092-05</b>

\* =  PROCLEAN<sup>®</sup>



**SIEBBEINZANGEN  
ETHMOID FORCEPS**

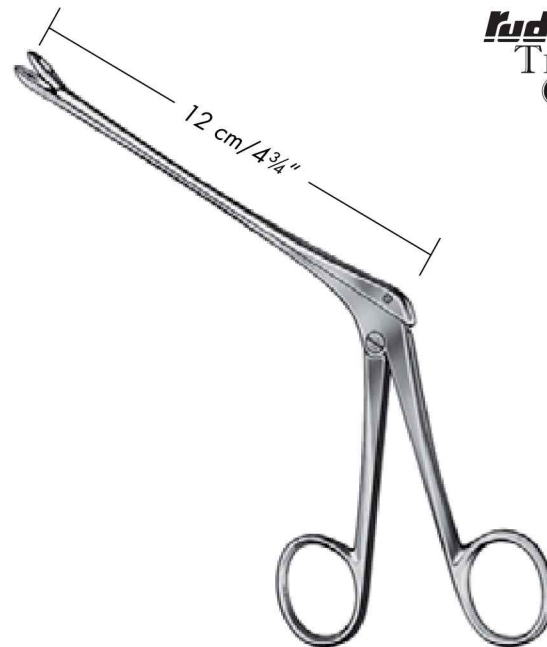

**Rudolf**  
TITAN  
CERAMED®

**Weil-Blakesley**

		gerade/straight			45° aufwärts gebogen 45° angled up			90° aufwärts gebogen 90° angled up	
		TITAN	TITAN CERAMED®		TITAN	TITAN CERAMED®		TITAN	TITAN CERAMED®
2,5mm	<b>RU 8090-00 TI</b>	<b>RU 8090-00 TI/CR</b>	<b>RU 8091-00 TI</b>	<b>RU 8091-00 TI/CR</b>	<b>RU 8092-00 TI</b>	<b>RU 8092-00 TI/CR</b>			
3,0 mm	<b>RU 8090-01 TI</b>	<b>RU 8090-01 TI/CR</b>	<b>RU 8091-01 TI</b>	<b>RU 8091-01 TI/CR</b>	<b>RU 8092-01 TI</b>	<b>RU 8092-01 TI/CR</b>			
3,5 mm	<b>RU 8090-02 TI</b>	<b>RU 8090-02 TI/CR</b>	<b>RU 8091-02 TI</b>	<b>RU 8091-02 TI/CR</b>	<b>RU 8092-02 TI</b>	<b>RU 8092-02 TI/CR</b>			
4,2 mm	<b>RU 8090-03 TI</b>	<b>RU 8090-03 TI/CR</b>	<b>RU 8091-03 TI</b>	<b>RU 8091-03 TI/CR</b>	<b>RU 8092-03 TI</b>	<b>RU 8092-03 TI/CR</b>			
5,0 mm	<b>RU 8090-04 TI</b>	<b>RU 8090-04 TI/CR</b>	<b>RU 8091-04 TI</b>	<b>RU 8091-04 TI/CR</b>	<b>RU 8092-04 TI</b>	<b>RU 8092-04 TI/CR</b>			
6,0 mm	<b>RU 8090-05 TI</b>	<b>RU 8090-05 TI/CR</b>	<b>RU 8091-05 TI</b>	<b>RU 8091-05 TI/CR</b>	<b>RU 8092-05 TI</b>	<b>RU 8092-05 TI/CR</b>			

**SIEBBEINZANGEN  
ETHMOIDAL FORCEPS**

**Neu entwickelte Blakesley Siebbeinzangen mit verbessertem, modifiziertem, durchschneidendem Maul.  
New developed Blakesley ethmoid forceps with improved, modified, intersecting jaw.**



**Blakesley-Rudolf**



Größe Size	Maul gerade straight jaw	Maul aufgewinkelt jaw angled up	Maul nach links schneidend left cutting	Maul nach rechts schneidend right cutting
Fig. 0/2,5 mm	<b>RU 8090-20</b>	<b>RU 8091-20</b>		
Fig. 2/3,5 mm	<b>RU 8090-22</b>	<b>RU 8091-22</b>	<b>RU 8090-22 L</b>	<b>RU 8090-22 R</b>
Fig. 4/4,8 mm	<b>RU 8090-24</b>	<b>RU 8091-24</b>		





**Mit Absaugung/with suction**

Fig. 2/3,5 mm	<b>RU 8090-22 SU</b>	<b>RU 8091-22 SU</b>
---------------	----------------------	----------------------

**CONCHOTOME  
NASAL CUTTING FORCEPS**



**Struycken**

-  **RU 8094-00**  
1,0 x 19 mm
-  **RU 8094-00/01**  
1,2 x 19 mm





**Hajek**

-  **RU 8095-00**



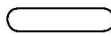
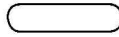

**Myles**

-  **RU 8100-01**  
2,0 x 10 mm
-  **RU 8100-02**  
2,5 x 12 mm
-  **RU 8100-03**  
3,0 x 14 mm
-  **RU 8100-04**  
3,5 x 15 mm

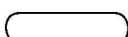

**Hajek**

-  **RU 8102-01**  
3,0 x 12 mm
-  **RU 8102-02**  
3,5 x 14 mm
-  **RU 8102-03**  
4,0 x 16 mm





**Grünwald-Henke**

-  **RU 8103-21**  
2,5 x 11 mm
-  **RU 8103-22**  
3,0 x 11 mm





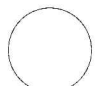

**Hartmann**

-  **RU 8108-05**  
5 mm
-  **RU 8108-07**  
7 mm
-  **RU 8108-09**  
9 mm
-  **RU 8108-11**  
11 mm





**Hartmann**

-  **RU 8108-15**  
5 mm
-  **RU 8108-17**  
7 mm
-  **RU 8108-19**  
9 mm
-  **RU 8108-21**  
11 mm

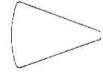

**Schmeden**

-  **RU 8109-01**  
5 mm
-  **RU 8110-01**  
8 mm
-  **RU 8110-02**  
10 mm

**SEPTUMZANGEN, SEPTUMSCHEREN  
SEPTUM FORCEPS, SEPTUM SCISSORS**



**Middleton-Jansen**  
19 cm/7½"  
**RU 8121-19**



**Middleton-Jansen**  
19 cm/7½"  
**RU 8122-19**



**Kazanjan**  
18 cm/7"  
**RU 8125-18**







**Caplan**  
20 cm/8"  
**RU 8126-20**



17 cm/6¾"  
**RU 5703-17**

**KEILBEINSTANZEN  
SPHENOIDAL PUNCHES**



-  **RU 8130-01**  
4 mm
-  **RU 8130-02**  
4 mm
-  **RU 8130-03**  
3,5 mm
-  **RU 8130-04**  
3,5 mm



Bissbreite  
Width of bite

-  3 mm **RU 8134-03**
-  4 mm **RU 8134-04**
-  5 mm **RU 8134-05**
-  6 mm **RU 8134-06**

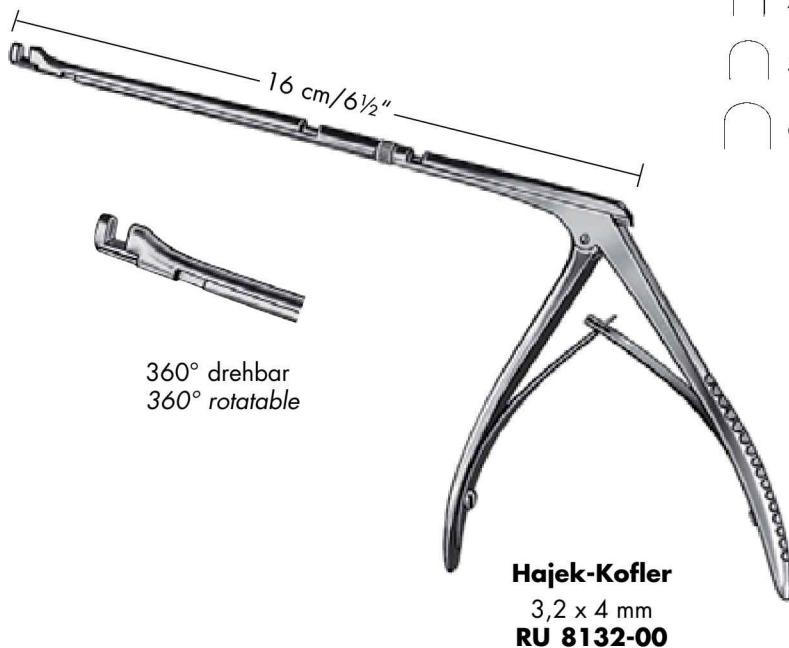

**SCHARFE NASENZANGEN, NASENPLASTIKMESSER  
ADENOID CUTTING FORCEPS, RHINOPLASTIC AND NASAL KNIVES**



**Jurasz**  
22 cm/8¾"



**RU 8139-01**



**RU 8139-02**



**RU 8139-03**



gebogen/*curved*  
**RU 8141-01**

**Joseph**  
15 cm/6"  
spitz/*sharp*  
gerade/*straight*  
**RU 8140-01**



gebogen/*curved*  
**RU 8143-01**

**Joseph**  
15 cm/6"  
stumpf/*blunt*  
gerade/*straight*  
**RU 8142-01**



**Converse**  
15 cm/6"  
**RU 8144-15**



**Joseph**  
14 cm/5½"  
**RU 8145-15**

**NASENPLASTIKMESSER, RITZMESSER  
RHINOPLASTIC AND NASAL KNIVES**



**Cottle**  
15 cm/6"  
RU 8146-15



**Cottle**  
14 cm/5½"  
RU 8147-14



**Freer**  
16 cm/6¼"  
RU 8149-02



**Joseph**  
16,5 cm/6½"  
RU 8152-16



**Maltz**  
16,5 cm/6½"  
RU 8153-16



**Fomon**  
15 cm/6"  
RU 8154-15



**Masing**  
13,5 cm/5¼"  
RU 8155-13



**Masing**  
14 cm/5½"  
RU 8156-14



**Freer**  
19 cm/7½"  
RU 8171-19

**SEPTUMMESSER  
SEPTUM KNIVES**



**Ballenger**  
20 cm/8"

**RU 8200-03  
RU 8200-04  
RU 8200-05**



3 mm  
4 mm  
5 mm

**RU 8201-03  
RU 8201-04  
RU 8201-05**



**Ballenger**  
20 cm/8"



**Bruenings**  
16,5 cm/6½"  
**RU 8202-16**

Ersatzmesser  
Spare knives  
**RU-8202-20**



**SEPTUM-ELEVATORIEN**  
**SEPTUM ELEVATORS**



3 mm **RU-8203-03**  
4 mm **RU-8203-04**  
5 mm **RU-8203-05**

**Mc Kenty**  
15 cm/6"



**Halle**  
18,5 cm/7¼"  
stumpf/blunt  
**RU 8204-16**

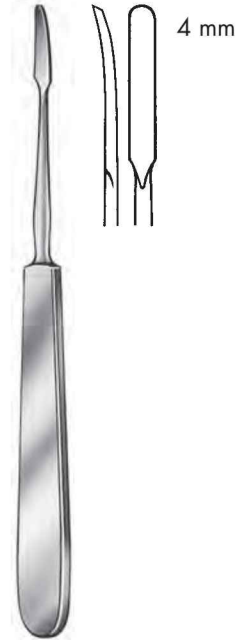

**Joseph**  
16,5 cm/6½"  
**RU 8206-16**



**Killian**  
18 cm/7¼"  
**RU 8209-18**



**Cottle**  
19,5 cm/7½"  
**RU 8210-19**



**Freer-Joseph**  
20 cm/7¾"  
**RU 8211-20**

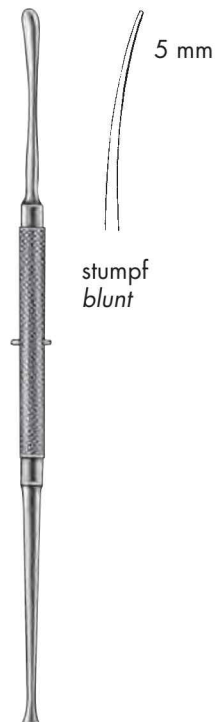

**Freer**  
19 cm/7½"  
**RU 8212-19**

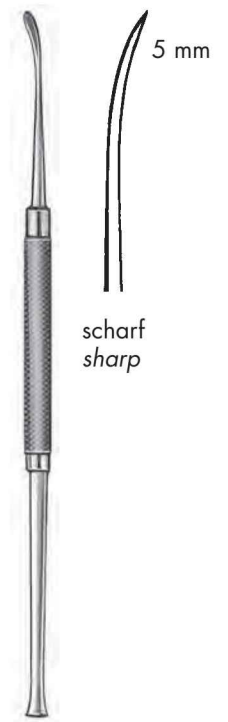

**Freer**  
19 cm/7½"  
**RU 8213-19**

**SEPTUM-ELEVATORIEN**  
**SEPTUM ELEVATORS**

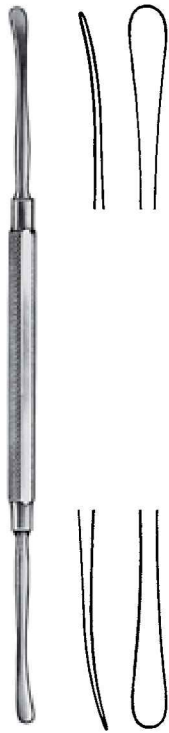

**Freer-USA Mod.**  
20 cm/8¾"  
**RU 8214-20**

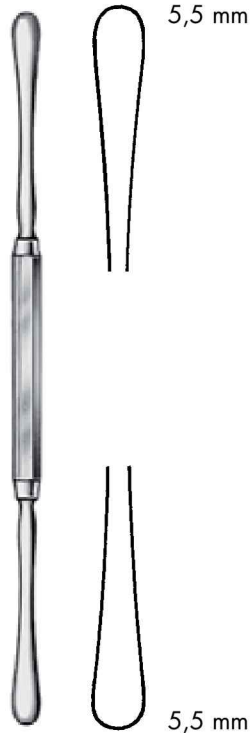

**Hajek-Ballenger**  
19 cm/7½"  
**RU 8215-20**

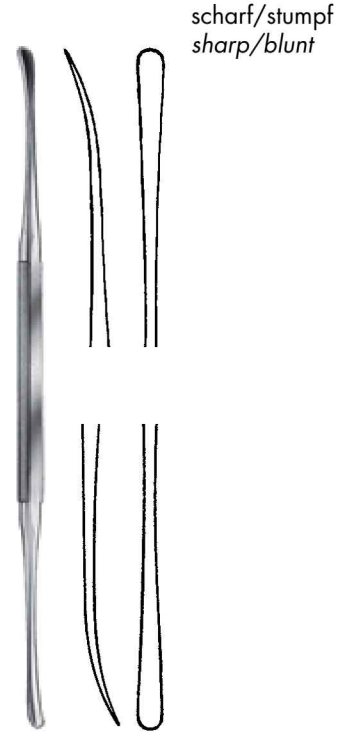

**Freer**  
18 cm/7"  
**RU 8216-18**



**Freer-Yasargil**  
18,5 cm/7¼"  
scharf/sharp  
**RU 8217-18**



**Howarth**  
21,5 cm/8½"  
**RU 8218-21**



**Mc Kenty**  
22 cm/8¾"  
**RU 8219-22**

**SEPTUM-ELEVATORIEN  
SEPTUM ELEVATORS**



**Freer**  
18,5 cm/7¼"  
**RU 8220-19**



**Freer**  
17,5 cm/7"  
**RU 8221-17**



**Killian**  
18,5 cm/7¼" **RU 8222-18**  
22 cm/8¾" **RU 8222-22**



**Cottle**  
23 cm/9"  
**RU 8224-23**



**Killian**  
18,5 cm/7¼"  
scharf/stumpf, sharp/blunt  
**RU 8226-18**

**RASPATORIEN, ELEVATORIEN  
RASPATORIES, ELEVATORS**



**Pierce**  
21 cm/8¼"  
**RU 8228-21**



**Pennington**  
21 cm/8¼"  
**RU 8230-21**



17 cm/6¾"

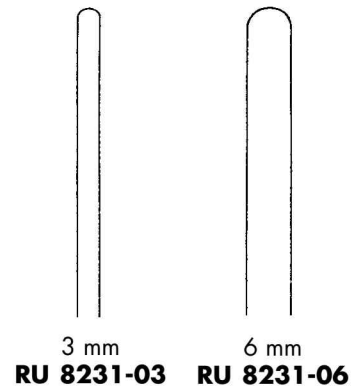

3 mm  
**RU 8231-03**

6 mm  
**RU 8231-06**



17 cm/6¾"  
6 mm      8 mm  
**RU 5394-06    RU 5394-08**



**Mc Donald**  
19 cm/7½"  
**RU 5434-19**



4 mm  
16,5 cm/6½"  
**RU 8231-16**



**Freer**  
18 cm/7"  
**RU 8232-18**

**ELEVATORIEN  
ELEVATORS**



18 cm/7"  
**RU 8236-18**



**Cottle**  
20 cm/8"  
**RU 8237-20**



**Joseph (Cottle)  
Masing**  
22 cm/8¾"  
**RU 8238-22**



**Masing**  
20,5 cm/8¾"    22,5 cm/8¾"  
**RU 8239-20    RU 8239-22**



**Joseph**  
18 cm/7"  
**RU 8240-16**  
Periost-Elevator  
*Periosteum elevator*

**OSTEOTOME, PRÄPARATOREN  
OSTEOTOMES, DISSECTORS**

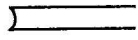

**RU 8241-03**  
3,0 mm

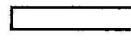

**RU 8241-13**  
3,0 mm

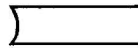

**RU 8241-05**  
5,0 mm

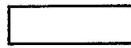

**RU 8241-15**  
5,0 mm



**Paulsen**  
8 cm/3 1/8"



**Paulsen**  
20,5 cm/8"

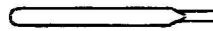

**RU 8241-20**  
2,5 mm



**RU 8241-21**  
3,5 mm



**RU 8241-22**  
4,5 mm



**Paulsen**  
20,5 cm/8"



**RU 8241-30**  
5,0 mm



**RU 8241-31**  
8,0 mm

**OSTEOTOME, FLACH- UND HOHLMEISSEL  
OSTEOTOMES, CHISELS AND GOUGES**



18,5 cm/7¼"

Nasenseptum-Osteotome  
Osteotomes for septum

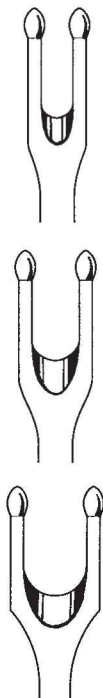

4 mm  
**RU 8243-04**

6 mm  
**RU 8243-06**

8 mm  
**RU 8243-08**



4 mm

**Freer**

16 cm/6¼"  
**RU 8244-16**

Flachmeißel, gebogen  
Septum chisel, curved



4 mm

**Freer**

16 cm/6¼"  
**RU 8245-16**

Flachmeißel, gerade  
Septum chisel, straight



6 mm

**Freer**

15 cm/6"  
**RU 8246-15**

Septum-Hohlmeißel  
Septum gouge



2 mm **RU 8247-02**  
4 mm **RU 8247-04**  
6 mm **RU 8247-06**  
8 mm **RU 8247-08**

**Ballenger**  
16 cm/6¼"

Septum-Hohlmeißel  
Septum gouges

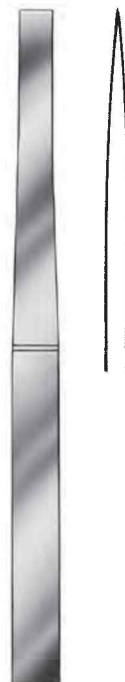

**Converse**

18 cm/7"

2 mm **RU 8248-02**  
3 mm **RU 8248-03**  
4 mm **RU 8248-04**  
5 mm **RU 8248-05**  
6 mm **RU 8248-06**  
7 mm **RU 8248-07**  
8 mm **RU 8248-08**  
9 mm **RU 8248-09**  
10 mm **RU 8248-10**  
11 mm **RU 8248-11**  
12 mm **RU 8248-12**  
14 mm **RU 8248-14**

Osteotome  
Osteotomes

**OSTEOTOME  
OSTEOTOMES**

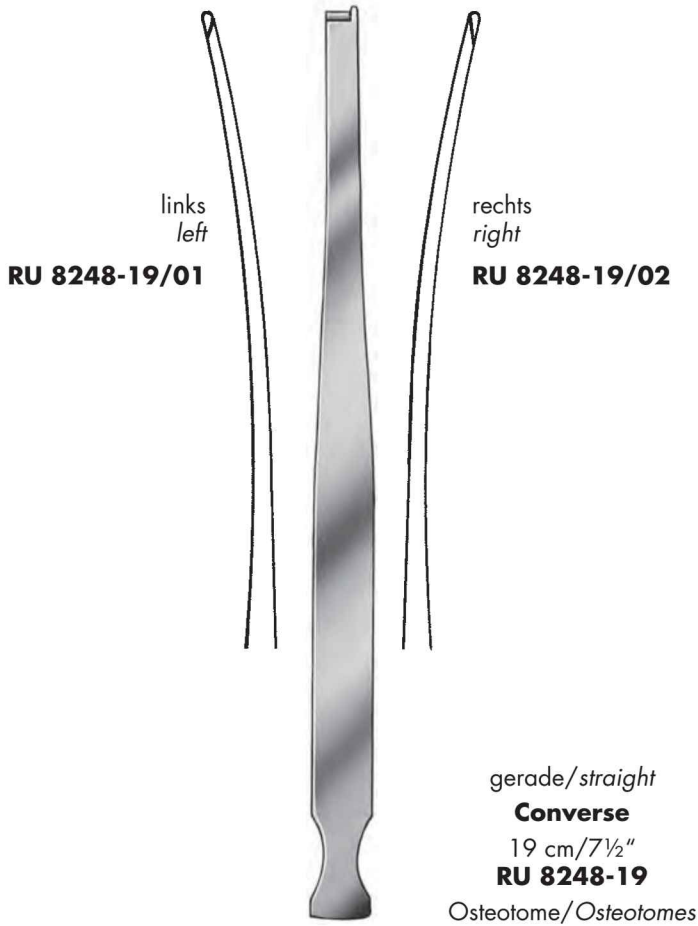

**Sheehan (Rubin)**

16 cm/6¼"

- 2 mm **RU 8249-02**
- 3 mm **RU 8249-03**
- 4 mm **RU 8249-04**
- 5 mm **RU 8249-05**
- 6 mm **RU 8249-06**
- 7 mm **RU 8249-07**
- 8 mm **RU 8249-08**
- 9 mm **RU 8249-09**
- 10 mm **RU 8249-10**
- 11 mm **RU 8249-11**
- 12 mm **RU 8249-12**
- 15 mm **RU 8249-15**

Osteotome  
Osteotomes



**Mini-Lambotte**

12,5 cm/5"

- 2 mm **RU 5332-02**
- 3 mm **RU 5332-03**
- 4 mm **RU 5332-04**
- 6 mm **RU 5332-06**
- 8 mm **RU 5332-08**
- 10 mm **RU 5332-10**
- 12 mm **RU 5332-12**
- 15 mm **RU 5332-15**

Osteotome  
Osteotomes



12,5 cm/5"  
gebogen/curved

- 2 mm **RU 5332-22**
- 4 mm **RU 5332-24**
- 6 mm **RU 5332-26**
- 8 mm **RU 5332-28**
- 10 mm **RU 5332-30**
- 12 mm **RU 5332-32**

Osteotome  
Osteotomes



**FLACH- UND HOHLMEISSEL, OSTEOTOME  
CHISELS AND GOUGES, OSTEOTOMES**

Hohlmeißel/Gouges



**Killian**  
16 cm/6¼"  
**RU 8250-16**

**Killian-Claus**  
16 cm/6¼"  
**RU 8252-16**



2 mm **RU 8253-02**  
4 mm **RU 8253-04**  
6 mm **RU 8253-06**  
7 mm **RU 8253-07**  
9 mm **RU 8253-09**  
12 mm **RU 8253-12**

**Cottle**  
18 cm/7"  
Osteotome/Osteotomes

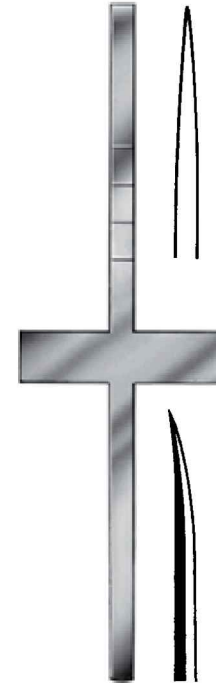

2 mm **RU 8253-22**  
4 mm **RU 8253-24**  
6 mm **RU 8253-26**  
7 mm **RU 8253-27**  
9 mm **RU 8253-29**  
12 mm **RU 8253-32**

**Cottle**  
18 cm/7"  
Osteotome/Osteotomes

2 mm **RU 8253-52**  
4 mm **RU 8253-54**  
6 mm **RU 8253-56**  
gebogen/curved



**Cottle**  
18 cm/7"  
2 mm **RU 8254-02**  
4 mm **RU 8254-04**  
6 mm **RU 8254-06**  
7 mm **RU 8254-07**  
9 mm **RU 8254-09**  
12 mm **RU 8254-12**  
Flachmeißel  
Chisels



**Cottle**  
18,5 cm/7¼"  
gebogen/curved  
2 mm **RU 8254-52**  
4 mm **RU 8254-54**  
6 mm **RU 8254-56**  
Flachmeißel  
Chisels

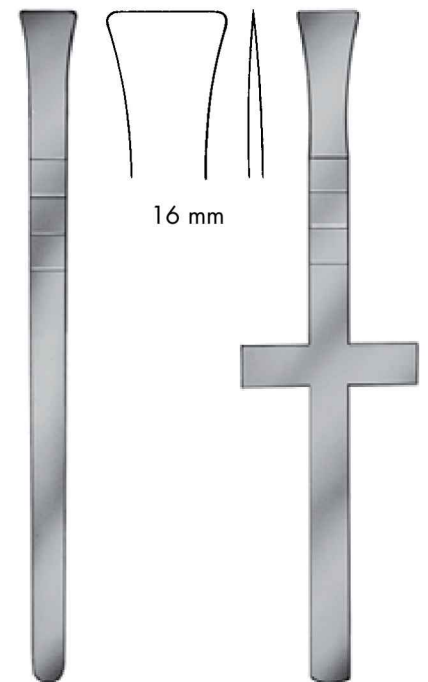

**Cottle**  
18 cm/7"  
**RU 8255-16/01**

**Cottle**  
18 cm/7"  
**RU 8255-16/02**

Osteotome/Osteotomes

**SEPTUM-MEISSEL, OSTEOTOME**  
**SEPTUM CHISELS, OSTEOTOMES**

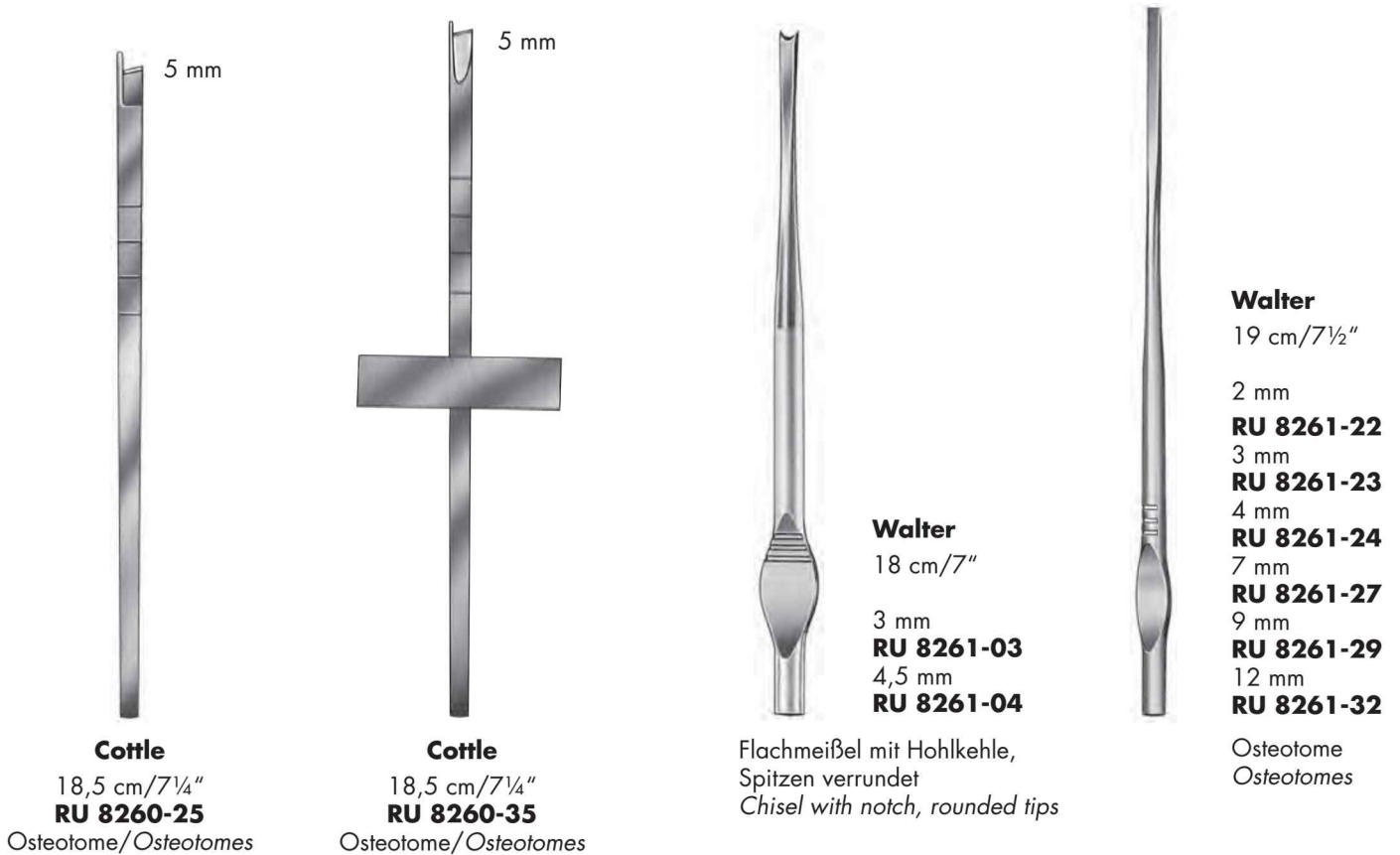
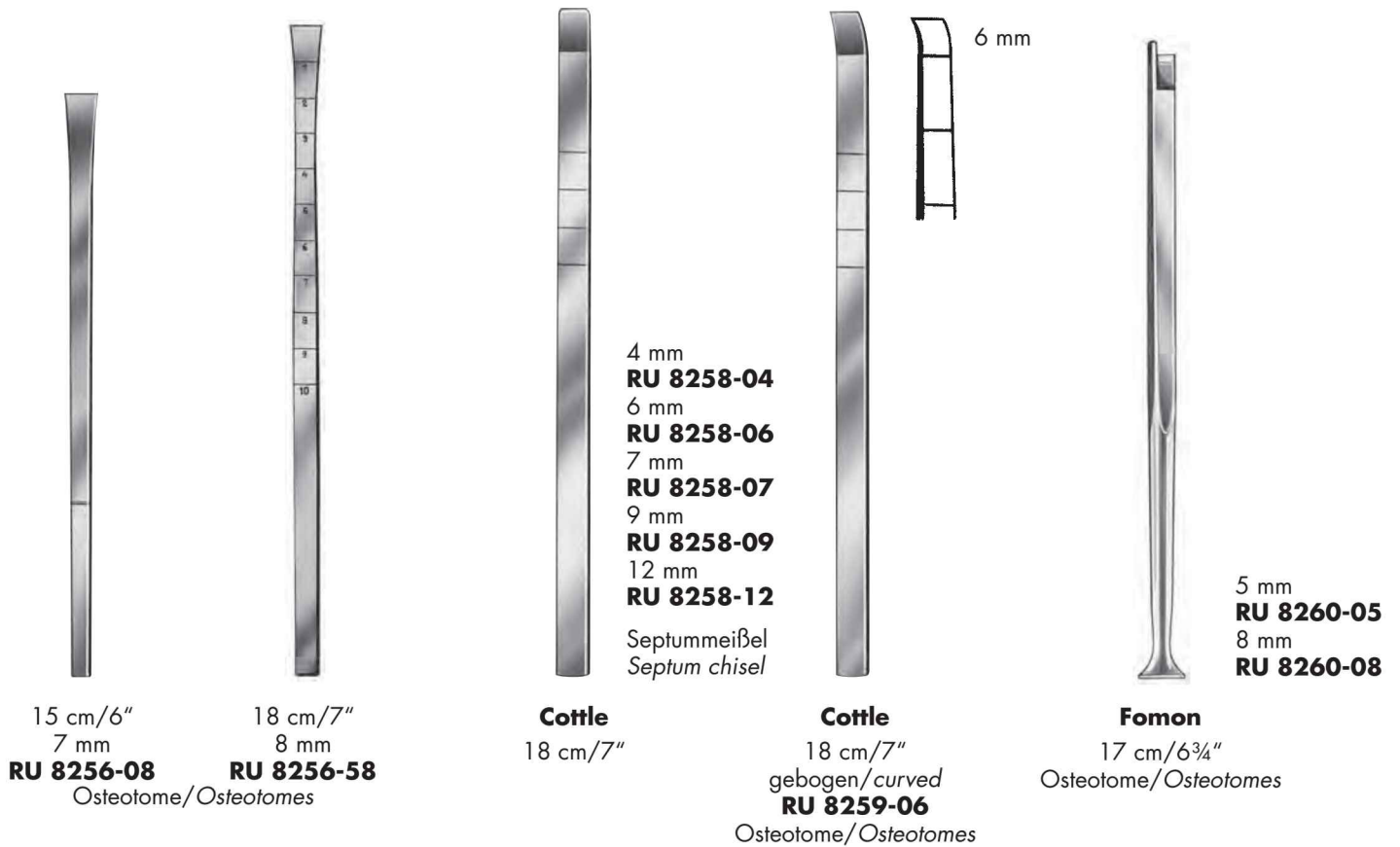

**OSTEOTOME  
OSTEOTOMES**

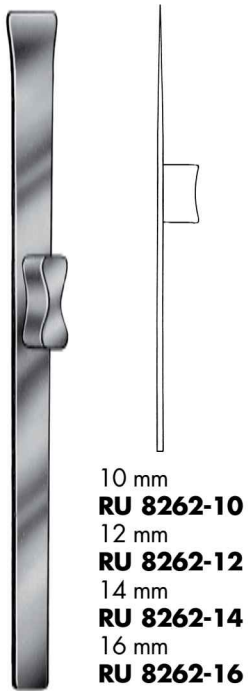

10 mm  
**RU 8262-10**  
12 mm  
**RU 8262-12**  
14 mm  
**RU 8262-14**  
16 mm  
**RU 8262-16**

**Rubin**  
18 cm/7"

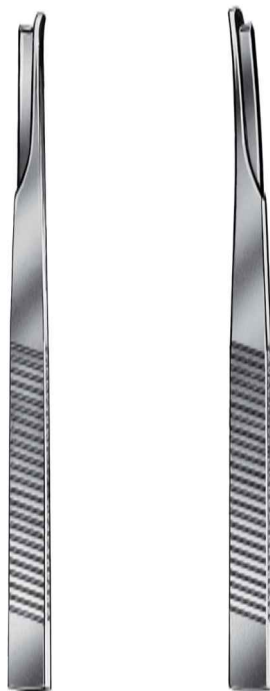

**(Silver)  
Masing**  
17,5 cm/6 7/8"  
**RU 8263-02**

**RU 8263-01**

**RU 8263-03**



links  
left

rechts  
right

**RU 8263-21**

**RU 8263-22**

**Neivert**  
20,5 cm/8 1/4"  
gerade/straight  
**RU 8263-20**

Osteotome/Osteotomes



**Guastella-Ey**  
18 cm/7"

**RU 8263-31**

**RU 8263-32**

3 mm



**RU 8263-40**

3 mm



**Würzburger Modell**

18 cm/7"  
links/left  
**RU 8263-41**

3 mm



rechts/right  
**RU 8263-42**

Osteotome/Osteotomes

**OSTEOTOME, HOHLMEISSEL, HÄMMER**  
**OSTEOTOMES, GOUGES, MALLETS**



**Cinelli**

16 cm/6¼"  
Osteotome/Osteotomes

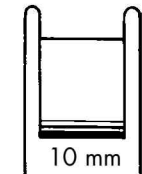

**RU 8264-10**

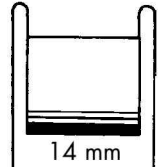

**RU 8264-14**

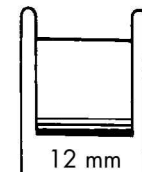

**RU 8264-12**

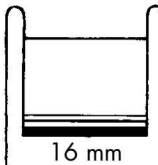

**RU 8264-16**



**Mc Indoe**

14,5 cm/5¾"  
Hohlmeißel/Gouges



11 mm

**RU 8264-81**



13 mm

**RU 8264-83**



15 mm

**RU 8264-85**



6,5 mm

**Parkes**

18 cm/7"  
**RU 8264-65**  
Höcker-Hohlmeißel  
Hump-gouges



10 mm

**Masing**

17,5 cm/6⅞"  
**RU 8265-00**  
Osteotome/Osteotomes



Ersatzbackenpaar  
Pair of spare jaws

**RU 5799-51**

18 cm/7"  
Ø 25 mm/140 g  
**RU 5799-18**



**Cottle**

19 cm/7½"  
Ø 30 mm/350 g  
1 Seite flach/1 Seite konvex  
1 side flat/1 side convex  
**RU 5809-19**

**NASENSÄGEN  
NASAL SAWS**



**Lindemann**  
20 cm/8"  
**RU 8266-20**



**Joseph**  
17 cm/6¾"



**RU 8267-00**

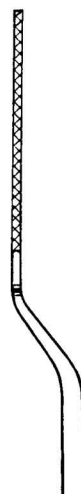

**RU 8267-01**



**RU 8267-02**

**NASENRASPELN  
NASAL RASPS**

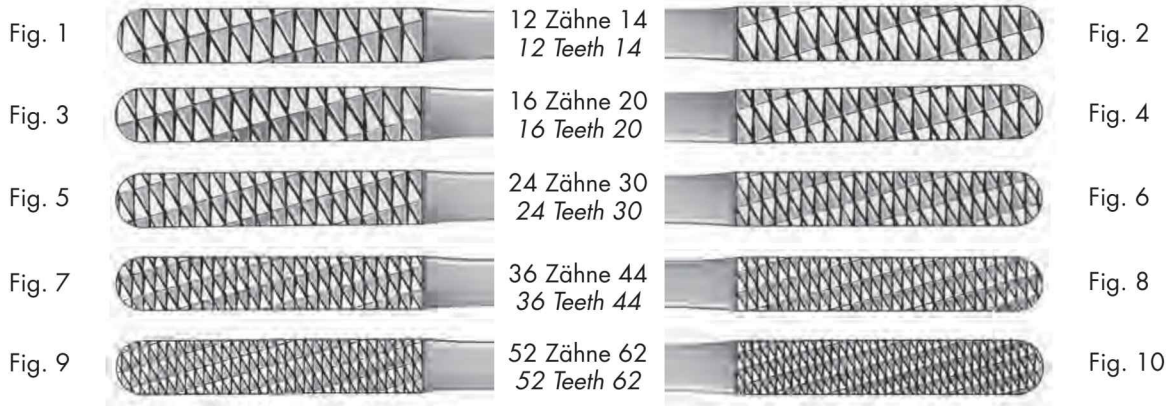

**Fomon**  
21 cm/8¼"



feines Modell  
*delicate Pattern*

	Zähne Teeth		
Fig. 1/2	12/14	<b>RU 8268-01/12</b>	<b>RU 8268-02/12</b>
Fig. 3/4	16/20	<b>RU 8268-01/34</b>	<b>RU 8268-02/34</b>
Fig. 5/6	24/30	<b>RU 8268-01/56</b>	<b>RU 8268-02/56</b>
Fig. 7/8	36/44	<b>RU 8268-01/78</b>	<b>RU 8268-02/78</b>
Fig. 9/10	52/62	<b>RU 8268-01/99</b>	<b>RU 8268-02/99</b>



**Parkes**  
21 cm/8¼"      **Maltz**  
17 cm/6¾"

	<b>Parkes</b>	<b>Maltz</b>
Fig. 1	<b>RU 8268-05/01</b>	<b>RU 8268-07/01</b>
Fig. 2	<b>RU 8268-05/02</b>	<b>RU 8268-07/02</b>
Fig. 3	<b>RU 8268-05/03</b>	<b>RU 8268-07/03</b>
Fig. 4	<b>RU 8268-05/04</b>	<b>RU 8268-07/04</b>
Fig. 5	<b>RU 8268-05/05</b>	<b>RU 8268-07/05</b>
Fig. 6	<b>RU 8268-05/06</b>	<b>RU 8268-07/06</b>
Fig. 7	<b>RU 8268-05/07</b>	<b>RU 8268-07/07</b>
Fig. 8	<b>RU 8268-05/08</b>	<b>RU 8268-07/08</b>
Fig. 9	<b>RU 8268-05/09</b>	<b>RU 8268-07/09</b>
Fig. 10	<b>RU 8268-05/10</b>	<b>RU 8268-07/10</b>

**NASENRASPELN  
NASAL RASPS**



**Maltz**

17,5 cm/6¾"



**RU 8268-10/01**



**RU 8268-10/02**

**Rudolf**<sup>®</sup>  
Tc



12 x 5 mm

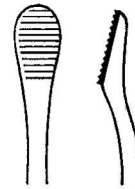

**RU 8268-12/01**

12 x 5 mm

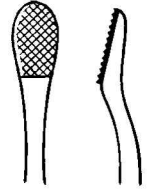

**RU 8268-12/02**

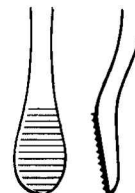

7 x 15 mm

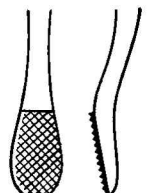

7 x 15 mm

**Miller**

19 cm/7½"

**Diamantaufgabe/diamond jaw**



19 cm/7½"



**RU 8272-02**



**RU 8272-03**



**RU 8272-04**



**RU 8272-05**



**RU 8272-06**



**RU 8272-07**



**Aufricht**

20,5 cm/8⅜"  
**RU 8273-17**



**Fomon**

21 cm/8¼"  
**RU 8276-21**

**NASENRASPELN  
NASAL RASPS**



**Miller**  
18 cm/7"  
**RU 5374-01**



**Miller**  
18 cm/7"  
**RU 5374-02**



**Miller**  
18 cm/7"  
**RU 5374-03**



**Maltz**  
18 cm/7"  
**RU 8270-18**



**Joseph**  
16 cm/6¼"



**RU 8271-01**



**RU 8271-02**



**NASENRASPELN  
NASAL RASPS**



**Lewis**  
18 cm/7"



fein  
fine

**RU 8273-01**



grob  
coarse

**RU 8273-02**



**Cottle**  
21 cm/8¼"  
**RU 8274-21**

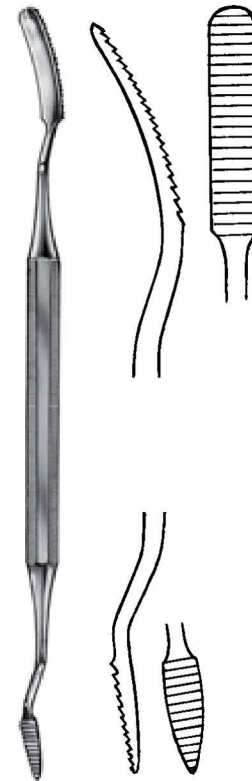

20,5 cm/8¼"  
auf Zug schneidend  
downwards stroke  
**RU 8274-50**



**Aufricht**  
21 cm/8¼"

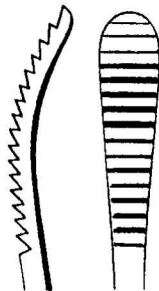

**RU 8275-01**

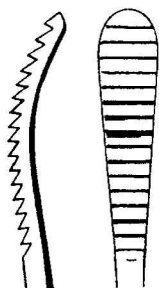

**RU 8275-02**

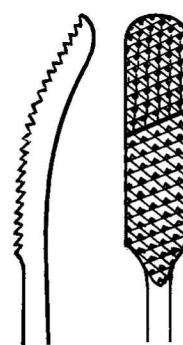

**Aufricht**  
21 cm/8¼"  
auf Druck und Zug schneidend  
upwards and downwards stroke  
**RU 8275-50**  
Glabella-Raspel  
Glabella rasp

**NASENRASPELN, KNOCHEN-KNORPELQUETSCHER, METALLTABLETT  
NASAL RASPS, BONE CRUSHER, PREPARATION TRAY**



**Fomon**  
21 cm/8¼"  
**RU 8276-01 RU 8276-02**



**Kleinert-Kutz  
(Fomon)**  
21 cm/9"  
**RU 8276-50**  
doppelendig, vierseitig  
mit je 2 Seiten fein (flach) und grob (konvex)  
*double-ended, 4-sided*  
*each of 2 sides fine (flat) and coarse (convex)*



**Gallaher**  
18 cm/7"  
**RU 8277-01**

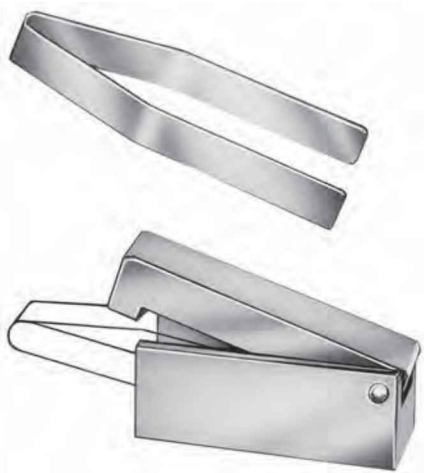

**RU 8278-00**  
Knochen-Knorpelquetscher  
*Bone crusher*



92 x 54 mm  
**RU 7908-24/01**  
Präpariertablett aus Metall  
*Preparation tray of metal*

**HÄKCHEN, ZIRKEL  
HOOKS, CALIPER**



**Gillies**  
18 cm/7"  
**RU 6296-01**



**Gillies**  
18 cm/7"  
**RU 6296-02**



**Kilner**  
15 cm/6"  
**RU 6297-15**



**Frazier**  
13 cm/5"  
18 cm/7"  
**RU 6392-13**  
**RU 6392-18**

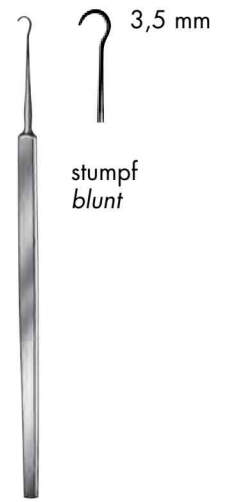

**RU 6393-13**  
**RU 6393-18**



**Knapp**  
13 cm/5"  
**RU 9405-13**



**Rollet**  
13 cm/5"  
**RU 9406-13**



16 cm/6¼"



**Graefe**  
**RU 4430-03/01** **RU 4430-03/02**

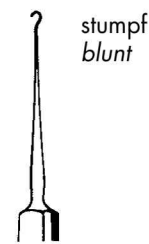

**Castroviejo**  
**RU 9610-15**  
Meßbereich: 15 mm  
Measuring range: 15 mm

**HÄKCHEN, GEWEBEKRALLE, FADENGABEL**  
**HOOKS, TISSUE PICK, SUTURE PUSHER AND KNOT TIER**



18,5 cm/7¼"  
90° abgewinkelt  
90° angled  
**RU 8822-06**



**Yasargil**  
18,5 cm/7¼"  
**RU 8826-00**



**Yasargil**  
18,5 cm/7¼"  
**RU 8826-01**



**Yasargil**  
18,5 cm/7¼"  
**RU 8826-02**



**Yasargil**  
18,5 cm/7¼"  
**RU 8826-03**

Fadenführer geknüpft  
*Ligature guides, probe pointed*



1,0 mm



1,8 mm



18,5 cm/7¼"  
**RU 8835-13**  
Fadengabel  
*Suture pusher*  
*and knot tier*

18,5 cm/7¼"  
1,0 mm **RU 8831-10**  
1,8 mm **RU 8831-18**  
Gewebekralle  
*Tissue Pick*

**HÄKCHEN  
HOOKS**



**Cottle**  
16 cm/6¼"  
**RU 8281-16**



180°  
retrograd  
gebogen  
retrograde  
curved

**Cottle**  
16 cm/6¼"  
**RU 8282-03**



schwarz  
black finish

**RU 8283-01**

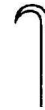

**RU 8283-02**



**RU 8283-03**

14,5 cm/5½"

schwarz  
black finish

**RU 8283-01 B**

**RU 8283-02 B**

**RU 8283-03 B**



90°

16,5 cm/6"  
**RU 8283-04**



**Cottle**  
15 cm/6"  
**RU 8284-01**



**Lange**  
22 cm/8¾"  
**RU 8286-22**



**Fraenkel-Neivert**  
20,5 cm/8"  
**RU 8286-52**

RU 8280-15 entnehmen Sie bitte Seite 312  
For RU 8280-15 please refer to page 312

**HÄKCHEN  
HOOKS**



**Fomon**  
17 cm/6¾"  
RU 8287-17



**Müller**  
15 cm/6"  
RU 8288-01



**Müller**  
15 cm/6"  
RU 8288-02



**Freer**  
15 cm/6"  
RU 8290-15



**Joseph**  
15 cm/6"  
RU 8280-15



**Joseph**  
16 cm/6¼"



2 mm  
RU 8292-02



5 mm  
RU 8292-05



7 mm  
RU 8292-07



10 mm  
RU 8292-10

**HÄKCHEN  
HOOKS**



9 mm  
**RU 8293-09**

**Mc Indoe**  
15 cm/6"  
**RU 8293-09**



10 mm  
**RU 8293-10**



**Fomon**  
16 cm/6¼"  
**RU 8294-16**



**Neivert (Masing)**  
20 cm/8"  
**RU 8298-20**



10 mm  
**Neivert**  
19,5 cm/7¾"  
**RU 8299-19**



**Cottle-Neivert**  
20 cm/8"  
**RU 8299-20**



**Cottle**  
14,5 cm/5¾"  
**RU 8300-14**



**Fomon**  
14,5 cm/5¾"  
**RU 8300-14/01**

**NASENFLÜGELHAKEN  
ALAR RETRACTORS**



**Cottle**  
14,5 cm/5¾"  
**RU 8301-01**



**Cottle**  
14,5 cm/5¾"  
**RU 8301-02**

10 x 12 mm



**Cottle**  
15 cm/6"  
**RU 8302-15**

13 x 24 mm



**Cottle**  
16 cm/6¼"  
**RU 8302-30**

6 x 12 mm



**Masing**  
14 cm/5½"  
**RU 8302-31**

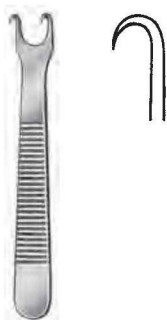

**Kilner**  
8 cm/3⅛"  
scharf/sharp  
10 mm **RU 8303-08**  
13 mm **RU 8303-09**  
stumpf/blunt  
10 mm **RU 8303-18**  
13 mm **RU 8303-19**

10 mm



**Cottle**  
5,5 cm/2¼"  
**RU 8303-30**



**Converse**  
12 cm/4¾"  
**RU 8304-12**



**Aufricht**  
16 cm/6¼"  
8 x 45 mm **RU 8310-16**  
8 x 60 mm **RU 8310-60**



**Cottle**  
10 cm/4"  
**RU 8312-10**



**NASENHAKEN  
NASAL RETRACTORS**



**Cottle**

14 cm/5½"  
Satz zu 4 Stück – Set/4 sizes:  
**RU 8315-00**

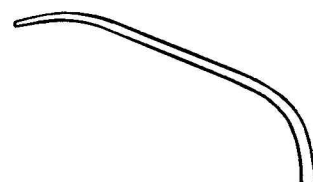

40 mm  
**RU 8315-01**

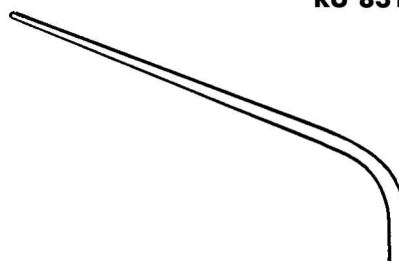

50 mm  
**RU 8315-02**

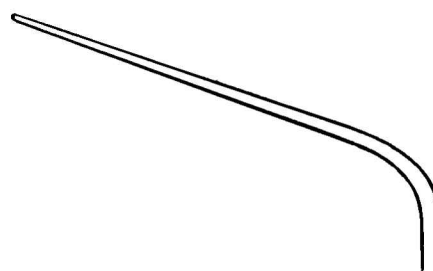

55 mm  
**RU 8315-03**

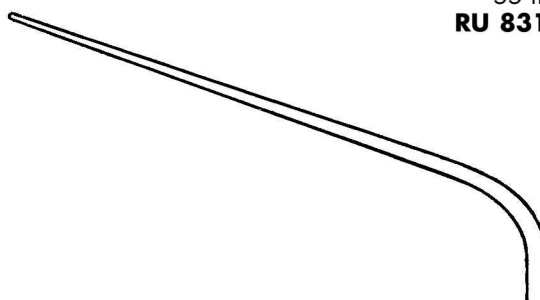

70 mm  
**RU 8315-04**

**HAKEN, NASENFRAKTURAUFRICHTER  
HOOKS, SEPTUM ELEVATORS**

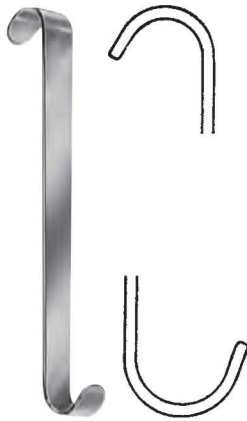

**Luer**  
11 cm/4½"  
**RU 4479-11**



**Senn-Miller**  
16 cm/6¼"



**Ragnell-Davis**  
15 cm/6"  
**RU 4488-14**



**Walter**  
13 cm/5"  
**RU 8316-12**



**Boies**  
18 cm/7"  
**RU 8326-01**



**Goldmann**  
20 cm/8"  
**RU 8326-02**

**REPOSITIONSZANGEN, SEPTUMRICHTZANGEN  
REPOSITION FORCEPS, SEPTUM STRAIGHTENING FORCEPS**



**Rowe**  
23 cm/9"

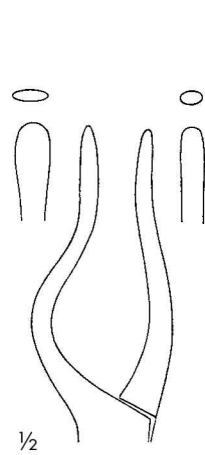

**Fig.1**

für die linke Seite  
for the left side

**RU 8327-01**

für die rechte Seite  
for the right side

**RU 8327-11**

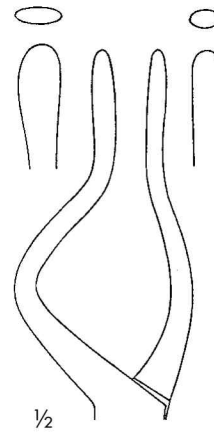

**Fig.2**

**RU 8327-02**

**RU 8327-12**

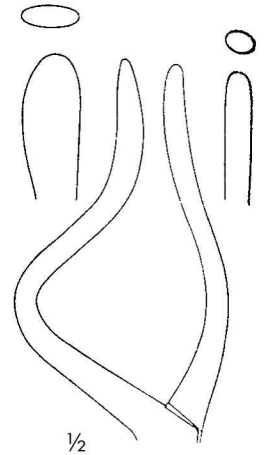

**Fig.3**

**RU 8327-03**

**RU 8327-13**



**Walsham**  
23 cm/9"



**RU 8328-01**

rechts und links  
verwendbar  
applicable for  
left and right



**RU 8328-02**

rechts  
right



**RU 8328-03**

links  
left



**Cottle-Walsham**  
22 cm/8¾"  
zerlegbar/detachable  
**RU 8329-22**

**SEPTUMRICHTZANGEN**  
**SEPTUM STRAIGHTENING FORCEPS**



**Asch**  
23 cm/9"  
abgewinkelt/angular  
**RU 8330-23**



**Kressner**  
20 cm/8"  
3 mm **RU 8331-20**  
4 mm **RU 8331-21**



**Rubin**  
20 cm/8"  
**RU 8333-20**



**RU 8333-50**  
Schutzkappe alleine  
Protecting cap only