

OTOLOGIE OHR-MIKROCHIRURGIE

OTOLOGY EAR MICRO SURGERY

Seiten 161 - 242

Pages 161 - 242



Übersicht

Scheren, Pinzetten
Wundsperrer, Spreizer
Ohrsonden, Watteträger
Nystagmus-Brillen, Zubehör
Meißel, Osteotome, Stößel
Löffel, Raspatorien
Zangen, Hämmer, Stanzen
Ohrspekulas, Sets, Zubehör
Stimmgabeln, Sets, Lärrtrommeln
Saugrohre, -adapter, -instrumente
Polypenschnürer, -schlingen
Ohr-, Löffel-, Drahtbiegezangen
Micro-Instrumente, OP-Gestell, Schutzhülse
Tubeninstrumentarium, (Paukenröhrchen)
Mikrozangen, -scheren, -stanzen
Mikrochirurg, Besteck, Skalpelle, Messer
Nadeln, Häkchen
Diverses Instrumentarium
Küretten, Löffel, Schlingen

General View

Scissors, forceps
Retractors, spreader
Ear probes, applicators
Nystagmus spectacles, accessories
Chisels, gouges, osteotomes, pestles
Bone curettes, raspatories
Forceps, mallets, punches
Ear speculas, sets, accessories
Tuning forks, sets, noise apparatus
Suction tubes, adapters, -instruments
Polypus snares, -loops
Ear-, cup-shaped and wire bending forceps
Micro instruments, OP-rack, protect sleeve
Tube instrumentation
Micro forceps, -scissors, -nippers
Micro surgery sets, scalpels, knives
Needles, hooks
Various instruments
Curettes, spoons, loops

Seiten / Pages

162-166
167-169
170-171
172
173-174
175-178
179-184
185-190
191-194
195-198
199
200-207, 219
208
209-216
217-221, 205, 207
222-225, 238-239
226-228, 238, 239
229-235, 240-242
236-237

**SCHEREN
SCISSORS**

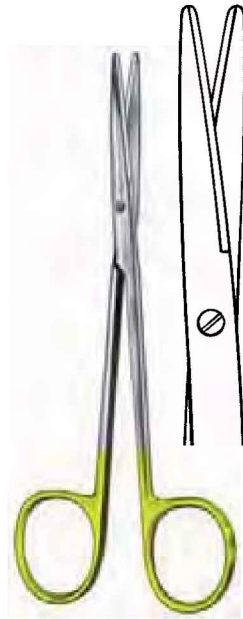

Rudolf[®]
TC



Metzenbaum
14,5 cm/5½"
gerade/straight
RU 1304-14

Metzenbaum-Fino
14,5 cm/5½"
gerade/straight
RU 1306-14

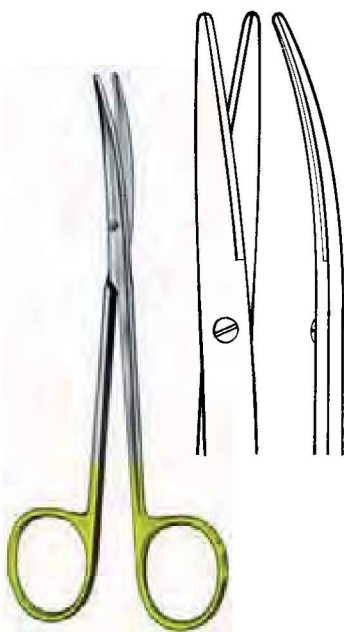

Rudolf[®]
TC



Metzenbaum
14,5 cm/5½"
gebogen/curved
RU 1314-14

Metzenbaum-Fino
14,5 cm/5½"
gebogen/curved
RU 1316-14



Joseph
14 cm/5¼"
gerade/straight
RU 1670-14



Joseph
14 cm/5¼"
gebogen/curved
RU 1671-14

**SCHEREN
SCISSORS**



Gorney
12,5 cm/5"
gerade, gezahnt
straight, serrated
RU 1688-12 MC



Gorney
12,5 cm/5"
gebogen, gezahnt
curved, serrated
RU 1689-12 MC



15 cm/6"
RU 1792-15



Millesi
16 cm/6¼"
gerade, gezahnt
straight, serrated
RU 2376-16



Millesi
16 cm/6¼"
gebogen, gezahnt
curved, serrated
RU 2377-16

**SCHEREN
SCISSORS**



	Fino gerade/straight	Fino gebogen/curved
9,5 cm/3¾"	RU 2422-09	RU 2423-09
10,5 cm/4¼"	RU 2422-10	RU 2423-10
11,5 cm/4½"	RU 2422-11	RU 2423-11



11,5 cm/4½"
gerade/straight
RU 2462-11

11,5 cm/4½"
gebogen/curved
RU 2463-11

Schuhknecht
10 cm/4"
gezahnt/saw edge
RU 2615-10

PINZETTEN
DRESSING AND TISSUE FORCEPS



Semken
12 cm/5"
RU 4040-12



Semken
15 cm/6"
RU 4040-15



Lazar
15,5 cm/6"

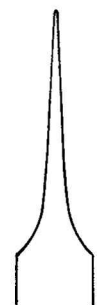

0,5 mm

RU 4075-05

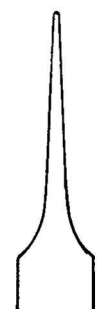

0,8 mm

RU 4075-08



Derlacki
12 cm/4¾"
RU 4143-12



No. 5
11,5 cm/4½"
RU 4240-05

OHRPINZETTEN
EAR DRESSING AND TISSUE FORCEPS

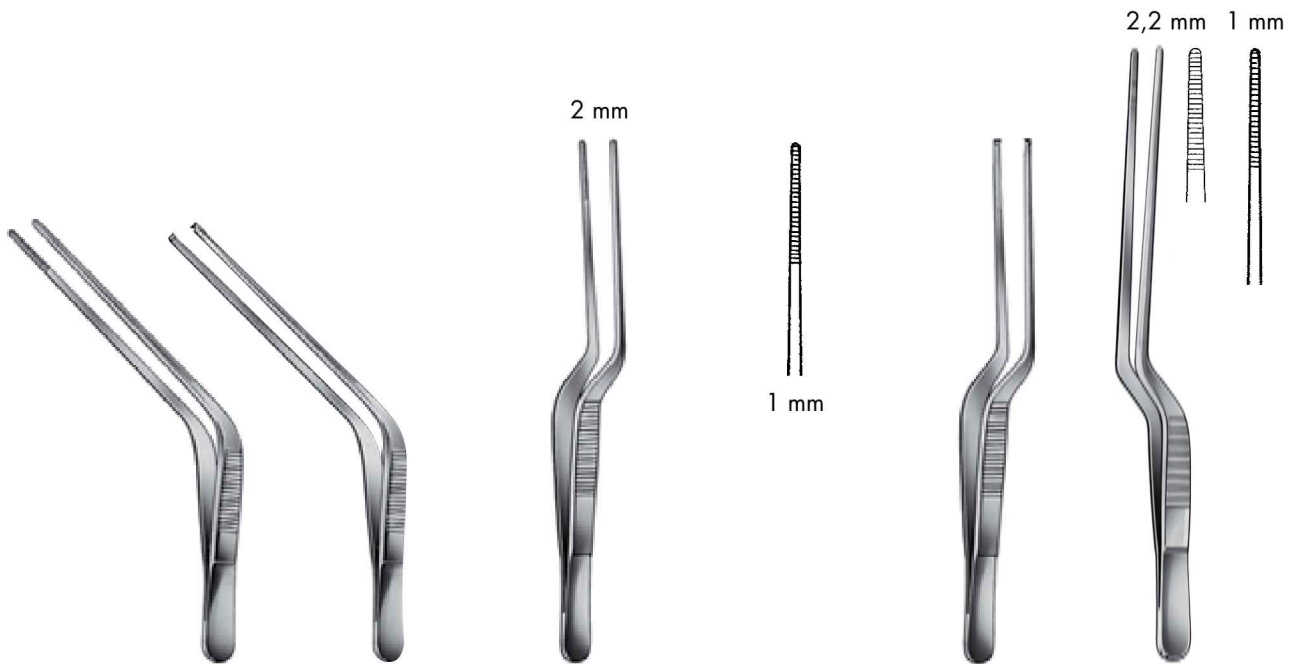

cm	in	Troeltsch (Wilde)	Troeltsch	Lucae	Lucae	Jansen (Gruenwald)
11	4½	RU 7860-11				
12	4¾	RU 7860-12	RU 7861-12			
14	5½			RU 7862-14	RU 7862-14/1	RU 7863-14
15	6	RU 7860-15				
16	6¼					RU 7864-16 RU 7864-16/1
18	7	RU 7860-18				RU 7864-18 RU 7864-18/1
20	8					RU 7864-20 RU 7864-20/1



Jansen

16 cm/6¼"
RU 7865-16
18 cm/7"
RU 7865-20



Troeltsch
12 cm/4¾"
selbstschließend
cross action
RU 7866-12



Williger

12 cm/4¾"

links gebogen
left curved

gerade
straight

rechts gebogen
right curved

RU 4472-25

RU 4472-24

RU 4472-26



Allport

9,5 cm/3¾"

RU 4645-09



Jansen

10,5 cm/4¼"

scharf/sharp stumpf/blunt
RU 4680-10 RU 4681-10



Jansen-Deep

10,5 cm/4¼"

scharf/sharp stumpf/blunt
RU 4684-10 RU 4685-10

**WUNDSPERRER
RETRACTORS**



Plester
11 cm/4½"
RU 4690-01



Plester-Helms
11 cm/4½"
RU 4689-01

volles Blatt mit
atraumatischer Zahnung
*Blade with
atraumatic teeth*



Plester
11 cm/4½"
RU 4690-02



Plester-Helms
11 cm/4½"
RU 4689-02

volles Blatt mit
atraumatischer Zahnung
*Blade with
atraumatic teeth*



Plester
13 cm/5"
scharf/sharp stumpf/blunt
RU 4691-01 RU 4691-02

**WUNDSPERRER
RETRACTORS**



Weitlaner

scharf/sharp stumpf/blunt



Weitlaner-Wullstein

scharf/sharp stumpf/blunt



Bellucci

10,5 cm/4¼"

13 cm/5

16,5 cm/6½"

RU 4700-13

RU 4701-13

RU 4710-13

RU 4711-13

RU 4713-13

RU 4700-16

RU 4701-16

RU 4710-16

RU 4711-16



Fisch

17 cm/6¾"
RU 4736-17

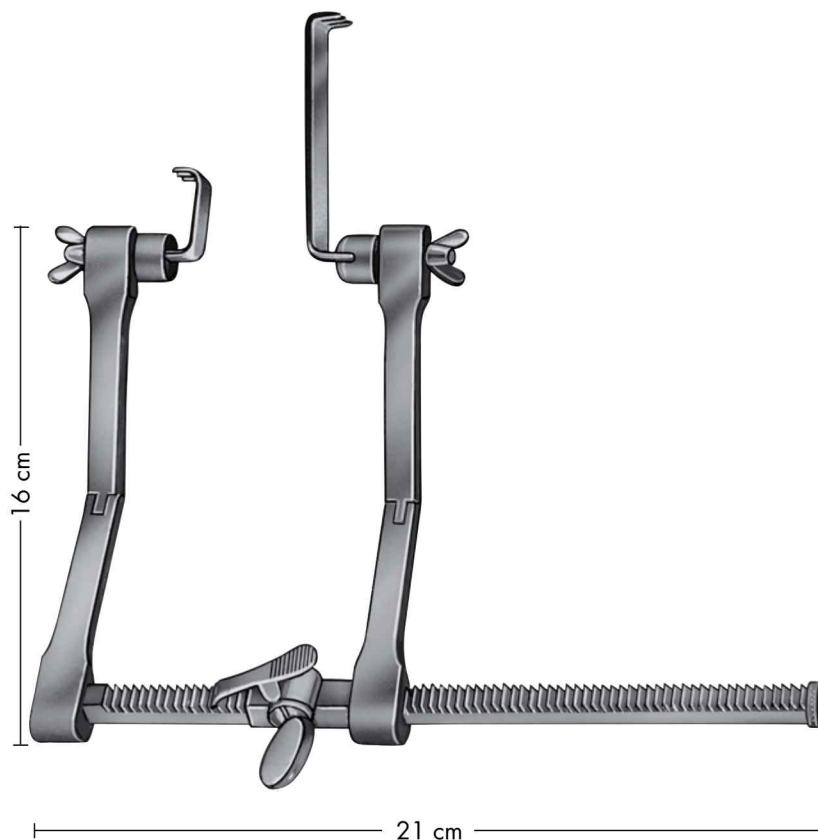

RU 4784-00

Glomus-Spreizer
Glomus spreader

**OHRSONDEN
EAR PROBES**



Stacke
10,5 cm/4¼"
Ø 1,0 mm
RU 4916-10



Stacke-Frenzel
9 cm/3½"
RU 4916-10/01



Kley
26 cm/10¼"
RU 4919-26



28 cm/10¾"
RU 4919-26/01

Schutzhülse zu RU 4919-26
Protective shield for RU 4919-26



Seiffert
18 cm/7"
Ø 0,5 mm
RU 4924-18

**WATTETRÄGER
APPLICATORS**



Buck

12 cm/4¾"
Ø 0,9 mm

RU 4927-12



Piccolo

11 cm/4½"
Ø 0,7 mm
rund/round

RU 4928-01/11



Piccolo

11 cm/4½"
Ø 0,7 mm
dreikant/triangular

RU 4928-02/11



Universal

cm/in	Ø 1,2 mm	Ø 1,5 mm	Ø 1,7 mm
12,5/5	RU 4930-12		RU 4932-12
16/6¼	RU 4930-16		RU 4932-16
18/7		RU 4931-18	RU 4932-18



Jobson-Horne
18 cm/7"
RU 4933-02/18



**Farell
(Farell-Lathbury)**

cm/in	Ø	rund round	dreikant triangular
14/5½	0,9 mm	RU 4935-14	RU 4936-14
16/6¼	1,1 mm	RU 4935-16	RU 4936-16

NYSTAGMUS-BRILLEN NYSTAGMUS SPECTACLES

Nystagmus-Brillen nach Prof. Frenzel Nystagmus Spectacles by Prof. Frenzel

- | | | |
|-------------------|--|---|
| RU 5140-11 | - mit festen Gläsern
- festem Anschlußkabel
- Clip-Kopfband | - <i>fixed lenses</i>
- <i>fixed connection wire</i>
- <i>Clip head strap</i> |
| RU 5140-00 | - mit klappbaren Gläsern
- festem Anschlußkabel
- Kopfband | - <i>hinged lenses</i>
- <i>fixed connection wire</i>
- <i>fixed head strap</i> |
| RU 5140-22 | - mit festen Gläsern
- festem regelbaren Batteriegriff, oben | - <i>fixed lenses</i>
- <i>adjustable battery hold</i> |
| RU 5140-23 | - mit seitlichem Bajonetverschluss
- festen Gläsern
- regelbarem Batteriegriff | - <i>bajonet interlocking</i>
- <i>fixed lenses</i>
- <i>adjustable battery hold universal applicable</i> |



Zubehör/accessories

- | | |
|-------------------|---|
| RU 5140-40 | Bajonetkabel, Verbindung Brille - Batteriegriff, <i>Bajonet wire</i> |
| RU 5140-41 | Anschlußkabel, Brille zu Spannungsquellen
<i>Connection wire for power sources</i> |
| RU 5140-42 | Clipkopfband, schwarz
<i>Clip Head strap</i> |

Nystagmus-Brillen nach Blessing Nystagmus Spectacles by Blessing

- | | | |
|-------------------|--|---|
| RU 5141-11 | - mit festen Gläsern
- festem Anschlußkabel
- Clip-Kopfband | - <i>fixed lenses</i>
- <i>fixed connection wire</i>
- <i>Clip head strap</i> |
| RU 5141-00 | - mit klappbaren Gläsern
- festem Anschlußkabel
- Kopfband | - <i>hinged lenses</i>
- <i>fixed connection wire</i>
- <i>fixed head strap</i> |
| RU 5141-12 | - mit festen Gläsern
- festem regelbaren Batteriegriff, oben | - <i>fixed lenses</i>
- <i>adjustable battery hold</i> |
| RU 5140-23 | - mit seitlichem Bajonetverschluss
- festen Gläsern
- regelbarem Batteriegriff | - <i>bajonet interlocking</i>
- <i>fixed lenses</i>
- <i>adjustable battery hold universal applicable</i> |



Zubehör/accessories

- | | |
|-------------------|--|
| RU 5141-40 | Bajonetkabel, Verbindung Brille - Batteriegriff, <i>Bajonet wire</i> |
| RU 5141-41 | Anschlußkabel, Brille zu Spannungsquellen,
<i>Connection wire for power sources</i> |
| RU 5141-42 | Clipkopfband, schwarz
<i>Clip Head strap</i> |

RU 5140-70

Batteriegehäuse
gewährleistet die Stromversorgung der Nystagmus-Brille über 3 Babyzellen á 1,5 V und ermöglicht so (Stromnetz-) unabhängiges Arbeiten
Batterien nicht im Lieferumfang



In order to allow a usage independent of the power supply, alternatively the Nystagmus Spectacle can be supplied with power through the Battery container. It can be operated with three 1.5 Volt batteries, size C LR14/AM-2 (baby cells). (Batteries are not subject of the offer).



RU 5140-50 **Ersatzlampe**

für alle Nystagmus-Brillen,
4 V, 0,23 Ampere, 1 Watt

Replacement lamp

The Nystagmus Spectacle can be operated with a 4 Volt; 0.23 Ampere; 1 Watt

Weitere Spannungsquellen auf Seite 124
further power sources page 124

**FLACH- UND HOHLMEISSEL, OSTEOTOME
CHISELS, GOUGES AND OSTEOTOMES**

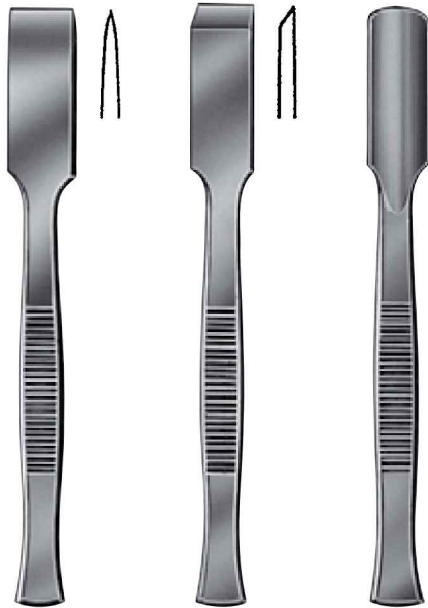

Breite/
width

13,5 cm/5¼"

4 mm	RU 5300-04	RU 5302-04	RU 5304-04
6 mm	RU 5300-06	RU 5302-06	RU 5304-06
8 mm	RU 5300-08	RU 5302-08	RU 5304-08
10 mm	RU 5300-10	RU 5302-10	RU 5304-10
12 mm	RU 5300-12	RU 5302-12	RU 5304-12

Osteotome
Osteotomes

Flachmeißel
Chisels

Hohlmeißel
Gouges



Lucas
16 cm/6¼"

3 mm	RU 5305-01/03	RU 5305-02/03
4 mm	RU 5305-01/04	RU 5305-02/04
5 mm	RU 5305-01/05	RU 5305-02/05
6 mm	RU 5305-01/06	RU 5305-02/06

Flachmeißel
Chisels

Hohlmeißel
Gouges



Partsch

13,5 cm/5¼"

mm

Partsch

13,5 cm/5¼"

RU 5308-02	2
RU 5308-03	3
RU 5308-05	5
RU 5308-07	7
RU 5308-08	8

Flachmeißel
Chisels

RU 5314-02	2
RU 5314-03	3
RU 5314-05	5
RU 5314-07	7
RU 5314-08	8

Hohlmeißel
Gouges



3 mm
RU 5309-03

4 mm
RU 5309-04

Thies

16 cm/6¼"

Flachmeißel
Chisels



3 mm
RU 5315-03

4 mm
RU 5315-04

Thies

16 cm/6¼"

Hohlmeißel
Gouges

**STÖSSEL UND MEISSEL
PESTLES AND CHISELS**



16 cm/6¼"

○ 3 mm
RU 5317-03

○ 5 mm
RU 5317-05

○ 7 mm
RU 5317-07

○ 9 mm
RU 5317-09



Passow
12 cm/4¾"

■ 2,5 mm
RU 5318-02

■ 3,5 mm
RU 5318-03



Mini-Lexer

18 cm/7"

mm

RU 5334-04	4	RU 5335-04
RU 5334-06	6	RU 5335-06
RU 5334-08	8	RU 5335-08
RU 5334-10	10	RU 5335-10
RU 5334-12	12	RU 5335-12

Osteotom
Osteotome

Hohlmeißel
Gouges



**SCHARFE LÖFFEL
BONE CURETTES**



Volkman
17 cm/6¾"

- | | |
|------|-------------------|
| Fig. | |
| 0000 | RU 5350-40 |
| 000 | RU 5350-30 |
| 00 | RU 5350-20 |
| 0 | RU 5350-10 |
| 1 | RU 5350-01 |
| 2 | RU 5350-02 |
| 3 | RU 5350-03 |
| 4 | RU 5350-04 |
| 5 | RU 5350-05 |
| 6 | RU 5350-06 |

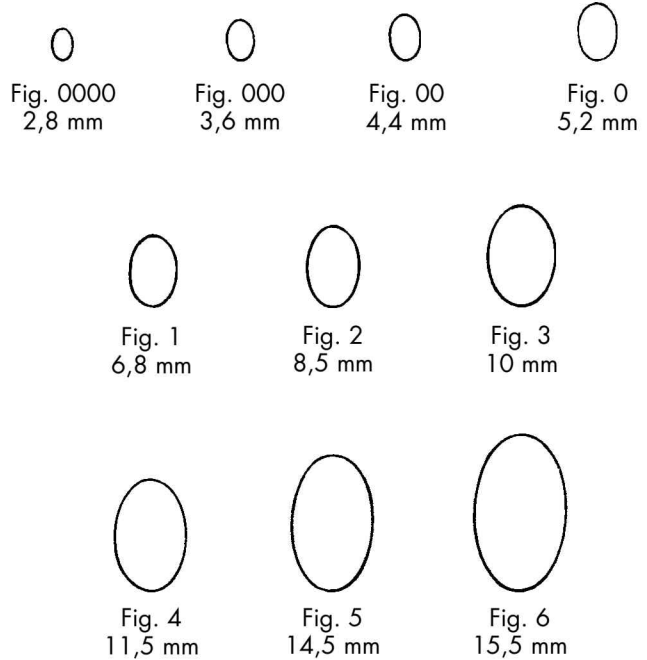

Lempert
21,5 cm/8½"

- | | |
|---|-------------------|
|  | |
| 3,0 mm | RU 7993-10 |
|  | |
| 2,7 mm | RU 7993-20 |
|  | |
| 2,4 mm | RU 7993-30 |
|  | |
| 2,0 mm | RU 7993-40 |
|  | |
| 1,7 mm | RU 7993-50 |



Williger
17,5 cm/7"

- | | |
|---|-------------------|
|  | RU 5356-20 |
| Fig. 00 | |
|  | RU 5356-10 |
| Fig. 0 | |
|  | RU 5356-01 |
| Fig. 1 | |
|  | RU 5356-02 |
| Fig. 2 | |

**SCHARFE LÖFFEL
BONE CURETTES**

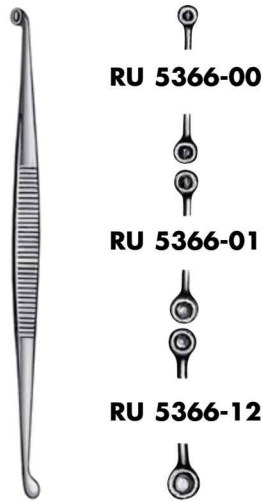

Martini
13,5cm/5"



Jansen
16 cm/6¼"
RU 5367-00/16

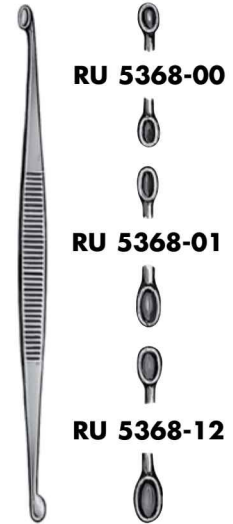

Williger
13,5 cm/5"



Barth-Preysing
19 cm/7½"
RU 5369-00/19



Jacobson
13 cm/5"
RU 5369-13



Miller
18 cm/7"
RU 5370-18

**RASPATORIEN
PERIOSTEAL RASPATORIES**

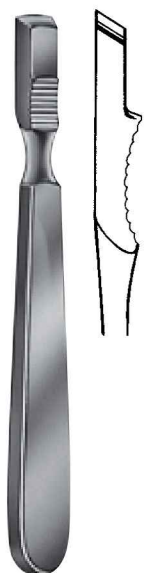

Farabeuf
15 cm/6"
RU 5380-15

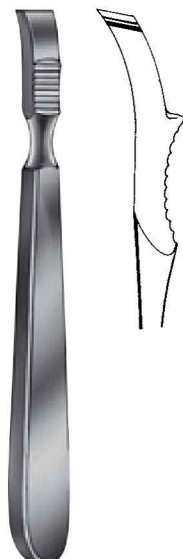

Farabeuf
15 cm/6"
RU 5381-15



Jansen
16,5 cm/6½"
RU 5388-16



17 cm/6¾"
6 mm 8 mm
RU 5394-06 RU 5394-08



19 cm/7½"
RU 5410-01



18,5 cm/7¼"
RU 5410-02



18,5 cm/7¼"
RU 5410-03



18,5 cm/7¼"
RU 5410-04

RASPATORIEN, ELEVATORIEN, PERIOSTMESSER
PERIOSTEAL RASPATORIES, PERIOSTEAL KNIFE

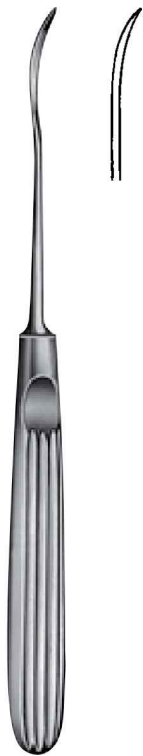

Eicken
Ø 6 mm
19,5 cm/7¾"
RU 5413-06



Jansen
Ø 9 mm
19,5 cm/7¾"
RU 5414-09



Jansen
Ø 14 mm
19,5 cm/7¾"
RU 5414-14

Raspatorien/Raspatories



Quervain
20 cm/8"
RU 5427-20



König
Ø 4,5 mm
15 cm/6"
RU 5431-01



Sebileau
17 cm/6¾"
RU 5436-17



Muck
13,5 cm/5½"
RU 7955-13
Periostmesser
Periosteal Knife

Elevatoren/Elevatories

**HOHLMEISSELZANGEN
BONE RONGEUR FORCEPS**



Friedmann
14 cm/5½"
RU 5560-14



Friedmann-Delikat
15 cm/6"



Lempert

gerade straight		gebogen curved
	cm in	
RU 5570-16	16 6¼	RU 5571-16
RU 5570-19	19 7½	RU 5571-19



Beyer
18 cm/7"
RU 5572-18



Jansen
18 cm/7"
RU 5576-19



Heanley
19 cm/7½"
RU 5578-19

**HOHLMEISSELZANGEN
BONE RONGEUR FORCEPS**

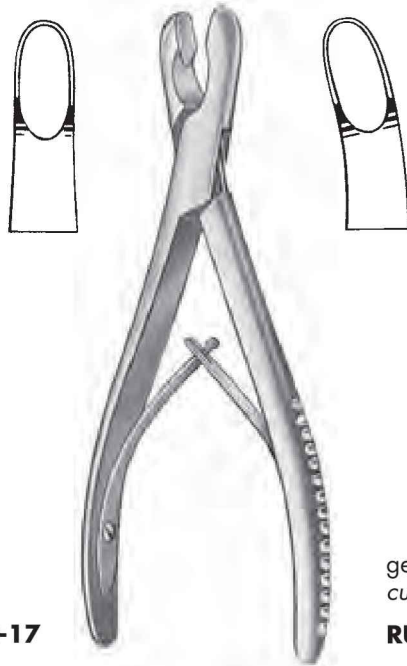

gerade
straight
RU 5580-17

gebogen
curved
RU 5581-17

Luer
17 cm/6¾"



Böhler
15 cm/6"

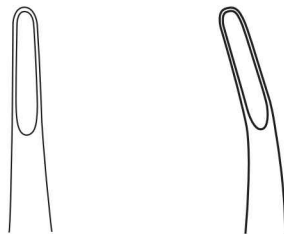

gerade/straight gebogen/curved
RU 5588-15/1 RU 5589-15/1
RU 5588-15 RU 5589-15

3 mm
4 mm



**Beyer
Zaufal-Jansen**
18 cm/7"



**Zaufal-Jansen
RU 5590-18**

**Beyer
RU 5592-18**

**KNOCHENSPLITTERZANGEN
BONE CUTTING FORCEPS**



Cleveland

13 cm/5" **RU 5648-13**
15 cm/6" **RU 5648-15**
17 cm/6¾" **RU 5648-17**



gerade
straight

RU 5700-15

aufgebogen
curved on flat

RU 5701-15

Böhler

15 cm/6"

**HÄMMER
MALLETS**



Ersatzbackenpaar
Pair of spare jaws
RU 5798-51

◀ mit auswechselbaren
Kunststoffbacken
*with interchangeable
plastic jaws* ▶

24,5 cm/9¾"
Ø 30 mm, 215 g
RU 5798-24



Ersatzbackenpaar
Pair of spare jaws
RU 5799-51

18 cm/7"
Ø 25 mm, 140 g
RU 5799-18



Heermann
19,5 cm/7½"
RU 5807-19



Cottle
19 cm/7½"
Ø 30 mm, 250 g
1 Seite flach, 1 Seite konvex
1 side flat, 1 side convex
RU 5809-19

**HÄMMER
MALLETS**



Hajek
22 cm/8¾"
Ø 27 mm, 140 g
RU 5811-23



19 cm/7½"
Ø 22 mm, 165 g
bleigefüllt, *lead filled*
RU 5812-19



Fig. 1
19 mm Ø
RU 5813-01

Fig. 2
25 mm Ø
RU 5813-02



massiv, mit
auswechselbaren
Ferrozellbacken

*solid, with
interchangeable
Ferrozell jaws*
RU 5816-17

Ersatzbackenpaar
Spare jaws, pair
RU 5816-20

Mead
17 cm/6¾"
Ø 26 mm, 320 g

**KNOCHENSTANZEN
EAR PUNCHES**

90° nach oben schneidend



Citelli

Bißbreite 2 mm **RU 7895-20**
Width of bite 3 mm **RU 7895-30**





Beyer

Bißbreite 1,5 mm **RU 7896-15**
Width of bite



Kerrison
20 cm / 8"

-  3,0 mm **RU 8134-03**
-  4,0 mm **RU 8134-04**
-  5,0 mm **RU 8134-05**
-  6,0 mm **RU 8134-06**

**OHRSPKULA
EAR SPECULA**



	I Ø	A Ø	
Fig. 1	1,5 mm	2,5 mm	RU 7800-01
Fig. 2	2,5 mm	3,5 mm	RU 7800-02
Fig. 3	3,5 mm	4,5 mm	RU 7800-03
Satz/Set, Fig. 1-3			RU 7800-10

Trölsch

für Säuglinge und Kinder
for babies and children

verchromt/chromium-plated



	I Ø	A Ø	
Fig. 4	4,0 mm	5,0 mm	RU 7800-04
Fig. 5	5,0 mm	6,0 mm	RU 7800-05
Fig. 6	6,0 mm	7,0 mm	RU 7800-06
Fig. 7	7,0 mm	8,0 mm	RU 7800-07
Satz/Set, Fig. 4-6			RU 7800-30
Satz/Set, Fig. 4-7			RU 7800-40

Troeltsch

für Erwachsene
for adults

verchromt/chromium-plated

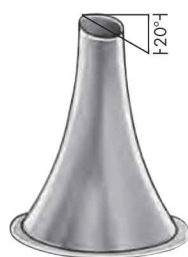

Farrior

oval,
20° abgeschrägt
oval,
20° slanted

rostfrei
stainless steel

		I Ø	A Ø	
○	Fig. 1	3,0 x 4,0 mm	3,8 x 4,8 mm	RU 7801-01 NR
○	Fig. 2	4,0 x 5,0 mm	4,8 x 5,8 mm	RU 7801-02 NR
○	Fig. 3	4,5 x 5,5 mm	5,3 x 6,3 mm	RU 7801-03 NR
○	Fig. 4	5,0 x 6,0 mm	5,8 x 6,8 mm	RU 7801-04 NR
○	Fig. 5	5,5 x 6,5 mm	6,3 x 7,3 mm	RU 7801-05 NR
○	Fig. 6	6,0 x 7,0 mm	6,8 x 7,8 mm	RU 7801-06 NR
○	Fig. 7	6,5 x 7,5 mm	7,3 x 8,3 mm	RU 7801-07 NR
○	Fig. 8	7,0 x 8,0 mm	7,8 x 8,8 mm	RU 7801-08 NR
○	Fig. 9	7,5 x 8,5 mm	8,3 x 9,3 mm	RU 7801-09 NR
Satz/Set, Fig. 1-9				RU 7801-90 NR



Politzer

für Kinder
for children

	I Ø	A Ø	verchromt/ chromium- plated	rostfrei stainless steel
Fig. 1	2,0 mm	3,0 mm	RU 7802-02	RU 7802-02 NR
Fig. 2	3,0 mm	4,0 mm	RU 7802-03	RU 7802-03 NR
Fig. 3	4,0 mm	5,0 mm	RU 7802-04	RU 7802-04 NR
Satz/Set, Fig. 1-3			RU 7802-30	RU 7802-30 NR

I Ø = Innendurchmesser
Inner diameter

A Ø = Außendurchmesser
Outer diameter

**OHRSPKULA
EAR SPECULA**



Erhard

für Erwachsene
for adults

	I Ø	A Ø	
Fig. 1	3,1 mm	4,1 mm	RU 7803-01
Fig. 2	4,3 mm	5,3 mm	RU 7803-02
Fig. 3	5,5 mm	6,5 mm	RU 7803-03
Fig. 4	6,6 mm	7,6 mm	RU 7803-04
	Satz/Set Fig. 1-3		RU 7803-30
	Satz/Set Fig. 1-4		RU 7803-40

verchromt/chromium bladed



Hartmann

für Säuglinge
for babies

	I Ø	A Ø	verchromt chrom. bladed	rostfrei stainless steel
Fig. 1	2,0 mm	3,0 mm	RU 7804-02	RU 7804-02 NR



Hartmann

für Kinder
for children

	I Ø	A Ø	verchromt chrom. bladed	rostfrei stainless steel
Fig. 2	3,0 mm	4,0 mm	RU 7804-03	RU 7804-03 NR
Fig. 3	4,0 mm	5,0 mm	RU 7804-04	RU 7804-04 NR
Fig. 4	5,5 mm	6,5 mm	RU 7804-05	RU 7804-05 NR
	Satz/Set Fig. 2-4		RU 7804-20	RU 7804-20 NR



Hartmann

für Erwachsene
for adults

	I Ø	A Ø	verchromt chrom. bladed	rostfrei stainless steel
Fig. 3	4,0 mm	5,0 mm	RU 7804-04	RU 7804-04 NR
Fig. 4	5,5 mm	6,5 mm	RU 7804-05	RU 7804-05 NR
Fig. 5	6,5 mm	7,5 mm	RU 7804-06	RU 7804-06 NR
Fig. 6	8,0 mm	9,0 mm	RU 7804-07	RU 7804-07 NR
	Satz/Set Fig. 4-6		RU 7804-30	RU 7804-30 NR
	Satz/Set Fig. 3-6		RU 7804-40	RU 7804-40 NR



Toynee

für Erwachsene
for adults

	I Ø	A Ø	
Fig. 0	2,0 mm	3,0 mm	RU 7805-10
Fig. 1	3,0 mm	4,0 mm	RU 7805-11
Fig. 2	4,0 mm	5,0 mm	RU 7805-12
Fig. 3	5,0 mm	6,0 mm	RU 7805-13
Fig. 4	6,0 mm	7,0 mm	RU 7805-14
	Satz/Set Fig. 2-4		RU 7805-31
	Satz/Set Fig. 1-4		RU 7805-41

verchromt/chromium bladed



Zöllner

		I Ø	A Ø	
Fig. 1	4,5 x 5,5 mm	5,5 x 6,5 mm		RU 7806-01
Fig. 2	5,5 x 6,5 mm	6,5 x 7,5 mm		RU 7806-02
Fig. 3	6,5 x 7,5 mm	7,5 x 8,5 mm		RU 7806-03
Fig. 4	7,5 x 8,5 mm	8,5 x 9,5 mm		RU 7806-04
Fig. 5	8,5 x 9,5 mm	9,5 x 10,5 mm		RU 7806-05
Fig. 6	9,5 x 10,5 mm	10,5 x 10,5 mm		RU 7806-06
	Satz/Set Fig. 1-6			RU 7806-60

Leichtmetall, schwarz eloxiert
light-metal black eloxated

I Ø = Innendurchmesser
Inner diameter

A Ø = Außendurchmesser
Outer diameter

**OHR SPEKULA
EAR SPECULA**



Gruber

	I Ø	A Ø	
Fig. 1	2,8 x 3,8 mm	3,8 x 4,8 mm	RU 7807-02
Fig. 2	3,8 x 4,8 mm	4,8 x 5,8 mm	RU 7807-03
Fig. 3	5,0 x 6,2 mm	6,0 x 7,2 mm	RU 7807-05
Fig. 4	6,0 x 7,2 mm	7,0 x 8,2 mm	RU 7807-06
Satz/Set, Fig. 2-4			RU 7807-30
Satz/Set, Fig. 1-4			RU 7807-40

verchromt
chromium bladed



Hartmann

	I Ø	A Ø	
Fig. 1	3,0 mm	4,0 mm	RU 7809-03
Fig. 2	4,0 mm	5,0 mm	RU 7809-04
Fig. 3	5,0 mm	6,0 mm	RU 7809-05
Fig. 4	7,0 mm	8,0 mm	RU 7809-07

Satz/Set, Fig. 1-4 **RU 7809-40**

schwarz verchromt
black chromium bladed



Hartmann

	I Ø	A Ø	
Fig. 5	2,5 mm	8,5 mm	RU 7809-09
Fig. 6	9,0 mm	10,0 mm	RU 7809-11
Satz/Set, Fig. 5-6			RU 7809-20

schwarz verchromt
black chromium bladed



Boucheron

	I Ø	A Ø	
Fig. 1	3,5 mm	4,5 mm	RU 7811-03
Fig. 2	4,5 mm	5,5 mm	RU 7811-04
Fig. 3	5,5 mm	6,5 mm	RU 7811-05
Fig. 4	6,5 mm	7,5 mm	RU 7811-06
Fig. 5	7,6 mm	8,5 mm	RU 7811-07
Fig. 6	9,1 mm	10,0 mm	RU 7811-08

Satz/Set, Fig. 1-4 **RU 7811-40**

verchromt
chromium bladed

**Metallständer für 12 Ohrspekula
Metal stand for 12 ear specula**

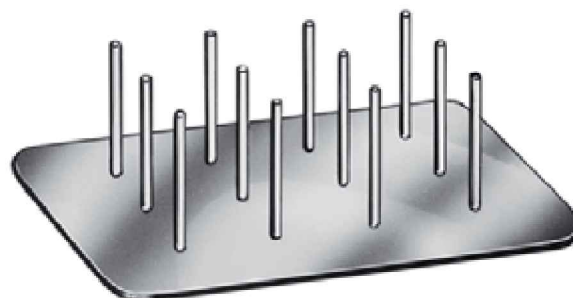

RU 7810-12

I Ø = Innendurchmesser
Inner diameter

A Ø = Außendurchmesser
Outer diameter

**OHR SPEKULA
EAR SPECULA**

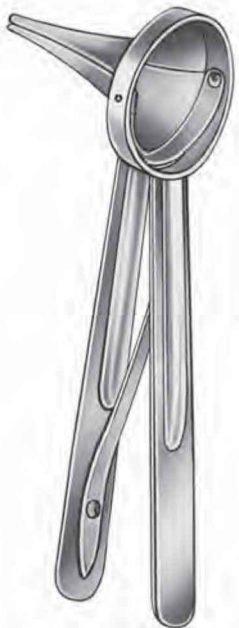

	I Ø	A Ø	Ref.
Fig. 1	2,0 mm	3,0 mm	RU 7813-02
Fig. 2	3,0 mm	4,0 mm	RU 7813-03
Fig. 3	4,0 mm	5,0 mm	RU 7813-04
Fig. 4	5,0 mm	6,0 mm	RU 7813-06

verchromt
chromium bladed

I Ø = Innendurchmesser
Inner diameter

A Ø = Außendurchmesser
Outer diameter

Richnau Holmgren



Siegle

6,5 mm



RU 7814-06

8 mm



RU 7814-07

9 mm



RU 7814-08

- RU 7814-00** Ohrspekula, kpl. mit 3 Spekula und Gebläse, mit Vergrößerung
Ear specula, cpl. with 3 specula and rubber bulb, with magnification
- RU 7814-50** Ohrspekula, kpl. mit 3 Spekula und Gebläse, ohne Vergrößerung
Ear specula, cpl. with 3 specula and rubber bulb, without magnification
- RU 7814-01** Siegle Lupe, allein, mit Vergrößerung
Siegle magnifying glass, only, with magnification
- RU 7814-51** Siegle Lupe, allein, ohne Vergrößerung
Siegle magnifying glass, only, without magnification
- RU 7814-99** Siegle Gebläse, allein
Siegle rubber bulb with tube, only

**OHR SPEKULA
EAR SPECULA**



Brünings

- Fig. 00 – 4 mm
RU 7815-04
- Fig. 0 – 4,8 mm
RU 7815-05
- Fig. 1 – 6 mm
RU 7815-06
- Fig. 2 – 7,5 mm
RU 7815-07
- Fig. 3 – 8,2 mm
RU 7815-08
- Fig. 4 – 10,5 mm
RU 7815-10
- Fig. 5 – 12,5 mm
RU 7815-12

- RU 7815-00** Ohrspekula-Set mit 4 Spekula, mit Vergrößerung (Fig. 0-3)
Ear specula set with 4 specula, with magnification (Fig. 0-3)
- RU 7815-50** Ohrspekula-Set mit 4 Spekula, ohne Vergrößerung (Fig. 0-3)
Ear specula set with 4 specula, without magnification (Fig. 0-3)
- RU 7815-16** Ohrspekula-Set mit 6 Spekula, mit Vergrößerung (Fig. 00-4)
Ear specula set with 6 specula, with magnification (Fig. 00-4)
- RU 7815-66** Ohrspekula-Set mit 6 Spekula und RU 7815-52, ohne Vergrößerung (Fig. 00-4)
Ear specula set with 6 specula and RU 7815-52, without magnification (Fig. 00-4)
- RU 7815-01** Lupe allein, mit Vergrößerung
Magnifying glass, only, with magnification
- RU 7815-51** Lupe allein, ohne Vergrößerung
Magnifying glass, only, without magnification
- RU 7815-99** Gebläse allein, mit Konusstecker
Rubber bulb and tube with cone plug
- RU 7815-52** OP-Lupenkörper mit Segmentausschnitt, ohne Vergrößerung
Magnifying glass body with segment detail, without magnification

**STIMMGABELN
TUNING FORKS**



**a¹ 440
RU 7818-00**



Hartmann



**Lucae
Hartmann**



French

C²	16			RU 7824-16
C²	32			RU 7824-32
C	64			RU 7825-01
C	128	RU 7820-00	RU 7822-00	RU 7825-02
C¹	256	RU 7820-01	RU 7822-01	RU 7825-03
C²	512	RU 7820-02	RU 7822-02	
C³	1024	RU 7820-03	RU 7822-03	
C⁴	2048	RU 7820-04	RU 7822-04	
C⁵	4096	RU 7820-05	RU 7822-05	



**Lucae
C 128**



**Hartmann
C 128**

verschiebbar bis h
variable up to h (Engl. b)
RU 7826-00 **RU 7827-00**

**STIMMGABELN
TUNING FORKS**

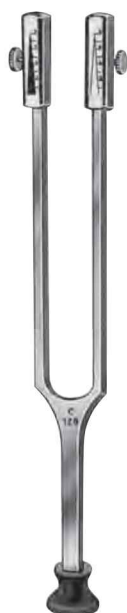

mit Dämpfer = C 64
 ohne Dämpfer = C 128
 with clamps = C 64
 without clamps = C 128

**Rydel-Seiffer
C 64/C 128
RU 7828-00**



Stimmgabel
 für neurologische Untersuchungen,
 mit Reflexhammer, Nadelrad, Pinsel
 und Nadel

*Tuning fork
 for neurological examinations,
 with percussion hammer, pin wheel,
 brush and needle*

RU 7829-00

**STIMMGABELBESTECKE
TUNING FORK SETS**



RU 7830-05

Satz zu 5 Stimmgabeln, enthaltend:
Set of 5 tuning forks, containing:

**RU 7820-02
RU 7820-03
RU 7820-04
RU 7825-02
RU 7825-03**

RU 7830-06

Satz zu 6 Stimmgabeln, enthaltend:
Set of 6 tuning forks, containing:

**RU 7820-02
RU 7820-03
RU 7820-04
RU 7820-05
RU 7825-02
RU 7825-03**

RU 7830-08

Satz zu 8 Stimmgabeln, enthaltend:
Set of 8 tuning forks, containing:

**RU 7820-02
RU 7820-03
RU 7820-04
RU 7820-05
RU 7824-32
RU 7825-01
RU 7825-02
RU 7825-03**

**STIMMGABELN
TUNING FORKS**



**C 64
RU 7831-01**



**C 128
RU 7831-02**



**C 256
RU 7831-03**



**C 512
RU 7831-04**



**C 1024
RU 7831-05**



**C 2048
RU 7831-06**



**C 4096
RU 7831-07**

Stimmgabeln aus Spezial Aluminium-Magnesium-Legierung für medizinische Zwecke z. B. für Gehörprüfungen (Luft- und Knochenleitung), für Sensibilitätsprüfungen und andere diagnostische Zwecke.

Tuning forks made of a special aluminium-magnesium-alloy, for medical purposes, such as examination of hearing (air and bone conduction), for sensibility examinations and other diagnostic purposes.



RU 7832-05

Satz zu 5 Stimmgabeln, enthaltend:
Set of 5 tuning forks, containing:

- RU 7831-02**
- RU 7831-03**
- RU 7831-04**
- RU 7831-05**
- RU 7831-06**

**LÄRMTROMMELN
NOISE APPARATUS**



**Barany
RU 7835-00**



**Barany
(Barany-Frenzel)
RU 7836-00**

SAUGROHRE, SAUGADAPTER
SUCTION TUBES, SUCTION ADAPTER

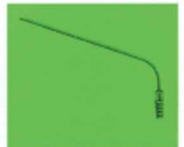

Hartmann
13,5 cm/5 1/4"

- Ø 2,5 mm
RU 7840-20
- Ø 3,0 mm
RU 7840-25
- Ø 3,5 mm
RU 7840-30
- Ø 4,0 mm
RU 7840-40
- Ø 5,0 mm
RU 7840-50



Itard
13 cm/5"

- Ø 3,0 mm
RU 7841-30
- Ø 3,5 mm
RU 7841-35
- Ø 4,0 mm
RU 7841-40
- Ø 4,5 mm
RU 7841-45
- Ø 5,0 mm
RU 7841-50

Saugadapter mit Saugunterbrecher
(Schlauchverbinder)
Suction adapter, with finger cut-off
(Tube connector)



House
5,5 cm/2 1/8"
RU 7842-00



House (Fisch)
5,5 cm/2 1/8"
RU 7842-00/05



10 cm/4"
RU 7842-00/10

Saughandgriffe, mit Unterbrecher,
mit LUER_Konus
Suction handels, with finger out-off,
with LUER cone

1/1



10,5 cm - 4"
RU 7842-00/20

Saugset komplett,
Suction set, complete

bestehend aus,
consisting of:

- RU 7842-00/21**
- 1 x **RU 7842-00/20**
 - 2 x **RU 7842-10**
 - 2 x **RU 7842-11**
 - 2 x **RU 7842-12/1**
 - 2 x **RU 7842-13/1**

Siehe Seite 197
see page 197



Rosen (House)
Ø 0,5 mm
RU 7842-10

Saugkanüle
Suction cannula

1/1

**SAUGINSTRUMENTE
SUCTION INSTRUMENTS**

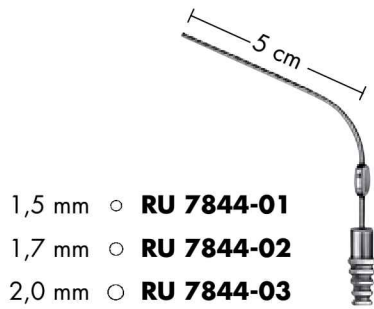

Barnes

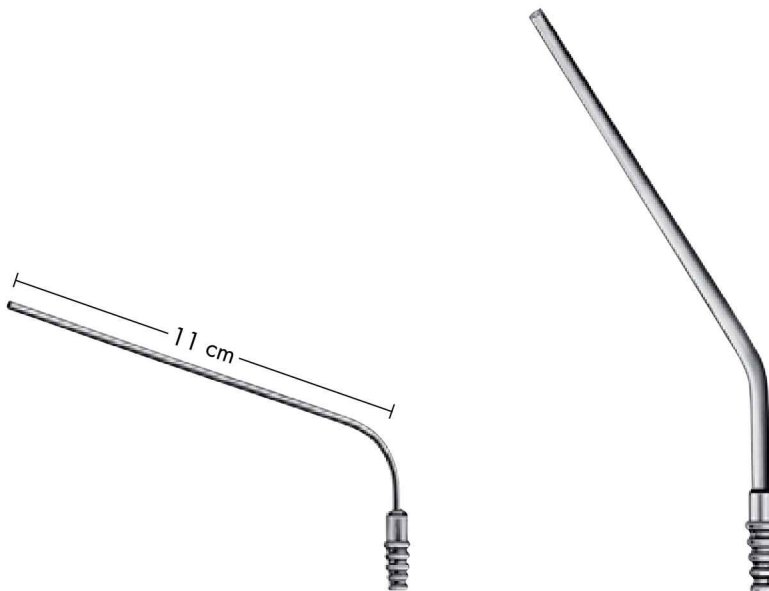

Ø	Zylindrisch cylindrical		Konisch conical	
	Nutzlänge 9 cm	Nutzlänge 11 cm	Nutzlänge 11 cm	Nutzlänge 13 cm
○ 1,0	RU 7844-31			
○ 1,5	RU 7844-32			
○ 2,0	RU 7844-33			
○ 2,5		RU 7844-44		
○ 3,0		RU 7844-45	RU 7844-55	
○ 3,5			RU 7844-56	
○ 4,0		RU 7844-47		
○ 4,5				RU 7844-68
○ 5,0		RU 7844-49		



**SAUGROHRE
SUCTION TUBES**

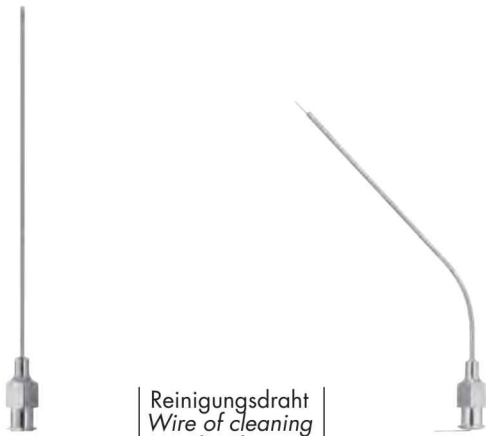

Außen Ø Outer Diam. Ø	Rosen 8 cm/3 1/4"	Reinigungsdraht Wire of cleaning für/for Rosen Rosen (House)	Rosen (House)
0,5 mm	RU 7842-50	RU 7842-92	RU 7842-10
0,7 mm	RU 7842-01	RU 7842-93	RU 7842-11
0,8 mm	RU 7842-51	RU 7842-93	RU 7842-11/1
0,9 mm	RU 7842-02	RU 7842-95	RU 7842-12
1,0 mm	RU 7842-52	RU 7842-95	RU 7842-12/1
1,2 mm	RU 7842-03	RU 7842-95	RU 7842-13
1,4 mm	RU 7842-53	RU 7842-95	RU 7842-13/1
1,5 mm	RU 7842-54	RU 7842-95	RU 7842-14
1,8 mm	RU 7842-55	RU 7842-96	RU 7842-18
2,0 mm	RU 7842-56	RU 7842-96	RU 7842-20
2,5 mm	RU 7842-57	RU 7842-96	RU 7842-25
3,0 mm	RU 7842-58	RU 7842-96	RU 7842-30

mit Saugunterbrecher
und Mandrin
with finger cut-off
and stylet



Saugrohr Suction tube Ø	Spülrohr irrigation tube Ø	
0,9 mm	0,7 mm	RU 7843-01
1,2 mm	0,9 mm	RU 7843-02
1,5 mm	1,2 mm	RU 7843-03
1,8 mm	1,8 mm	RU 7843-04
2,5 mm	2,0 mm	RU 7843-05
3,0 mm	2,0 mm	RU 7843-06
4,5 mm	2,0 mm	RU 7843-07

House



Olive
Ø 8 mm

Baron
14 cm/5 1/2"



Nadelsauger,
Suction Needle

Olive
Ø 8 mm

Schuknecht
13 cm/5"

Ø mm	Charr./Fr.	
1,0	3	RU 7845-03
1,5	5	RU 7845-05
2,3	7	RU 7845-07

Ø mm	Gauge	
0,9	20	RU 7845-20
0,7	22	RU 7845-22
0,5	24	RU 7845-24



10 cm/4"

biegsam/malleable

Ø mm	10 cm/4"	
0,5	RU 7846-35	
0,7	RU 7846-37	
1,0	RU 7846-40	
1,3	RU 7846-43	
1,5	RU 7846-45	
2,0	RU 7846-50	
2,5	RU 7846-55	
3,0	RU 7846-60	

Saugrohr,
zylindrisch aus Silber mit Mandrin,
Olive mit LUER-Bohrung
Suction tube,
cylindrical, silver, with stylet,
olive with LUER tub



Wullstein
14 cm/5 1/2"

Ø mm	Charr./Fr.	
1,5	5	RU 7847-15
2,0	6	RU 7847-20

SAUGROHRE / SAUG- UND SPÜLKANÜLEN
SUCTION TUBES / SUCTION AND IRRIGATION CANNULAE

Ø 2,5 mm

Saugkanüle, allein mit Mandrin,
passend zu den Saugaufsätzen
RU 7848-05 - RU 7848-12
Suction cannula only, with stylet,
fitting to the detachable ends
RU 7848-05 - RU 7848-12



Abnehmbare Feinstsauger,
zu RU 7848-00
Detachable ends,
fitting to RU 7848-00

Ø 0,5 mm **RU 7848-05**
Ø 0,7 mm **RU 7848-07**
Ø 0,9 mm **RU 7848-09**
Ø 1,2 mm **RU 7848-12**

Zöllner
15,5 cm/6"
RU 7848-00



Fisch

zylindrisch/cylindrical
Saug-/Spülrohr
suction/irrigation cannulae

Ø Saugrohr Ø Suction tube	Ø Spülrohr Ø Irrigation tube	
4,5 mm	2,0 mm	RU 7849-45
3,0 mm	2,0 mm	RU 7849-30
2,5 mm	2,0 mm	RU 7849-25
1,8 mm	1,8 mm	RU 7849-18
1,5 mm	1,5 mm	RU 7849-15
1,0 mm	1,0 mm	RU 7849-10

10 cm/4"



Fergusson

Ø mm	Charr./Fr.	
2,0	6	RU 6421-06
2,3	7	RU 6421-07
2,5	8	RU 6421-08
3,0	9	RU 6421-09
3,3	10	RU 6421-10
3,5	11	RU 6421-11
4,0	12	RU 6421-12
5,0	15	RU 6421-15

mit Saugunterbrecher und Mandrin
Griffplatte parallel zur Biegung,
LUER-Bohrung
with finger cut-off and stylet
thumb piece parallel to curve

Ø mm	Charr./Fr.	
1,5	5	RU 6422-15
2,0	6	RU 6422-20
2,5	8	RU 6422-25
3,0	9	RU 6422-30



Plester
19,5 cm/7 3/4"

**POLYPENSCHNÜRER, POLYPENSCHLINGEN
POLYPUS SNARES, WIRE LOOPS**



Krause
18 cm/7¼"
RU 7850-16



Krause-Voss
18 cm/7¼"
RU 7852-16

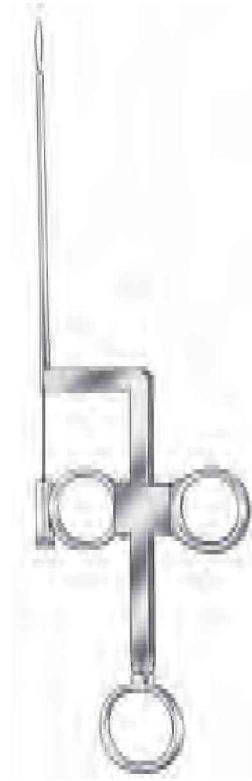

Lange-Wilde
18 cm/7¼"
RU 7854-16



10 m/33 ft.

Ø 0,3 mm **RU 7856-03**
Ø 0,4 mm **RU 7856-04**



Packung à 12 Stück
package of 1 dozen each

Ø 0,2 mm **RU 7857-02**
Ø 0,3 mm **RU 7857-03**

Packung à 100 Stück
package of 100 pieces each

Ø 0,2 mm **RU 7857-02/00**
Ø 0,3 mm **RU 7857-03/00**

OHRZÄNGCHEN, FREMDKÖRPERHEBEL
EAR FORCEPS, FOREIGN BODY LEVERS



Littauer
12 cm/4¾"
RU 7869-12



Standard
Standard
RU 7870-12



Hartmann
12 cm/4¾"
RU 7870-12



feines Modell
fine pattern
RU 7870-12/1



Hartmann
14 cm/5½"
normales Modell
standard pattern
RU 7870-14



Tilley
14 cm/5½"
RU 7871-14



Buck
9 cm/3½"
RU 7872-00



Quire
8 cm/3¼"
RU 7873-00

**OHRZÄNGCHEN
EAR FORCEPS**



Schaftlänge
Length of shaft
8,5 cm/3¼"



Hartmann-Noyes
RU 7878-00



Hartmann-Noyes
RU 7878-12



RU 7879-00

8,5 cm/3¼"
14 cm/5½"



Hartmann
RU 7880-09
RU 7880-14



Hartmann
RU 7881-09
RU 7881-14

8,5 cm/3¼"
8,5 cm/3¼"
8,5 cm/3¼"



Hartmann
RU 7882-20 ○ 2,0 mm
RU 7882-25 ○ 2,5 mm
RU 7882-30 ○ 3,0 mm



Hartmann-Citelli
RU 7883-09/02 ○ 2 mm
RU 7883-09 ○ 3 mm

**OHRZÄNGCHEN
EAR FORCEPS**



Strümpel-Voss
11 cm
RU 7884-11



Strümpel
8,5 cm/3³/₄" **RU 7884-09**
10 cm/4" **RU 7884-10**



8,5 cm/3¹/₄" **Hartmann-Weingärtner**
RU 7885-09



Hartmann
RU 7886-09



Hartmann-Wullstein
0,8 x 6 mm **RU 7887-06**
1,8 x 8 mm **RU 7887-08**



8,5 cm/3¹/₄" **Hartmann-Wullstein**
○ 1 mm **RU 7888-01**
○ 2 mm **RU 7888-02**



Hartmann
RU 7889-00



Hartmann
RU 7889-01

**MIKRO-OHRZÄNGCHEN
MICRO EAR FORCEPS**



Schaftlänge 8 cm
Length of shaft 8 cm

**Mikrozangen
Micro Forceps**

	1,6 x 7,0 mm	Mini 0,7 x 3,5 mm	Superfein superdelicate
	RU 7890-21	RU 7890-28	
	0,8 x 4,0 mm	0,6 x 4,0 mm	0,4 x 4,0 mm
Schaftlänge Standard 8 cm length of shaft 10 cm	RU 7890-22 RU 7890-22/10	RU 7890-29	RU 7890-35
glattes Maul smooth jaw	0,8 x 4,0 mm		
	RU 7890-23		
links gebogen curved left	0,8 x 6,0 mm	0,6 x 4,0 mm	
	RU 7890-24	RU 7890-31	
rechts gebogen curved right	0,8 x 6,0 mm	0,6 x 4,0 mm	
	RU 7890-25	RU 7890-32	
aufgebogen angled up	0,8 x 4,0 mm	0,6 x 4,0 mm	0,4 x 4,0 mm
	RU 7890-26	RU 7890-33	RU 7890-36
abgebogen angled down	0,8 x 4,0 mm		
	RU 7890-27		

LÖFFELZANGEN, DRAHTBIEGEZÄNGCHEN
CUP-SHAPED FORCEPS, WIRE BENDING FORCEPS

Löffelzangen Cup-shaped forceps		Drahtbiegezüngchen Wire Bending Forceps	
gerade <i>straight</i>	0,5 x 0,6 mm RU 7891-11	0,9 x 1,1 mm RU 7891-31	Mc Gee 0,8 x 3,5 mm RU 7891-45
links gebogen <i>curved left</i>	0,5 x 0,6 mm RU 7891-12	0,9 x 1,1 mm RU 7891-32	links gebogen <i>curved left</i> RU 7891-46
rechts gebogen <i>curved right</i>	0,5 x 0,6 mm RU 7891-13	0,9 x 1,1 mm RU 7891-33	rechts gebogen <i>curved right</i> RU 7891-47
aufgebogen <i>angled up</i>	0,5 x 0,6 mm RU 7891-14	0,9 x 1,1 mm RU 7891-34	leicht nach unten gebogen <i>slightly curved downwards</i> RU 7891-49
abgebogen <i>angled down</i>		0,9 x 1,1 mm RU 7891-35	Mikrozangen Micro forceps gerade/ <i>straight</i> RU 7891-36
			Greven 0,8 x 5,0 mm

Hammerkopfstanze
Malleus Nipper

oben schneidend <i>upwards cutting</i>	Dieter RU 7891-50
unten schneidend <i>downwards cutting</i>	Dieter RU 7891-51
rechts schneidend <i>cutting to the right</i>	Dieter RU 7891-52
links schneidend <i>cutting to the left</i>	Dieter RU 7891-53

Schaftlänge 8 cm
Length of shaft 8 cm



**MIKRO-OHRSCHEREN
MICRO-EAR SCISSORS**

**Mikroscheren
Micro scissors**

gerade, spitz/spitz
straight, sharp/sharp

Bellucci
4,0 mm



Schaftlänge 8 cm
length of shaft 10 cm

RU 7892-11
RU 7892-11/00

gerade, spitz/stumpf
straight, sharp/blunt



8 cm **RU 7892-11/01**

aufgebogen, spitz/spitz
angled up, sharp/sharp



8 cm **RU 7892-11/02**

rechts gebogen, spitz/spitz
curved right, sharp/sharp



8 cm **RU 7892-11/03**

links gebogen, spitz/spitz
curved left, sharp/sharp



8 cm **RU 7892-11/04**

gerade, fein, spitz/spitz
straight, delicate



8 cm **RU 7892-11/13**

gerade
straight

Bellucci
5,5 mm



Schaftlänge 8 cm
length of shaft

RU 7892-12

aufgebogen
angled up

Bellucci
5,5 mm



8 cm **RU 7892-13**

links gebogen
curved left

Bellucci
5,5 mm



8 cm **RU 7892-14**

rechts gebogen
curved right

Bellucci
5,5 mm



8 cm **RU 7892-15**

gerade
straight

Shea
7,0 mm



8 cm **RU 7892-16**

links gebogen
curved left

Shea
7,0 mm



8 cm **RU 7892-17**

rechts gebogen
curved right

Shea
7,0 mm



8 cm **RU 7892-18**

MIKRO-OHRZANGEN
MICRO EAR FORCEPS

Schaftlänge 8 cm
Length of shaft 8 cm



glattes Maul
smooth jaw

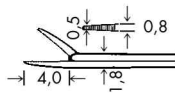

0,5 mm
gerade
straight

RU 7893-01/04

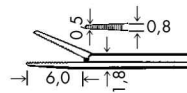

RU 7893-01/06

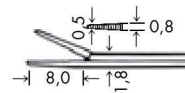

RU 7893-01/08

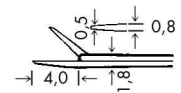

RU 7893-09/04

rechts gebogen
curved right

RU 7893-02/04

links gebogen
curved left

RU 7893-03/04

aufgebogen, horizontal
angled up, horizontal

RU 7893-04/04

abgebogen, horizontal
angled down, horizontal

RU 7893-05/04

glattes Maul
smooth jaw

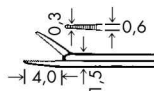

0,3 mm
gerade
straight

RU 7893-11/04

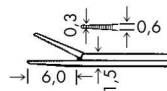

RU 7893-11/06

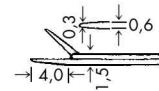

RU 7893-19/04

Diese Zängchen sind gegen Aufpreis auch in schwarz verchromter Ausführung lieferbar.
These micro forceps can also be supplied in black-chromed finish for a slightly higher price.

MIKRO-LÖFFELZANGEN, MIKRO-SCHEREN
MICRO-CUP-SHAPED FORCEPS, MICRO SCISSORS



Löffelzangen
Cup-shaped forceps

Schaftlänge 8 cm
Length of shaft 8 cm



Mikro-Scheren
Micro-scissors

1,5 x 0,8 mm

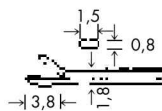

gerade
straight

RU 7893-21/04

rechts gebogen
curved right

RU 7893-22/04

links gebogen
curved left

RU 7893-23/04

aufgebogen, horizontal
angled up, horizontal

RU 7893-24/04

abgebogen, horizontal
angled down, horizontal

RU 7893-25/04

Bellucci
3,0 mm

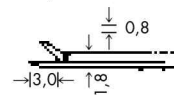

RU 7893-41/03

RU 7893-42/03

RU 7893-43/03

RU 7893-44/03

RU 7893-45/03

Bellucci
4,0 mm

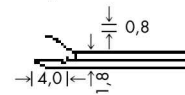

RU 7893-41/04

RU 7893-42/04

RU 7893-43/04

RU 7893-44/04

RU 7893-45/04

1,0 x 0,5 mm

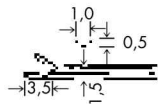

gerade
straight

RU 7893-31/04

Diese Zängchen sind gegen Aufpreis auch in schwarz verchromter Ausführung lieferbar.
These micro-forceps can also be supplied in black-chromed finish for a slightly higher price.

MIKRO-INSTRUMENTE, OP-GESTELL, SCHUTZHÜLSE
MICRO-INSTRUMENTS, OP-RACK, PROTECTIVE SHIELD



Schaftlänge 8 cm
 Length of shaft 8 cm

Crurotomie-Schere
 Crurotomy scissors

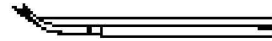

links öffnend
 open to left

Fisch
RU 7893-50/02

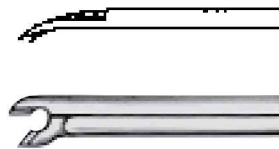

rechts öffnend
 open to right

Fisch
RU 7893-50/01



Schaftlänge 8 cm
 Length of shaft 8 cm

Mc Gee/Fisch
RU 7893-52

Drahtbiegezängchen
 Wire bending forceps

Diese Zängchen sind gegen Aufpreis auch in schwarz verchromter Ausführung lieferbar.
 These micro forceps can also be supplied in black-chromed finish for a slightly higher price.

Operationsgestell zum Aufbewahren und Sterilisieren von 6 Ohrzängchen
OP-rack for storage and sterilization of 6 ear forceps

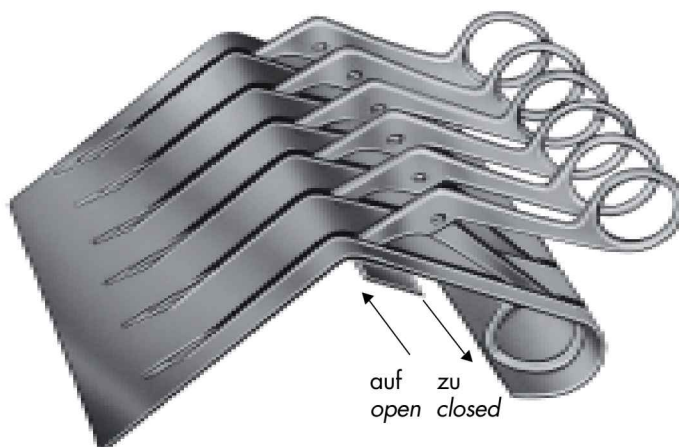

auf zu
 open closed

RU 7893-60/06



11,5 cm
RU 8882-01
 Schutzhülse, Teflon,
 autoklavierbar
 Protective shield, teflon,
 autoclavable

TUBENINSTRUMENTARIUM
TUBE INSTRUMENTATION

Einführungsinstrument für Ventilation-Tuben
Inserters for ventilation tubes



RU 7893-55

Einführungsinstrument für T-Tuben
Inserters for T-tubes



Einsetzinstrument für C-Flex,
T-Form-Paukenröhrchen

Exaktes Einsetzen von T-Form-Pauken-
röhrchen durch 6, 9 und 12 mm lange,
3-stufige Hubwegvorrichtung

T-tube inserter

*Adjustment to the required
setting (3 steps), allows a precise
insertion of 6, 9 and 12 mm T-tubes*

RU 7893-56

Längenmessinstrument
Microsurgical sliding gauge



Längenmessinstrument
für Stapedektomie und Tympanoplastik
mit 0-9 mm Mess-Skala, autoklavierbar,
18 cm

RU 7893-57

*Microsurgical sliding gauge
for stapedectomy and tympanoplasty
with 0-9 mm measuring scale,
autoclavable 18 cm*

RU 7893-57

Myringotome entnehmen Sie bitte Seite 239
For myringotomes please refer to page 239

PAUKENRÖHRCHEN VENTILATION TUBES

Kurzzeitige Anwendung Short-term application

Shepard Grommet

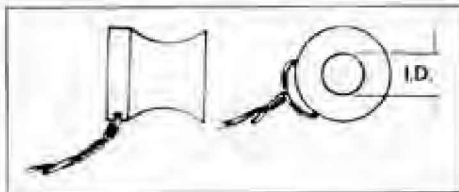

Können leicht mit einem Faßzängchen oder Tubeneinführinstrument durch eine Inzision ins Trammelfell eingesetzt werden (siehe RU 7893-55, Seite 209)

*Easily inserted with forceps or tube inserter through incision in drum.
(see RU 7893-55, page 209)*

Verpackungseinheit / Units per box: 6 Stück/pieces

	Material/Material	Ø ID mm	Bezeichnung/Description
RU 7950-01/01	Fluoroplastik/Fluoroplastic	1,02	
RU 7950-01/02	Fluoroplastik/Fluoroplastic	1,02	mit Draht/With wire
RU 7950-01/03	Fluoroplastik/Fluoroplastic	1,14	
RU 7950-01/04	Fluoroplastik/Fluoroplastic	1,14	mit Draht/With wire
RU 7950-01/05	Silikon/Silicone	1,02	mit Lasche/With tab

Donaldson

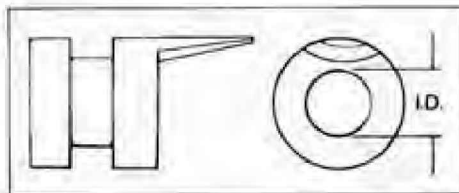

Flansche verhindern die Migration und Extrusion. Ein weites Lumen begünstigt die Drainage.

Flanges resist migration and extrusion. Large lumen promotes good ventilation.

Verpackungseinheit / Units per box: 6 Stück/pieces

	Material/Material	Ø ID mm	Bezeichnung/Description
RU 7950-02/01	Silikon/Silicone	1,14	
RU 7950-02/02	Silikon/Silicone	1,14	mit Lasche/With tab
RU 7950-02/03	Silikon, weich/Soft silicone	1,14	
RU 7950-02/04	Ultrasil/Ultrasil silicone	1,14	

Mittelfristige Anwendung Middle-term application

Collar Button

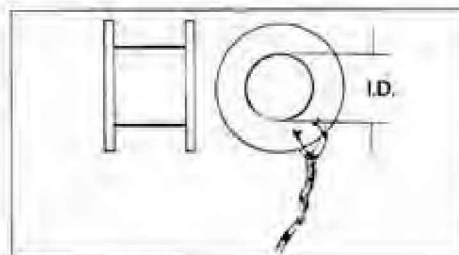

Kragenknopfförmige Paukendrainage für die Behandlung chronischer Otitis media. A „collar-button“ shaped ventilation tube for treatment of chronic, serious otitis media.

Verpackungseinheit / Units per box: 6 Stück/pieces

	Material/Material	Ø ID mm	Bezeichnung/Description
RU 7950-10/01	Fluoroplastik/Fluoroplastic	1,27	
RU 7950-10/02	Fluoroplastik/Fluoroplastic	1,27	mit Draht/With wire

Reuter Bobbin

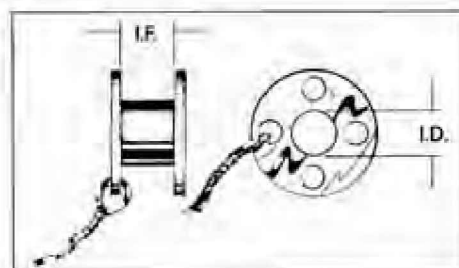

Diese spulenförmige Drainage hat einen breiten Flansch, der eine Extrusion verhindert.

The ventilation tube features a wide flange to help resist extrusion.

Verpackungseinheit / Units per box: 6 Stück/pieces

	Material/Material	Ø ID mm	Bezeichnung/Description
RU 7950-11/01	Fluoroplastik/Fluoroplastic	1,14	mit Draht/With wire
RU 7950-11/02	Fluoroplastik/Fluoroplastic	1,14	
RU 7950-11/03	Fluoroplastik/Fluoroplastic	1,27	
RU 7950-11/04	Rostfr. Stahl/Stainless steel	1,14	
RU 7950-11/05	Rostfr. Stahl/Stainless steel	1,27	
RU 7950-11/06	Rostfr. Stahl/Stainless steel	1,00	

PAUKENRÖHRCHEN VENTILATION TUBES

Langfristige Anwendung Long-term application

Tuebinger Paukenröhrchen

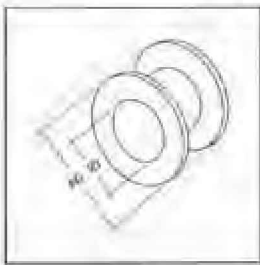

Verpackungseinheit / Units per box: 10 Stück/pieces

	Material/Material	ID Ø mm	AD / OD Ø mm
RU 7950-15/01	Silber-vergoldet/Silver plated	1,25	2,55
RU 7950-15/02	Silber-vergoldet/Silver plated	1,25	2,55 mit Draht/With wire
RU 7950-15/03	Silber-vergoldet/Silver plated	1,50	2,80
RU 7950-15/04	Silber-vergoldet/Silver plated	1,50	2,80 mit Draht/With wire

	Material/Material	ID Ø mm	AD / OD Ø mm
RU 7950-16/01	Titan/Titanium ASTM F67	1,25	2,55
RU 7950-16/02	Titan/Titanium ASTM F67	1,25	2,55 mit Draht/With wire
RU 7950-16/03	Titan/Titanium ASTM F67	1,50	2,80
RU 7950-16/04	Titan/Titanium ASTM F67	1,50	2,80 mit Draht/With wire

Paparella

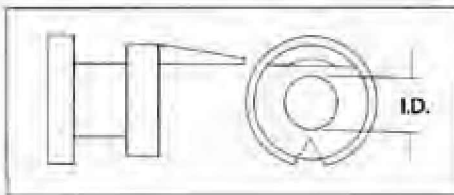

Der innere Flansch ist mit einer Kerbe versehen und ermöglicht eine „twist-in“-Einsetzung. Sehr dauerhaft und haltbar bei langfristiger Implantation.
Notched inner flange for „twist-in“ insertion. Very stable for long-term implantation.

Verpackungseinheit / Units per box: 6 Stück/pieces

	Material/Material	ID Ø mm	Bezeichnung/Description
RU 7950-20/01	Silikon/Silicone	1,02	mit Lasche/With tab
RU 7950-20/02	Silikon/Silicone	1,27	mit Lasche/With tab
RU 7950-20/03	Silikon/Silicone	2,03	mit Lasche/With tab
RU 7950-20/04	Ultrasil/Ultrasil silicone	1,02	mit Lasche/With tab

T-förmig

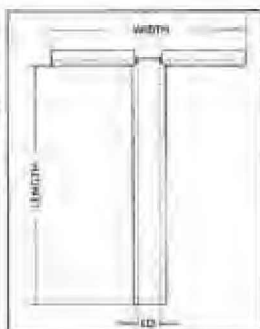

T-Tuben mit flexiblen Flanschen zur Langzeit-Ventilation. Einfache Einführung mit **Rudolf** T-Tube-Einführungsinstrument (RU 7893-56, Seite 209). Die T-Tube besteht aus blauem Silikon und ist kürzbar.

T-tubes with soft flanges for a long-term ventilation. The tube is easily inserted with the **Rudolf** T-tube inserter (RU 7893-56, page 209). All are made of blue silicone rubber and are easily trimmed.

Verpackungseinheit / Units per box: 6 Stück/pieces

	Material/Material	Ø ID mm	Abmessungen/Dimensions
RU 7950-21/01	Silikon/Silicone	1,14	12 x 9,8 mm
RU 7950-21/02	Silikon, weich/Soft silicone	1,14	12 x 9,8 mm
RU 7950-21/03	Ultrasil/Ultrasil silicone	1,14	12 x 9,8 mm



Silikon-Folien für medizinische Zwecke,
Silicone sheeting for medical purposes,

unsteril, verstärkt
non sterile, reinforced
200 x 150 x 0,175 mm

RU 7950-17/01

unsteril, unverstärkt
non sterile, non-reinforced
200 x 150 x 0,125 mm

RU 7950-17/02

MITTELOHR-IMPLANTATE MIDDLE-EAR IMPLANTS

Stapedotomie / Stapedektomie Stapedotomy / Stapedectomy

Platinum and Teflon Prosthesis¹⁾ for Stapedotomy and Stapedectomy¹⁾

¹⁾ Auch als Titan-Prothese erhältlich.
Bitte den Zusatz „Ti“ für die entsprechende Art.- Nr. verwenden.
¹⁾ Titanium made prosthesis also available.
Please add the suffix „Ti“ for each art.no.

	Länge/Length(A)
	RU 7950-30/01 4,00 mm
	RU 7950-30/02 4,25 mm
	RU 7950-30/03 4,50 mm
	RU 7950-30/04 4,75 mm
	RU 7950-30/05 5,00 mm
	RU 7950-30/06 5,25 mm
	RU 7950-30/07 5,50 mm
	RU 7950-30/08 5,75 mm

Kolben / Piston: Ø 0.40 mm

	Länge/Length(A)
	RU 7950-31/01 4,00 mm
	RU 7950-31/02 4,25 mm
	RU 7950-31/03 4,50 mm
	RU 7950-31/04 4,75 mm
	RU 7950-31/05 5,00 mm
	RU 7950-31/06 5,25 mm
	RU 7950-31/07 5,50 mm
	RU 7950-31/08 5,75 mm

Kolben / Piston: Ø 0.50 mm

	Länge/Length(A)
	RU 7950-32/01 4,00 mm
	RU 7950-32/02 4,25 mm
	RU 7950-32/03 4,50 mm
	RU 7950-32/04 4,75 mm
	RU 7950-32/05 5,00 mm
	RU 7950-32/06 5,25 mm
	RU 7950-32/07 5,50 mm
	RU 7950-32/08 5,75 mm

Kolben / Piston: Ø 0.60 mm

	Länge/Length(A)
	RU 7950-33/01 4,00 mm
	RU 7950-33/02 4,25 mm
	RU 7950-33/03 4,50 mm
	RU 7950-33/04 4,75 mm
	RU 7950-33/05 5,00 mm
	RU 7950-33/06 5,25 mm
	RU 7950-33/07 5,50 mm
	RU 7950-33/08 5,75 mm

Kolben / Piston: Ø 0.80 mm

Shortable Platinum and Teflon Prosthesis for Stapedotomy and Stapedectomy

	Länge/Length(A): 7.00 mm	Ø mm
	Kürzbar auf/ shortable to: 4,25 mm	Kolben/Piston
	RU 7950-34/01	0.4 mm
	RU 7950-34/02	0.5 mm
	RU 7950-34/03	0.6 mm
	RU 7950-34/04	0.8 mm

Platinum and AUDIO-PE® Prosthesis for Stapedectomy

	Länge/Length(A)
	RU 7950-35/01 3,50 mm
	RU 7950-35/02 4,00 mm
	RU 7950-35/03 4,25 mm
	RU 7950-35/04 4,50 mm
	RU 7950-35/05 4,75 mm
	RU 7950-35/06 5,00 mm
	RU 7950-35/07 5,50 mm

Kolben / Piston: Ø 0.60 mm

Platinum Prosthesis for Stapedectomy

	Länge/Length(A)
	RU 7950-36/01 3,00 mm
	RU 7950-36/02 3,50 mm
	RU 7950-36/03 4,00 mm
	RU 7950-36/04 4,25 mm
	RU 7950-36/05 4,50 mm
	RU 7950-36/06 4,75 mm
	RU 7950-36/07 5,00 mm
	RU 7950-36/08 5,50 mm
	RU 7950-36/09 6,00 mm

	Länge/Length(A)
	RU 7950-37/01 6,00 mm

Kolben / Piston: Ø 0.30 mm

	Länge/Length(A)
	RU 7950-38/01 4,00 mm
	RU 7950-38/02 4,50 mm
	RU 7950-38/03 5,00 mm

Platinkugel /
Platinum sphere: Ø 0.40 mm

	Länge/Length(A)
	RU 7950-39/01 4,00 mm
	RU 7950-39/02 4,50 mm
	RU 7950-39/03 5,00 mm

Platinhaken /
Platinum loop: Ø 0.40 mm

PT / PTFE / AUDIO-HA Adjustable Cup Prosthesis for Stapedectomy

	Cup AD / OD:	2.10 mm
	Cup ID / ID:	1.00 mm
	Columella Ø:	0,60 mm

	Länge/Length(A)
RU 7950-40/01	6,00 mm

TEFLON LOOPS Prosthesis for Stapedotomy and Stapedectomy*

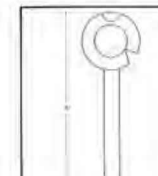
	Gesamtlänge/Total length(A): 7.00 mm	Kürzbarer Schaft/ Shortable shaft
	RU 7950-41/01	Ø 0,50 mm
	RU 7950-41/02	Ø 0,60 mm
	RU 7950-41/03	Ø 0,40 mm
	RU 7950-41/04	Ø 0,80 mm

* auch ohne Einkerbung unter **RU 7950-41/11 bis/14** verfügbar
* also available without notch under **RU 7950-41/11 to/14**

Prothesen nicht in allen Ländern verfügbar/Prostheses not available in all countries

PARTIELLE UND TOTALE PROTHESEN PARTIAL AND TOTAL PROSTHESES

Audio-PE® Offset Partial Prosthesis

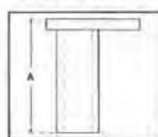

	Länge/Length(A)
RU 7950-50/01	5,00 mm
Columella	
AD/OD:	Ø 1,80 mm

Audio-PE® Offset Total Prosthesis

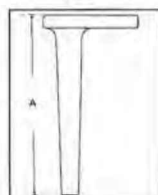

	Länge/Length(A)
RU 7950-51/01	6,00 mm
RU 7950-51/02	7,00 mm
RU 7950-51/03	8,00 mm
Columella	
distales Ende/distal end:	Ø 0.65 mm

Audio-PE® Total Prosthesis

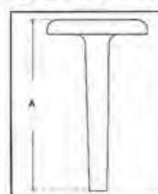

	Länge/Length(A)
RU 7950-52/01	6,00 mm
RU 7950-52/02	7,00 mm
RU 7950-52/03	8,00 mm
Columella	
distales Ende/distal end:	Ø 0.70 mm

Audio-PE® Partial Prosthesis

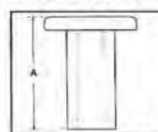

	Länge/Length(A)
RU 7950-53/01	5,00 mm
Columella	
AD/OD:	Ø 2,10 mm

Audio-PE® Adjustable Offset Total Prosthesis

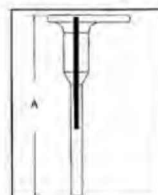

	Länge/Length(A)
RU 7950-54/01	8,00 mm
Columella	
distales Ende/distal end:	Ø 0,65 mm

AUDIOLITE® Offset Total Prosthesis

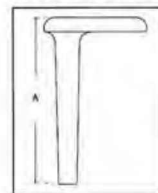

	Länge/Length(A)
RU 7950-55/01	5,00 mm
RU 7950-55/02	5,50 mm
RU 7950-55/03	6,00 mm
RU 7950-55/04	6,50 mm
RU 7950-55/05	7,00 mm
RU 7950-55/06	7,50 mm
RU 7950-55/07	8,00 mm
Columella	
distales Ende/distal end:	Ø 0.65 mm

AUDIOLITE® Offset Partial Prosthesis

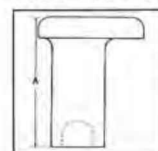

	Länge/Length(A)
RU 7950-56/01	3,00 mm
RU 7950-56/02	3,50 mm
RU 7950-56/03	4,00 mm
RU 7950-56/04	4,50 mm
RU 7950-56/05	5,00 mm
RU 7950-56/06	5,50 mm
Columella AD/OD:	Ø 2.10 mm

AUDIOLITE® Total Prosthesis

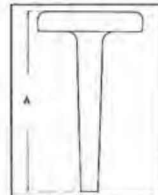

	Länge/Length(A)
RU 7950-57/01	5,00 mm
RU 7950-57/02	5,50 mm
RU 7950-57/03	6,00 mm
RU 7950-57/04	6,50 mm
RU 7950-57/05	7,00 mm
RU 7950-57/06	7,50 mm
RU 7950-57/07	8,00 mm
Columella	
distales Ende/distal end:	Ø 0.65 mm

AUDIOLITE® Partial Prosthesis

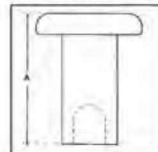

	Länge/Length(A)
RU 7950-58/01	3,00 mm
RU 7950-58/02	3,50 mm
RU 7950-58/03	4,00 mm
RU 7950-58/04	4,50 mm
RU 7950-58/05	5,00 mm
Columella AD/OD:	Ø 2.10 mm

AUDIOLITE® 90° Oval Head Total Prosthesis

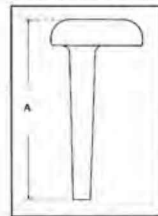

	Länge/Length(A)
RU 7950-59/01	5,00 mm
RU 7950-59/02	5,50 mm
RU 7950-59/03	6,00 mm
RU 7950-59/04	6,50 mm
RU 7950-59/05	7,00 mm
RU 7950-59/06	7,50 mm
RU 7950-59/07	8,00 mm
Columella	
distales Ende/distal end:	Ø 0.70 mm

AUDIOLITE® 75° Oval Head Total Prosthesis

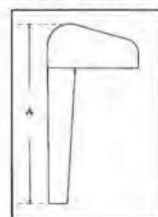

	Länge/Length(A)
RU 7950-60/01	5,00 mm
RU 7950-60/02	5,50 mm
RU 7950-60/03	6,00 mm
RU 7950-60/04	6,50 mm
RU 7950-60/05	7,00 mm
RU 7950-60/06	7,50 mm
RU 7950-60/07	8,00 mm
Columella	
distales Ende/distal end:	Ø 0.70 mm

AUDIOLITE® 90° Oval Head Partial Prosthesis

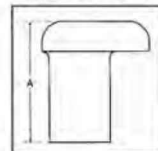

	Länge/Length(A)
RU 7950-61/01	3,00 mm
RU 7950-61/02	3,50 mm
RU 7950-61/03	4,00 mm
RU 7950-61/04	4,50 mm
RU 7950-61/05	5,00 mm
Columella AD/OD:	Ø 2.10 mm

AUDIOLITE® 75° Oval Head Partial Prosthesis

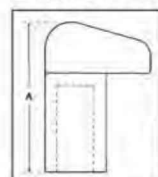

	Länge/Length(A)
RU 7950-62/01	3,00 mm
RU 7950-62/02	3,50 mm
RU 7950-62/03	4,00 mm
RU 7950-62/04	4,50 mm
RU 7950-62/05	5,00 mm
Columella AD/OD:	Ø 2.10 mm

AUDIOLITE® Partial Incus

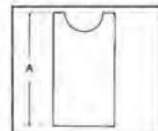

	Länge/Length(A)
RU 7950-63/01	3,25 mm
RU 7950-63/02	3,75 mm
Columella AD/OD:	Ø 2.10 mm

Prothesen nicht in allen Ländern verfügbar/Prostheses not available in all countries

**PARTIELLE UND TOTALE PROTHESEN
PARTIAL AND TOTAL PROSTHESES**

AUDIOLITE® PARTIAL INCUS

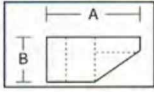

	Länge/Length
RU 7950-70/01	(A) 2,50 mm (B) 1,60 mm

AUDIOLITE® Adjustable Total Prosthesis

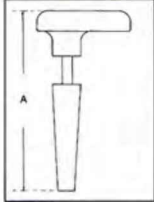

	Länge/Length(A)
RU 7950-71/01	5,50 mm
RU 7950-71/02	6,00 mm
RU 7950-71/03	6,50 mm
RU 7950-71/04	7,00 mm
RU 7950-71/05	7,50 mm
RU 7950-71/06	8,00 mm

Columella
distales Ende/distal end: Ø 0,65 mm

AUDIOLITE® Adjustable Partial Prosthesis

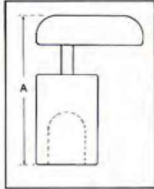

	Länge/Length(A)
RU 7950-72/01	3,50 mm
RU 7950-72/02	4,00 mm
RU 7950-72/03	4,50 mm
RU 7950-72/04	5,00 mm
RU 7950-72/05	5,50 mm
RU 7950-72/06	6,00 mm

Columella AD/OD: Ø 2,10 mm

Porous and Dense AUDIOLITE® Total Prosthesis

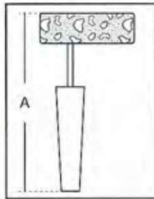

	Länge/Length(A)
RU 7950-73/01	5,50 mm
RU 7950-73/02	6,00 mm
RU 7950-73/03	6,50 mm
RU 7950-73/04	7,00 mm
RU 7950-73/05	7,50 mm
RU 7950-73/06	8,00 mm

Columella
unteres Ende/Lower end: Ø 0,65 mm

Porous and Dense AUDIOLITE® Partial Prosthesis

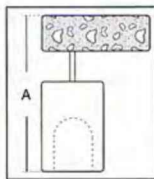

	Länge/Length(A)
RU 7950-74/01	4,00 mm
RU 7950-74/02	4,50 mm
RU 7950-74/03	5,00 mm
RU 7950-74/04	5,50 mm
RU 7950-74/05	6,00 mm

Columella AD/OD: Ø 2,10 mm

**Porous AUDIOLITE® and PTFE
Adjustable Total Prosthesis**

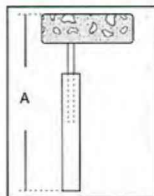

RU 7950-75/01	Gesamtlänge/Total length (A): 8,00 mm kürzbar auf/shortable to: 3,25 mm Flansch/Flange: Ø 3,50 mm Platin/Platinum: Ø 0,20 mm PTFE: Ø 0,60 mm
----------------------	--

**Porous AUDIOLITE® and PTFE
Adjustable Partial Prosthesis**

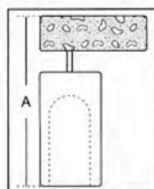

RU 7950-76/01	Gesamtlänge/Total length (A): 6,50 mm kürzbar auf/shortable to: 3,00 mm Flansch/Flange: Ø 3,50 mm Platin/Platinum: Ø 0,25 mm PTFE Columella AD/OD: Ø 2,10 mm
----------------------	--

Porous AUDIOLITE® and AUDIO-PE® Adjustable Total Prosthesis

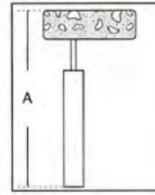

RU 7950-77/01	Gesamtlänge/Total length (A): 8,00 mm kürzbar auf/shortable to: 3,25 mm Flansch/Flange: Ø 3,50 mm Platin/Platinum: Ø 0,20 mm Audio-PE: Ø 0,75 mm
----------------------	--

Porous AUDIOLITE® and AUDIO-PE® Adjustable Partial Prosthesis

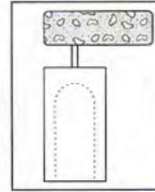

RU 7950-78/01	Gesamtlänge/Total length: 6,50 mm kürzbar auf/shortable to: 3,00 mm Flansch/Flange: Ø 3,50 mm Platin/Platinum: Ø 0,25 mm Audio-PE Columella AD/OD: Ø 2,10 mm
----------------------	--

Universal Adjustable Prosthesis

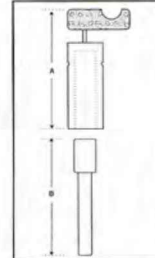

RU 7950-79/01	Partiell/Partial: Gesamtlänge/Total length: 6,50 mm kürzbar auf/shortable to: 3,50 mm Ext. Columella: Ø 2,10 mm Inn. Columella: Ø 1,40 mm
	Total/Total: Gesamtlänge/Total length: 10,50 mm kürzbar auf/shortable to: 6,00 mm Columella: Ø 0,80 mm Flansch/Flange: Ø 3,50 mm Platin/Platinum: Ø 0,20 mm

AUDIOLITE® Telescopic Total Prosthesis by Magnan-Babighian

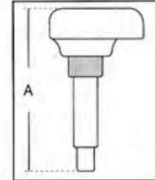

	Länge/Length (A) mm
RU 7950-80/01	5,00 min/5,70 max
RU 7950-80/02	5,50 min/6,20 max
RU 7950-80/03	6,00 min/6,70 max
RU 7950-80/04	6,50 min/7,20 max
RU 7950-80/05	7,00 min/7,70 max
RU 7950-80/06	7,50 min/8,20 max
RU 7950-80/07	8,00 min/8,70 max

Kolben/Piston Ø 0,80 mm

AUDIOLITE® Telescopic Partial Prosthesis by Magnan-Babighian

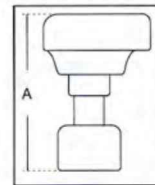

	Länge/Length (A) mm
RU 7950-81/01	3,50 min/4,20 max
RU 7950-81/02	4,00 min/4,70 max
RU 7950-81/03	4,50 min/5,20 max
RU 7950-81/04	5,00 min/5,70 max
RU 7950-81/05	5,50 min/6,20 max
RU 7950-81/06	6,00 min/6,70 max

Columella AD/OD: Ø 2,10 mm

POROUS AUDIOLITE® Posterior Canal Wall by Magnan

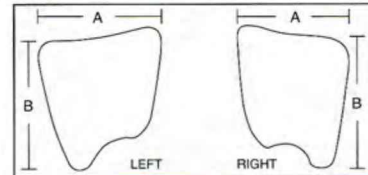

RU 7950-82/01	Breite/Width (A): 20 mm Länge/Length (B): 22 mm A-Radius/O Radius: 10 mm IR/IR: 6 mm
----------------------	---

AUDIOLITE® and Audio-PE® Adjustable Total Prosthesis

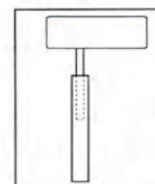

RU 7950-83/01	Gesamtlänge/Total length: 8,00 mm Flansch/Flange: Ø 3,50 mm Platin/Platinum: Ø 0,20 mm Audio-PE: Ø 0,75 mm
----------------------	---

PARTIELLE UND TOTALE PROTHESEN PARTIAL AND TOTAL PROSTHESES

AUDIOLITE® and Audio-PE® Adjustable Partial Prosthesis

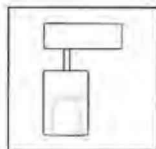

RU 7950-90/01

Gesamtlänge/Total length: 6,50 mm
 Flansch/Flange: Ø 3,50 mm
 Platin/Platinum: Ø 0,25 mm
 Audio-PE Columella: Ø 2,20 mm
 AD/OD: Ø 2,20 mm

AUDIOLITE® Prosthesis „Marpla“ by E. Garcia Ibañez

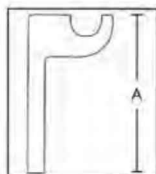

RU 7950-90/02

Gesamtlänge/Total length: 7,50 mm
 Flanschlänge/Flange length: 4,00 mm
 Columella Breite/Width: 1,0 x 0,8 mm

AUDIOLITE® and Audio-PE® Adjustable Malleus - Stapes Prosthesis

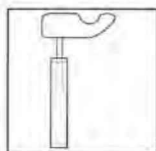

RU 7950-90/03

Gesamtlänge/Total length: 8,00 mm
 Flansch/Flange: Ø 3,50 mm
 Platin/Platinum: Ø 0,20 mm
 Audio-PE: Ø 0,75 mm

AUDIOLITE® and Audio-PE® Adjustable Malleus - Footplate Prosthesis



RU 7950-90/04

Gesamtlänge/Total length: 6,50 mm
 Flansch/Flange: Ø 3,50 mm
 Platin/Platinum: Ø 0,25 mm
 Audio-PE Columella: Ø 2,20 mm
 AD/OD: Ø 2,20 mm

AUDIOLITE® Footplate Prosthesis

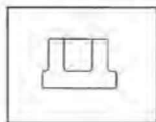

RU 7950-90/05

Fußplatte/Footplate: 2,1 x 1,5 mm
 ID: Ø 0,80 mm
 Sockelhöhe/
 Added implant length: 0,50 mm

AUDIOLITE® Open - Tympanoplasty Prosthesis

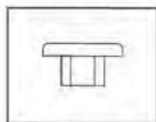

RU 7950-90/06

Hohl/Cannulated
 Gesamtlänge/Total length: 3,50 mm
 Flansch/Flange: Ø 3,20 mm
 ID: Ø 1,20 mm

Porous AUDIOLITE® Partial Prosthesis



RU 7950-90/07

Gesamtlänge/Total length: 4,00 mm
 Flansch/Flange: Ø 4,00 mm
 Columella AD/OD: Ø 2,10 mm
 Columella ID/ID: Ø 1,20 mm

AUDIOLITE®
POROUS AUDIOLITE®
AUDIO-PE®
AUDIO-PTFE®

Bioaktives Kalziumhydroxylapatit
 Bioaktives Kalziumhydroxylapatit (porös)
 UHMWPE (porös)
 Polytetrafluorethylen

GOLD and AUDIO-PTFE® Adjustable Total Prosthesis

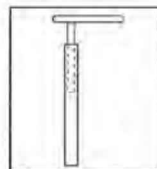

RU 7950-90/08

Gesamtlänge/Total length: 8,00 mm
 kürzbar auf/Shortable to: 4,50 mm
 Flansch/Flange: Ø 2,80 mm
 Gold-Draht/Gold wire: Ø 0,30 mm
 Audio-PTFE: Ø 0,80 mm

GOLD and AUDIO-PE® Adjustable Partial Prosthesis

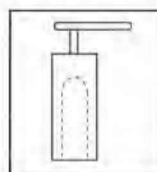

RU 7950-90/09

Gesamtlänge/Total length: 6,50 mm
 kürzbar auf/Shortable to: 2,75 mm
 Flansch/Flange: Ø 2,80 mm
 Gold-Draht/Gold wire: Ø 0,30 mm
 Audio-PE Columella AD/OD: Ø 1,80 mm
 Audio-PE Columella ID/ID: Ø 1,20 mm

GOLD and AUDIO-PTFE® Adjustable Total Prosthesis

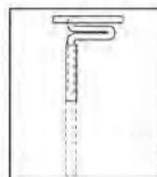

RU 7950-90/10

Gesamtlänge/Total length: 4,00 mm
 Erweiterung auf/Extension to: 9,00 mm
 Flansch/Flange: Ø 2,80 mm
 Gold-Draht/Gold wire: Ø 0,30 mm
 Audio-PTFE: Ø 0,80 mm

GOLD and AUDIO-PE® Adjustable Partial Prosthesis



RU 7950-90/11

Gesamtlänge/Total length: 2,75 mm
 Erweiterung auf/Extension to: 6,50 mm
 Flansch/Flange: Ø 3,00 mm
 Audio-PE Columella AD/OD: Ø 1,80 mm
 Audio-PE Columella ID/ID: Ø 1,20 mm

PLATINUM and PTFE® Total Prosthesis for Tympanoplasty

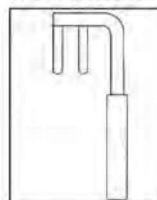

RU 7950-90/12

Gesamtlänge/Total length: 6,25 mm
 kürzbar auf/Shortable to: 4,50 mm
 Platin-Draht/Platinum wire: Ø 0,30 mm
 Platin-Clips/Platinum clips: ± 0,20 mm
 PTFE: Ø 0,60 mm

PLATINUM Partial Prosthesis for Tympanoplasty

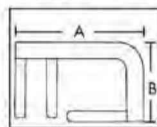

RU 7950-90/13

Länge/Length (A): 2,70 mm
 Länge/Length (B): 1,50 mm
 Platin-Draht/Platinum wire: Ø 0,30 mm
 Platin-Clips/Platinum clips: ± 0,20 mm

Bioactive calciumhydroxyapatite
 Bioactive calciumhydroxyapatite (porous)
 UHMWPE (porous)
 Polytetrafluorethylen (teflon)

Prothesen nicht in allen Ländern verfügbar/Prostheses not available in all countries

INSTRUMENTENSÄTZE STAPEDOTOMIE / STAPEDEKTOMIE INSTRUMENT SETS FOR STAPEDOTOMY / STAPEDECTOMY

Instrumente für die Stapedektomie *Instruments for stapedectomy*



RU 7951-01

Das Set besteht aus 14 Instrumenten (17 cm) für die Stapedektomie

The kit includes 14 instruments (6¾") for stapedectomy.

RU 7951-20 bis RU 7951-32 +
RU 7893-14 in Tray **RU 7951-11**

Instrumente für die Stapedotomie *Instruments for stapedotomy*



RU 7951-02

Das Set besteht aus 14 Instrumenten für die Stapedektomie und 6 Instrumenten (Perforatoren) für die Stapedotomie (17 cm)

This kit includes 14 instruments for stapedectomy and 6 instruments (Perforators) for stapedotomy (6¾")

RU 7951-20 bis RU 7951-45 +
RU 7893-14 in Tray **RU 7951-12**

	RU 7951-20	Chirurgisches Messer für Ohrkanal-Inzisionen <i>Surgical knife for ear canal incisions</i>
	RU 7951-21	Longitudinal-Messer für Ohrkanal <i>Longitudinal knife for ear canal</i>
	RU 7951-22	Rundmesser, gewinkelt <i>Decollator, angled, Ø 1.70 mm</i>
	RU 7951-23	Rundmesser, klein, gewinkelt <i>Decollator, small, angled, Ø 1.70 mm, 135°</i>
	RU 7951-24	Venen-Dissektor, kugelförmig, <i>Vein dissector, ball-shaped, 1.0x0.65 mm</i>
	RU 7951-25	Haken, groß <i>Hook, large, 2.0 mm/0.35 mm</i>
	RU 7951-26	Exartikulations-Instrument, scharf, <i>Disarticulation instrument, sharp edges</i>
	RU 7951-27	Nadel, gerade, gewinkelt <i>Needle, straight, angled, Ø 0.5 mm, 1 mm</i>
	RU 7951-28	Mikro-Haken <i>Micro hook, 0.35 mm, 0.10 mm</i>
	RU 7951-29	Elevator, flach, scharf, vorwärts schneidend <i>Elevator, flat, sharp, forwards, 0.5/0.15 mm</i>
	RU 7951-30	Elevator, flach, scharf, rückwärts schneidend <i>Elevator, flat, sharp, backward, 0.5/0.15 mm</i>
	RU 7951-31	Kürette, scharf, klein <i>Curette, sharp, small, 2.4x1.6 mm</i>
	RU 7951-32	Kürette, scharf, groß <i>Curette, sharp, large, 3.0x2.0 mm</i>
	RU 7893-14	Mikrochirurgisches Messinstrument <i>Microsurgical measuring device, 19 cm/7½"</i>
	RU 7951-40	Perforator, 1.0 mm, Ø 0.3 mm
	RU 7951-41	Perforator, 1.0 mm, Ø 0.4 mm
	RU 7951-42	Perforator, 1.0 mm, Ø 0.5 mm
	RU 7951-43	Perforator, 1.0 mm, Ø 0.6 mm
	RU 7951-44	Perforator, 1.0 mm, Ø 0.7 mm
	RU 7951-45	Perforator, 1.0 mm, Ø 0.9 mm

Alle Instrumente sind gemäß ihrer Position im Kit nummeriert. Eine vergrößerte Abbildung der Instrumenten-spitzen erleichtert deren Handhabung. Der sichere Transport sowie die Sterilisation werden durch den bayonettartigen Einsatz, welcher die Instrumente fixiert, gewährleistet. Autoklavierbarer, säurebeständiger Container aus eloxiertem Aluminium und rostfreiem Stahl.

Each instrument is marked with the number corresponding to its position in the container. On the tip protection band, a silkscreened enlargement of the tip of the instrument is clearly visible, permitting easy identification of each instrument. For transport and sterilization, a cover with a bayonet insertion closes the box, locking the instruments in place and protecting them against damage.

Dry-sterilizable, acid resistant container, made of anodized aluminum and stainless steel.

- ✓ X30 oder 13 rostfreier Stahl
- ✓ Vakuum-wärmebehandelt
- ✓ Patentierte, nicht reflektierende Oberfläche
- ✓ Handgearbeitet unter mikroskopischer Sicht

- ✓ X30 or 13 stainless steel
- ✓ Vacuum heat treatment
- ✓ Patented non-reflective surface
- ✓ Handmade under microscope

**MIKRO-ZANGEN UND -SCHEREN
MICRO-FORCEPS AND -SCISSORS**

Schaft Ø 0,9 mm
Shaft Ø 0,9 mm



**Mikro-Zangen
Micro-Forceps**

		4 mm		6 mm
gerade straight	Schaftlänge length of shaft	8 cm/3¼"	RU 7894-01 RU 7894-01/16	RU 7894-03 RU 7894-03/16
aufgebogen angled up		8 cm 16 cm	RU 7894-02 RU 7894-02/16	

**Löffelzangen
Cup-shaped forceps**

gerade straight			oval oval cup jaws	
	Ø 1 mm	8 cm 16 cm	RU 7894-11 RU 7894-11/16	RU 7894-12 RU 7894-12/16
	Ø 2,5 mm	16 cm	RU 7894-13/16	

**Mikro-Scheren
Micro scissors**

gerade straight		8 cm/3¼"	RU 7894-21 RU 7894-21/16
aufgebogen angled up		8 cm/3¼"	RU 7894-22 RU 7894-22/16
rechts gebogen curved right		8 cm/3¼"	RU 7894-23 RU 7894-23/16
links gebogen curved left		8 cm/3¼"	RU 7894-24 RU 7894-24/16

**Pinzettenzängchen Heermann
Finest grasping forceps**

gerade straight		8 cm/3¼"	RU 7894-31
rechts gebogen curved right		8 cm/3¼"	RU 7894-33
links gebogen curved left		8 cm/3¼"	RU 7894-34
horizontal horizontal		8 cm/3¼"	RU 7894-35

MIKRO-SCHEREN, -STANZEN, -ZÄNGCHEN
MICRO-SCISSORS, -NIPPERS, -FORCEPS

Schaft Ø 1,5 mm
Shaft Ø 1.5 mm

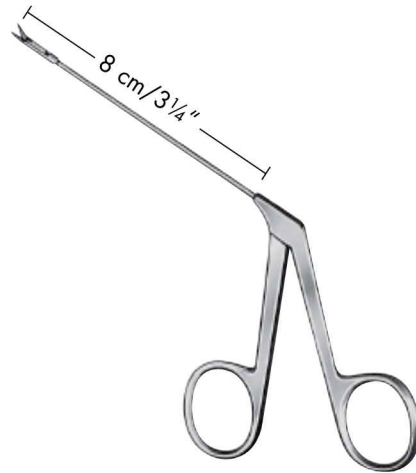

Mikroscheren
Micro-scissors

gerade, spitz/spitz
straight, sharp/sharp



RU 7894-60/01

aufgebogen, stumpf/stumpf
angled up, blunt/blunt



RU 7894-60/02

links gebogen, spitz/spitz
curved left, sharp/sharp



RU 7894-60/03

rechts gebogen, spitz/spitz
curved right, sharp/sharp



RU 7894-60/04

horizontal schneidend
horizontal cutting



RU 7894-60/05

Mikrostanzen
Micro-Nippers

nach oben schneidend
upwards cutting



RU 7894-60/10

nach unten schneidend
downwards cutting



RU 7894-60/11

Mikro-Drahtbiegezängchen
Micro wire bending forceps

nach unten gebogen
curved down



RU 7894-60/15

nach unten gebogen
curved down



RU 7894-60/16

**MIKRO-LÖFFELZÄNGCHEN
MICRO-CUP-SHAPED FORCEPS**

Schaft Ø 1,5 mm
Shaft Ø 1.5 mm

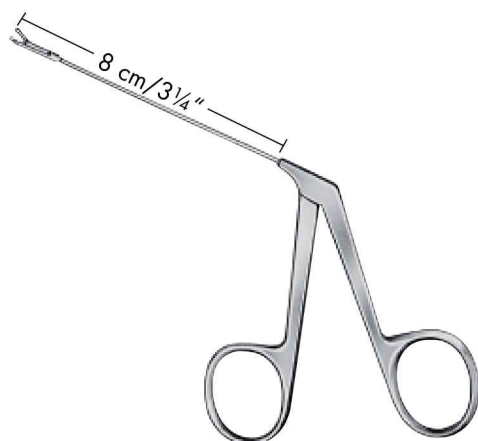

gerade, oval,
straight, oval
0,9 x 1,0 mm



RU 7894-61/01

aufgebogen, oval
angled up, oval
0,9 x 1,0 mm



RU 7894-61/02

gerade, oval,
straight, oval
0,8 x 1,3 mm



RU 7894-61/06

links gebogen, oval
curved left, oval
0,8 x 1,3 mm



RU 7894-61/07

rechts gebogen, oval
curved right, oval
0,8 x 1,3 mm



RU 7894-61/08

gerade, rund
straight, round
Ø 1,0 mm

Wullstein



RU 7894-61/12

gerade, oval,
straight, oval
1,7 x 2,5 mm

Wullstein



RU 7894-61/16

MIKRO-ZÄNGCHEN
MICRO-FORCEPS

Schaft Ø 1,5 mm
Shaft Ø 1.5 mm



gerade
straight
0,8 x 3,5 mm



RU 7894-62/01

gerade
straight
1 x 5 mm



RU 7894-62/08

65° nach oben
curved up 65°
0,8 x 3,5 mm



RU 7894-62/02

links gebogen
curved left
1 x 5 mm



RU 7894-62/09

45° nach unten
curved down 45°
0,8 x 3,5 mm



RU 7894-62/03

rechts gebogen
curved right
1 x 5 mm



RU 7894-62/10

gerade
straight
1,5 x 6 mm



RU 7894-62/14

**MIKRO-SCHEREN UND -ZANGEN
MICRO-SCISSORS AND -FORCEPS**

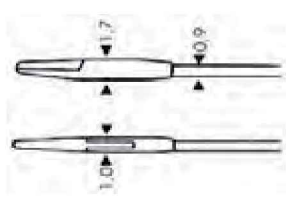

Schaft Ø 0,9 mm
Shaft Ø 0.9 mm

aufgebogen
angled up

gerade
straight



RU 8860-01

RU 8860-02

Mikro-Scheren
Micro scissors



RU 8861-01

RU 8861-02

Mikro-Zangen
Micro forceps



RU 8862-01

RU 8862-02

Löffelzangen
Cup-shaped forceps

MIKROCHIRURGIE – MESSER
MICROSURGERY KNIVES



Rollmesser
parallel zum Schaft
Roller knife
blade parallel to shaft

Rollmesser
rechtwinklig zum Schaft
Roller knife
blade right angled to shaft



Schuhknecht
16 cm/6¼"

RU 7906-01/01

Schuhknecht
16 cm/6¼"

RU 7906-01/02



Schuhknecht
16 cm/6¼"

RU 7906-01/03



Wullstein
16 cm/6¼"

RU 7906-01/04



Tabb
16 cm/6¼"

RU 7906-01/05

MIKROCHIRURGIE – MESSER
MICROSURGERY KNIVES

3,5 x 2,5 mm



Plester
RU 7906-01/06

4,0 x 2,0 mm



Plester
RU 7906-01/07

4,5 x 2,5 mm



Plester
RU 7906-01/08



Plester
16 cm/6¼"



RU 7906-02/01

mittlere Biegung
medium curved



RU 7906-02/02

stark gebogen
strongly curved



Plester
RU 7906-02/03



Plester
RU 7906-02/04

MIKROCHIRURGIE – MESSER
MICROSURGERY KNIVES

45°



Ø	
1,0 mm	RU 7906-03/10
1,4 mm	RU 7906-03/14
1,6 mm	RU 7906-03/16
2,0 mm	RU 7906-03/20
2,3 mm	RU 7906-03/23
2,6 mm	RU 7906-03/26
2,8 mm	RU 7906-03/28
3,0 mm	RU 7906-03/30

Rosen

16 cm/6¼"

0°



Ø	
1,0 mm	RU 7906-04/10
1,5 mm	RU 7906-04/15
2,0 mm	RU 7906-04/20
2,3 mm	RU 7906-04/23
2,5 mm	RU 7906-04/25

16 cm/6¼"

90°



Ø	
1,0 mm	RU 7906-05/10
1,5 mm	RU 7906-05/15
2,0 mm	RU 7906-05/20
2,3 mm	RU 7906-05/23
2,5 mm	RU 7906-05/25

16 cm/6¼"

MIKROCHIRURGIE – MESSER
MICROSURGERY KNIVES



16 cm/6¼"
RU 7906-06/30
Rundschnittmesser für Periost
Round cutting knife for periost



Rosen
16 cm/6¼"
RU 7906-07/16
Lanzettenmesser
Lancet knife



Beales
17 cm/6¾"
RU 7906-08/17
Sehnenmesser
Tendon knife



Fisch
16 cm/6¼"
RU 7906-09/16
Neurektomie-Messer
Neurectomy knife



Fisch
16 cm/6¼"
RU 7906-10/16
Tenotom
Tenotome

MIKROCHIRURGIE – NADELN UND -HÄKCHEN
MICROSURGERY – NEEDLES AND HOOKS



16 cm/6¼"



Barbara
RU 7907-01/01



RU 7907-01/02



RU 7907-01/03



Rosen
RU 7907-01/04



Fisch
0,2 mm
RU 7907-02/02

Plester
0,6 mm
RU 7907-02/06



Shambaugh
25°

- 0,3 mm **RU 7907-03/03**
- 0,6 mm **RU 7907-03/06**
- 1,0 mm **RU 7907-03/10**



Shambaugh
45°

- 0,3 mm **RU 7907-04/03**
- 0,4 mm **RU 7907-04/04**
- 0,6 mm **RU 7907-04/06**
- 0,8 mm **RU 7907-04/08**
- 1,0 mm **RU 7907-04/10**
- 1,2 mm **RU 7907-04/12**
- 1,5 mm **RU 7907-04/15**
- 2,0 mm **RU 7907-04/20**
- 2,5 mm **RU 7907-04/25**



Shambaugh
90°

- 0,3 mm **RU 7907-05/03**
- 0,4 mm **RU 7907-05/04**
- 0,6 mm **RU 7907-05/06**
- 0,8 mm **RU 7907-05/08**
- 1,0 mm **RU 7907-05/10**
- 1,2 mm **RU 7907-05/12**
- 1,5 mm **RU 7907-05/15**
- 2,0 mm **RU 7907-05/20**
- 2,5 mm **RU 7907-05/25**



- 0,5 mm **RU 7907-06/05**
- 1,0 mm **RU 7907-06/10**

MIKROCHIRURGIE – NADELN UND -HÄKCHEN
MICROSURGERY – NEEDLES AND HOOKS

2:1



16 cm/6¼"
RU 7907-07/16

2:1



Fisch

16 cm/6¼"
Ø 0,3 mm **RU 7907-08/03**
Ø 0,4 mm **RU 7907-08/04**
Ø 0,5 mm **RU 7907-08/05**
Ø 0,6 mm **RU 7907-08/06**

Perforator
Perforator

2:1
45°



Plester

16 cm/6¼"
RU 7907-09/45

2:1
90°



Plester

16 cm/6¼"
RU 7907-09/90
Kieferhöhlenhäkchen
Antrum hook



16 cm/6¼"



90°

0,3 mm **RU 7907-10/03**
0,6 mm **RU 7907-10/06**
1,0 mm **RU 7907-10/10**



90°

0,3 mm **RU 7907-11/03**
0,6 mm **RU 7907-11/06**
1,0 mm **RU 7907-11/10**



McGee

0,5 mm **RU 7907-12/05**
1,0 mm **RU 7907-12/10**



McGee

0,5 mm **RU 7907-13/05**
1,0 mm **RU 7907-13/10**

MIKROCHIRURGIE – NADELN UND -HÄKCHEN
MICROSURGERY – NEEDLES AND HOOKS



16 cm/6¼"



Barbara
RU 7907-15/01



Rosen
RU 7907-16/01



25°

0,3 mm **RU 7907-18/03**
0,6 mm **RU 7907-18/06**
1,0 mm **RU 7907-18/10**



25°

0,3 mm **RU 7907-19/03**
0,6 mm **RU 7907-19/06**
1,0 mm **RU 7907-19/10**



45°

0,3 mm **RU 7907-20/03**
0,6 mm **RU 7907-20/06**
1,0 mm **RU 7907-20/10**



45°

0,3 mm **RU 7907-21/03**
0,6 mm **RU 7907-21/06**
1,0 mm **RU 7907-21/10**

MIKROCHIRURGIE – DIVERSES INSTRUMENTARIUM
MICROSURGERY – VARIOUS INSTRUMENTS



Fisch
16 cm/6¼
Dissektoren
Excavators



RU 7908-01/01



RU 7908-01/02



RU 7908-01/03



RU 7908-01/04



Rosen
19 cm/7¼
1,5 mm 2,5 mm
RU 7908-02/15 **RU 7908-02/25**
Raspatorien
Raspatories



Rosen
16 cm/6¼



RU 7908-04/01



RU 7908-04/02



RU 7908-04/03



RU 7908-04/04



RU 7908-04/05



RU 7908-04/06



House
16 cm/6¼"
Mess-Sonden
Measuring rods



3,5 mm
RU 7908-06/35



4,0 mm
RU 7908-06/40



4,5 mm
RU 7908-06/45



5,0 mm
RU 7908-06/50

MIKROCHIRURGIE – DIVERSES INSTRUMENTARIUM
MICROSURGERY – VARIOUS INSTRUMENTS



16 cm/6¼"
RU 7908-07/16

Mess-Sonde
Measuring rod



Plester
15,5 cm/6"
RU 7908-08/02



Fisch
16,5 cm/6½"
RU 7908-10/16

Messinstrument
Measuring instrument



Fisch
16,5 cm/6½"
Ø 0,4 mm **RU 7908-12/04**
Ø 0,6 mm **RU 7908-12/06**
Ø 0,8 mm **RU 7908-12/08**

Messzylinder
Measuring cylinder



Plester
16 cm/6¼"
RU 7908-14/02

Schaber
Scraper



Plester
16 cm/6¼"
RU 7908-16/16

Führungsgabel
Wire guide



Hughes
16,5 cm/6½"
RU 7908-18/16

Steigbügelhäkchen
Stapes mobilizer



16 cm/6¼"
RU 7908-20/02
Transplantat-Träger/Raspatorium
Graft holder/elevator



16 cm/6¼"
RU 7908-22/01

Dissektor links
Excavator left



16 cm/6¼"
RU 7908-22/02

Dissektor rechts
Excavator right

MIKROCHIRURGIE – DIVERSES INSTRUMENTARIUM
MICRO SURGERY – VARIOUS INSTRUMENTS



92 x 54 mm
RU 7908-24/01
Präpariertablett aus Metall
Preparation tray of metal



Regensburg
16 cm/6¼"
RU 7908-26/03
Spiegel/Mirrors



Höhmann
16 cm/6¼"
RU 7908-30/25



16 cm/6¼"
RU 7908-32/01
Elevatorium/Elevator



16 cm/6¼"
RU 7908-34/18
Raspatorium/Raspator



Beales
16 cm/6¼"
RU 7908-38/16



Wullstein
16 cm/6¼"
RU 7908-40/32
Raspatorien/Raspatories

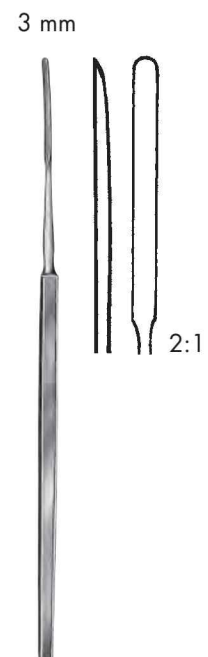

Lempert
16 cm/6¼"
RU 7908-42/30

MIKROCHIRURGIE – DIVERSES INSTRUMENTARIUM
MICROSURGERY – VARIOUS INSTRUMENTS



16 cm/6¼"
Buckingham



RU 7909-01/01



RU 7909-01/02



RU 7909-01/03



17 cm/6¾"
RU 7909-08/00
Stapedektomie-Löffel
Stapedectomy curette



House
15 cm/6¼"
1,0/1,2 mm **RU 7909-10/10**
1,5/1,8 mm **RU 7909-10/15**



House
15 cm/6¼"
1,0/1,2 mm **RU 7909-11/10**
1,5/1,8 mm **RU 7909-11/15**



Shea
12 cm/4¾"
1,5 mm **RU 7909-12/15**

**MIKROCHIRURGIE – DIVERSES INSTRUMENTARIUM
MICROSURGERY – VARIOUS INSTRUMENTS**



RU 7909-30/10
Handgriff für Meißel
Handle for chisels
RU 7909-30/01 - 30/05

0,7 mm



Heermann
9 cm
RU 7909-30/01
Flachmeißel, sehr fein
Chisel, very delicate

0,7 mm



RU 7909-30/02
Hohlmeißel, sehr fein
Gouge, very delicate

1,0 mm



RU 7909-30/03
Hohlmeißel für Fenestration
Gouges for fenestration

1,5 mm



RU 7909-30/04
Hohlmeißel für Fenestration
Gouges for fenestration

3,0 mm



RU 7909-30/05



Schuknecht
RU 7909-30/00
Biegegerät zum Formen von
Stapes-Draht-Prothesen
Wire bending die to pre-form
stainless steel wire



RU 7909-30/20
Stahldraht für Prothesen
Steel wire for protheses
V2A, USP 5/0, 100m



16 x 12 mm



House-Gelfoam
19 cm/7 1/2"
RU 7909-60
Quetschzange
Pressure Forceps

MIKROCHIRURGIE – DIVERSES INSTRUMENTARIUM
MICROSURGERY – VARIOUS INSTRUMENTS

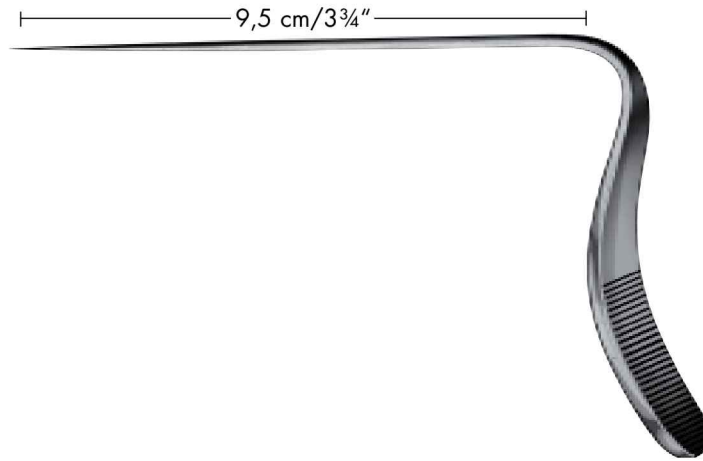

Zöllner
13 cm/5"



2/1

RU 7910-01
Nadel, fein, gerade
Needle, fine, straight



2/1

RU 7910-02
Häkchen, 0,5 mm, 45° nach oben
Hook, 0.5 mm, 45° upwards



2/1

RU 7910-03
Häkchen, 0,5 mm, 45° nach unten
Hook, 0.5 mm, 45° downwards



2/1

RU 7910-04
Häkchen, 0,5 mm, 90° nach oben
Hook, 0.5 mm, 90° upwards



2/1

RU 7910-05
Häkchen, 0,5 mm, 90° nach unten
Hook, 0.5 mm, 90° downwards



2/1

RU 7910-06
Häkchen, 1,0 mm, 45° nach oben
Hook, 1.0 mm, 45° upwards



2/1

RU 7910-07
Häkchen, 1,0 mm, 45° nach unten
Hook, 1.0 mm, 45° downwards



2/1

RU 7910-08
Häkchen, 1,0 mm, 90° nach oben
Hook, 1.0 mm, 90° upwards



2/1

RU 7910-09
Häkchen, 1,0 mm, 90° nach unten
Hook, 1.0 mm, 90° downwards



2/1

RU 7910-10
Häkchen, 2,5 mm, 45° nach oben
Hook, 2.5 mm, 45° upwards



2/1

RU 7910-11
Häkchen, 2,5 mm, 45° nach unten
Hook, 2.5 mm, 45° downwards



2/1











RU 7910-12
Hautmesser, herzförmig, 30° nach oben
Skin knife, heart-shaped, 30° upwards















2/1

RU 7910-13
Hautmesser, herzförmig, 30° nach unten
Skin knife, heart-shaped, 30° downwards

MIKROCHIRURGIE – DIVERSES INSTRUMENTARIUM
MICROSURGERY – VARIOUS INSTRUMENTS

	² / ₁	RU 7910-14 Rundschnittmesser, 90° nach oben <i>Round cutting knife, 90° upwards</i>
	² / ₁	RU 7910-15 Rundschnittmesser, 90° nach unten <i>Round cutting knife, 90° downwards</i>
	² / ₁	RU 7910-16 Sichelmesser, nach oben schneidend <i>Sickle knife, upwards cutting</i>
	² / ₁	RU 7910-17 Sichelmesser, nach unten schneidend <i>Sickle knife, downwards cutting</i>
	² / ₁	RU 7910-18 Lanzettenmesser, nach links gebogen <i>Lancet knife, curved to left side</i>
	² / ₁	RU 7910-19 Lanzettenmesser, nach rechts gebogen <i>Lancet knife, curved to right side</i>
	² / ₁	RU 7910-20 Raspatorium, nach links gebogen <i>Raspatory, curved to left side</i>
	² / ₁	RU 7910-21 Raspatorium, nach rechts gebogen <i>Raspatory, curved to right side</i>
	² / ₁	RU 7910-22 Führungsgabel <i>Wire guide</i>
	² / ₁	RU 7910-23 Mobilisator, nach vorn gebogen <i>Mobilisator, curved forward</i>
	² / ₁	RU 7910-24 Mobilisator, nach hinten gebogen <i>Mobilisator, curved backwards</i>

KÜRETTEN, LÖFFEL, SCHLINGEN
CURETTES, SPOONS, LOOPS

									
		Fig. 000	00	0	1	2	3	4	5
stumpf blunt		RU 7900-30	RU 7900-20	RU 7900-10	RU 7900-01	RU 7900-02	RU 7900-03	RU 7900-04	RU 7900-05
scharf sharp		RU 7902-30	RU 7902-20	RU 7902-10	RU 7902-01	RU 7902-02	RU 7902-03	RU 7902-04	RU 7902-05
stumpf blunt		RU 7903-30	RU 7903-20	RU 7903-10	RU 7903-01	RU 7903-02	RU 7903-03	RU 7903-04	RU 7903-05
scharf sharp		RU 7904-30	RU 7904-20	RU 7904-10	RU 7904-01	RU 7904-02	RU 7904-03	RU 7904-04	RU 7904-05

Buck

16,5 cm/6½"

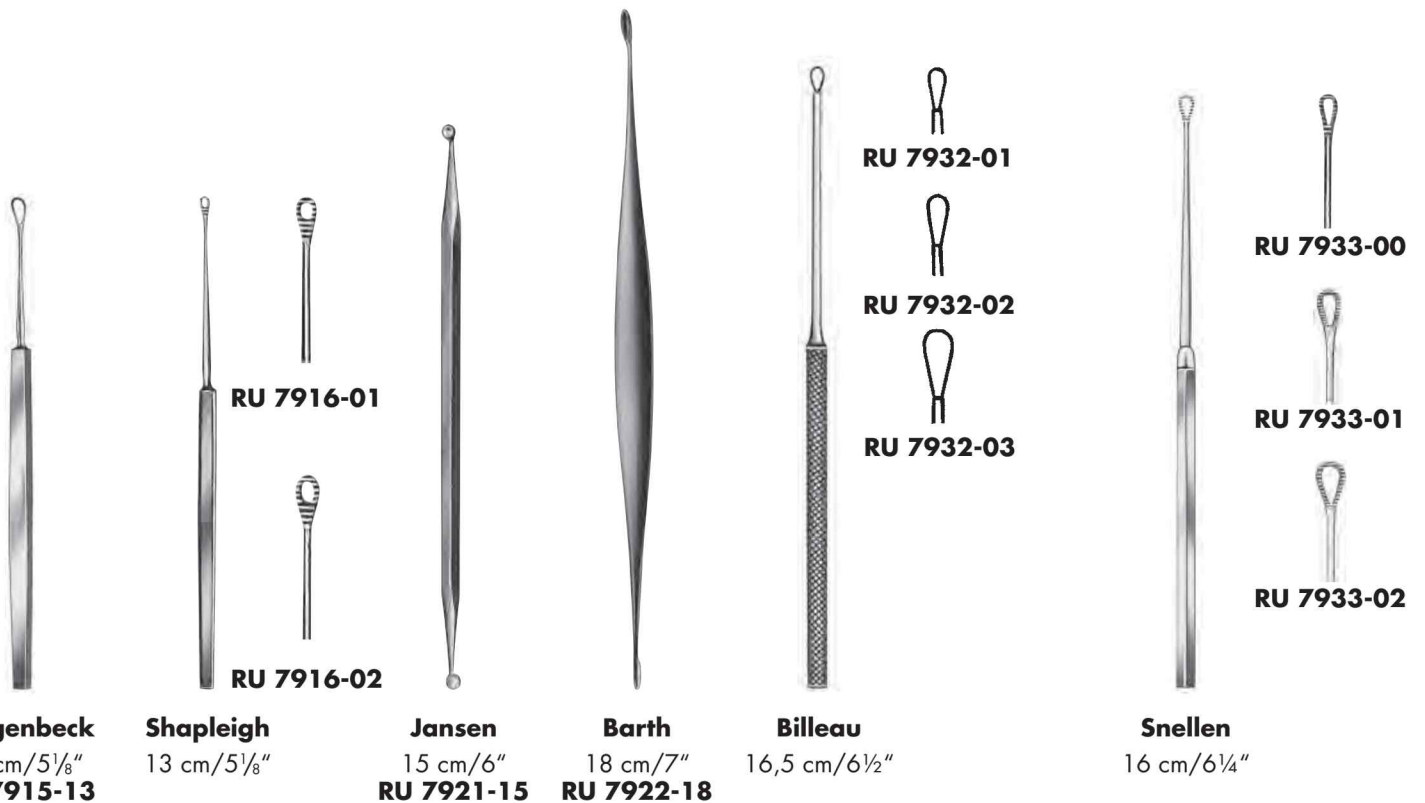

**KÜRETTEN, LÖFFEL, SCHLINGEN, HÄKCHEN
CURETTES, SPOONS, LOOPS, HOOKS**



Gross
12 cm/4³/₄"
RU 7934-01



Formby
18 cm/7"
RU 7935-01



Musgrove
18 cm/7"
RU 7936-01



Bloch
11 cm/4"
RU 7938-11
Fadengabel
Suture pusher



Zaufal
16 cm/6¹/₄"
RU 7939-16
Fremdkörperhebel
Foreign body levers



Hartmann
16 cm/6¹/₄"
RU 7940-16



Lucae
14 cm/5¹/₂"
Knopfhäkchen
Ear hooks,
probe ended

RU 7945-01

RU 7945-02

RU 7945-03



Wagener
14 cm/5¹/₂"
Knopfhäkchen
Ear hooks,
probe ended

RU 7946-01

RU 7946-03

RU 7946-05



RU 7946-02

RU 7946-04

RU 7946-06



15,5 cm/6"
RU 7947-03
Knopfhäkchen
Ear hooks,
probe ended



Day
16 cm/6¹/₄"
Ohrhäkchen
Ear hooks

RU 7949-01

RU 7949-02



Zaufal-Jansen
15 cm/6"
RU 7950-01

**MESSER
KNIVES**



Politzer
16 cm/6¼"
RU 7960-16



Politzer
16 cm/6¼"
RU 7960-16/01



18 cm/7"
gerade
straight

- RU 7962-01
- RU 7962-02
- RU 7962-03



Fig. 17 cm/6¾"
gebogen
curved

- 1 RU 7963-01
- 2 RU 7963-02
- 3 RU 7963-03



Gerzog-Sexton
17 cm/6¾"
RU 7964-17



Politzer
16 cm/6½"
RU 7966-01



Lempert
15 cm/6"
RU 7967-15



Lempert
15 cm/6"



Lempert
15 cm/6"
RU 7968-15



Lempert
15 cm/6"
RU 7970-15

MYRINGOTOME, PARAZENTESENADELN, OHRBESTECK
MYRINGOTOMES, TYMPANUM PERFORATORS, EAR OPERATING SET



Politzer
16,5 cm/6½"
RU 7971-16
Parazentesenadel
Tympanum perforator

Agnew (Poltizer)
17,5 cm/7"
RU 7972-17
Myringotom
Myringotome

Lucae
16 cm/6¼" 18 cm/7"
RU 7974-16 **RU 7974-18**

Lucae
18 cm/7"
RU 7975-18

Parazentesenadeln
Tympanum perforator

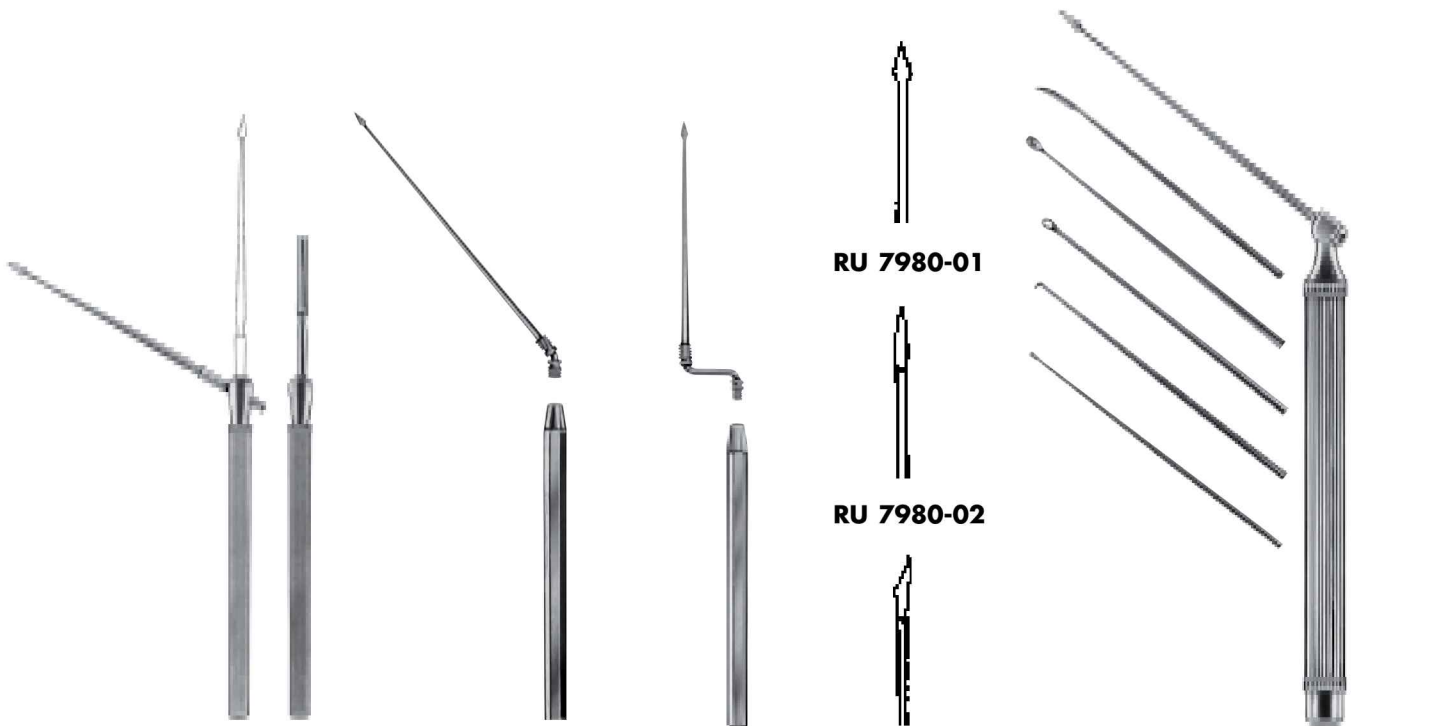

Politzer
17 cm/6¾"
RU 7976-01
Myringotom
Myringotome

16 cm/6¼"
RU 7978-01

16 cm/6¼"

RU 7980-03

Parazentesenadeln
Tympanum perforator

Sprague
19 cm/7½"
RU 7981-00
Ohrbesteck
Ear operating set

**PULVERBLÄSER, LUFTDUSCHE, HÖRSCHLAUCH
POWDER BLOWER, AIR DOUCHE, OTOSCOPE**

RU 7994-13
RU 7994-08
RU 7994-11



RU 7994-20

**Kabierske
RU 7994-01**

RU 7994-00 Pulverbläser, kpl. mit 3 Kanülen
(RU 7994-08 bis -13)
RU 7994-20 Ventilball
RU 7994-11 Kanüle für Nase
RU 7994-08 Kanüle für Rachen
RU 7994-13 Kanüle für Kehlkopf
RU 7994-01 Ersatz-Glasflasche
RU 7994-02 Deckel zu Pulverbläser

*Powder blower, complete
with 3 tips, RU 7994-08 – RU 7994-13*
Rubber bulb
Nasal tip
Aural tip
Larynx tip
Spare glass
Lid for powder blower

RU 7995-00 Politzer
Luftdusche, kpl. mit 3 Aufsätzen
*Air bag, complete
with 3 nasal tips*



Gummibirne
Rubber bulb
RU 7995-50



Verbindungsstück
Connector
RU 7995-03



Aufsätze
Nasal tips
RU 7995-15 15 mm Ø
RU 7995-17 17 mm Ø
RU 7995-22 22 mm Ø



**Jansen
RU 7996-00**

Hörschlauch, komplett mit einer schwarzen
Arztolive, 6 Patientenoliven (je 2 x # 1, 2, 3),
mit Ständer für Oliven

*Diagnostic tube complete with one physician
ear piece, black, 6 patient ear pieces (2 each
1, 2, 3) with rack for ear pieces.*

OHRSPRITZE, NIERENSCHALE
EAR SYRINGE, KIDNEY BOWL



RU 7997-01



RU 7997-02



RU 7997-04

Ohrspritze, komplett mit 2 Kanülen und 1 Schutzteller
Ear syringe, complete with 2 cannulas and 1 protection shield

50 ml **RU 7997-05**
75 ml **RU 7997-07**
100 ml **RU 7997-10**

Nierenschalen
Kidney bowls



0,25	170 x 36 mm	RU 8970-01
0,5	250 x 36 mm	RU 8970-02
0,75	275 x 45 mm	RU 8970-03

**OHRSPRITZE
EAR SYRINGE**



RU 7997-50
Ohrspritze, 10 ml, verchromt, komplett
Ear syringe, 10 ml, chromium-plated, complete

bestehend aus/consisting of:

- RU 7997-51**
- RU 7997-53**
- RU 7997-52**
- RU 7997-54**
- RU 7997-55**
- RU 7997-56**



RU 7997-51 Spritze, 10 ml, allein
Syringe, 10 ml, only



RU 7997-53 Plastikschlauch, 6 m
Plastic tube, 6 m

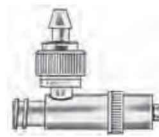

RU 7997-52 Ventilaufsatz, allein
Valve attachment, only



RU 7997-54 Saugfuß, allein
Metal sinker, only

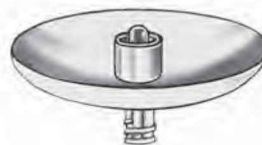

RU 7997-55 Schutzteller
Protection shield



RU 7997-56 Kanüle
cannula



RU 7997-57 Kanüle
cannula



RU 7997-58 Kanüle
cannula



RU 7997-59 Oliv-Aufsatz
cannula tip