

Augen-Instrumentarium
Eye Surgery
Oftalmologia
Chirurgie ophtalmologique
Oftalmologia

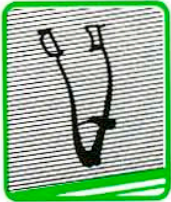

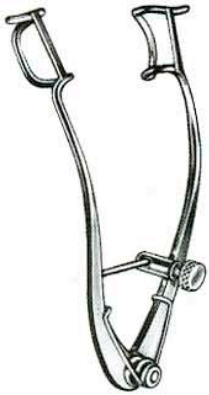

**Sperrelevatoren
Eye Specula
Blefarostatos
Blépharostats
Blefarostati**



Kinder
children
niños
enfants
bambini
7 cm/2³/₄"
RU 9000-07

Weiss

Erwachsene
adults
adultos
adultes
adulti
9 cm/3¹/₂"
RU 9000-09



Weiss

Kinder
children
niños
enfants
bambini
7 cm/2³/₄"
RU 9002-07

Erwachsene
adults
adultos
adultes
adulti
9 cm/3¹/₂"
RU 9002-09

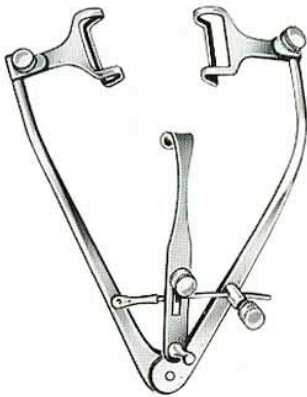

Park
8 cm/3¹/₄"
RU 9005-08

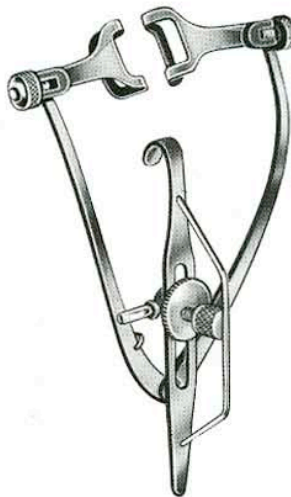

Park-Guyton
8 cm/3¹/₄"
RU 9006-08

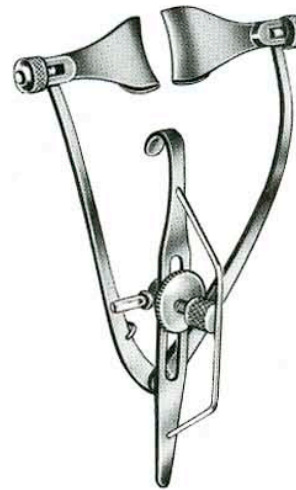

Park-Maumenee
8 cm/3¹/₄"
RU 9007-08

volle Valven
plain blades
hojas llenas
valves pleines
valve piene



Barraquer (Colibri)

Kinder
children
niños
enfants
bambini
3 cm/1¹/₄"
RU 9010-03

Erwachsene
adults
adultos
adultes
adulti
4 cm/1¹/₂"
RU 9010-04

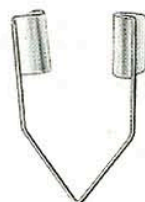

Barraquer
4 cm/1¹/₂"
RU 9011-04

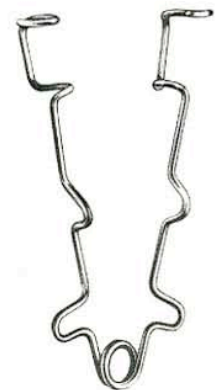

Bowman
7 cm/2³/₄"
RU 9012-07



Sperrelevatoren
 Eye Specula
 Blefarostatos
 Blépharostats
 Blefarostati

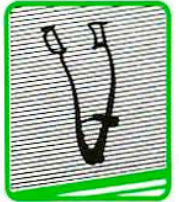

Sauer
 3 cm/1 1/4"
 RU 9014-03

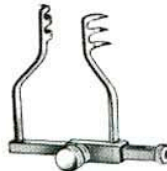

Goldstein
 3 cm/1 1/4"
 RU 9016-03

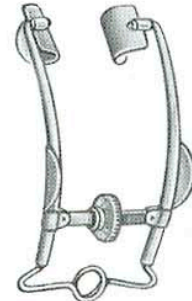

Pley
 6 cm/2 1/4"
 RU 9017-06

für das linke Auge
 for left eye
 para el ojo izquierdo
 pour l'oeil gauche
 per occhio sinistro

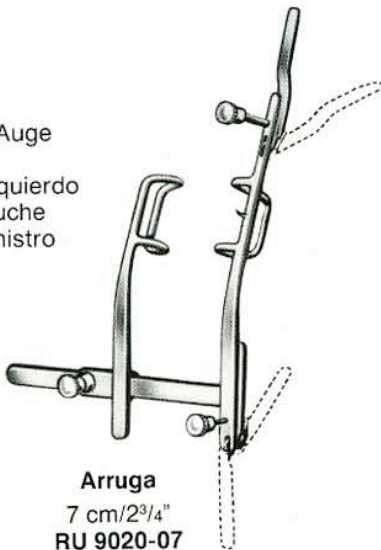

Arruga
 7 cm/2 3/4"
 RU 9020-07

für das rechte Auge
 for right eye
 para el ojo derecho
 pour l'oeil droit
 per occhio destro

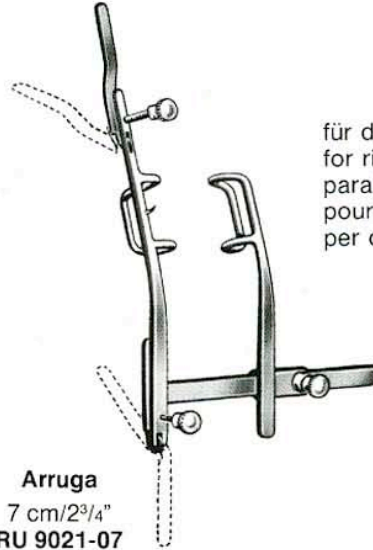

Arruga
 7 cm/2 3/4"
 RU 9021-07

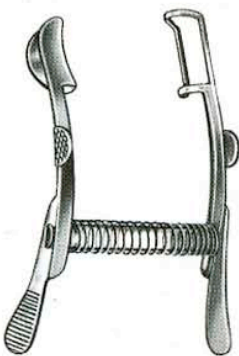

Mellinger-Axenfeld
 7 cm/2 3/4"
 RU 9024-07

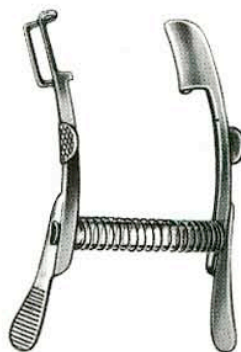

Mellinger-Axenfeld
 7 cm/2 3/4"
 RU 9025-07

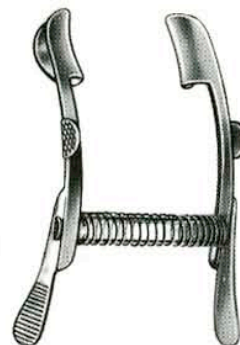

Mellinger

Kinder
 children
 niños
 enfants
 bambini
 5 cm/2"
 RU 9026-05

Erwachsene
 adults
 adultos
 adultes
 adulti
 7 cm/2 3/4"
 RU 9026-07



**Sperrelevatoren
Eye Specula
Blefarostatos
Blépharostats
Blefarostati**

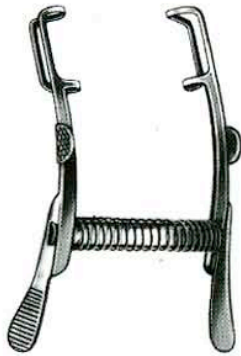

Mellinger Beard

Kinder
children
niños
enfants
bambini

5 cm/2"
RU 9028-05

Erwachsene
adults
adultos
adultes
adulti

7 cm/2³/₄"
RU 9028-07

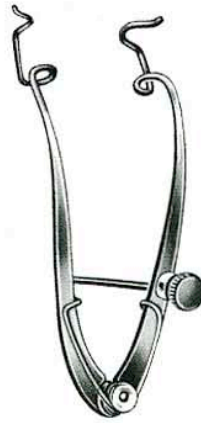

Knapp Clark

8 cm/3¹/₄"
RU 9030-08

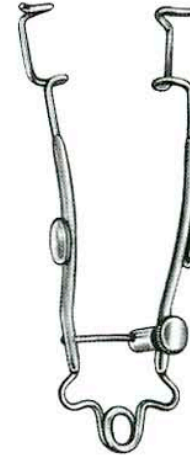

Graefe

Kinder
children
niños
enfants
bambini

6 cm/2¹/₂"
RU 9032-07

Erwachsene
adults
adultos
adultes
adulti

9 cm/3¹/₂"
RU 9032-09



Cook

Kinder
children
niños
enfants
bambini

4 cm/1¹/₂"
RU 9040-04

Erwachsene
adults
adultos
adultes
adulti

5 cm/2"
RU 9040-05

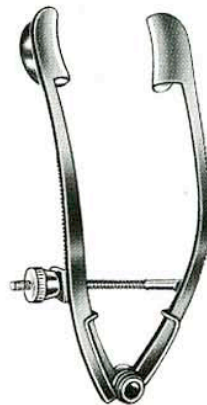

Lancaster
8 cm/3¹/₄"
RU 9042-08



Williams

Kinder
children
niños
enfants
bambini

7 cm/2³/₄"
RU 9044-07

Erwachsene
adults
adultos
adultes
adulti

8 cm/3¹/₄"
RU 9044-08



Sperrelevatoren
 Eye Specula
 Blefarostatos
 Blépharostats
 Blefarostati

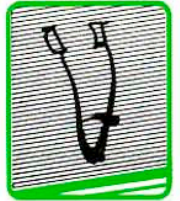

Lister-Burch
 8 cm/3 1/4"
 RU 9046-08

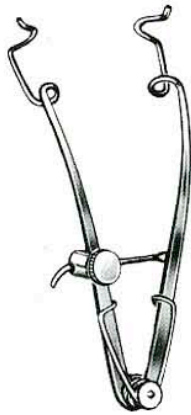

Weiss
 8 cm/3 1/4"
 RU 9050-08



Murdock
 5 cm/2"
 RU 9052-05

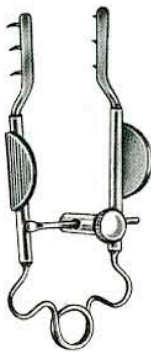

Mueller
 7 cm/2 3/4"
 RU 9054-07



Critchett
 6 cm/2 1/2"
 RU 9056-06



Castroviejo
 8 cm/3 1/4"
 RU 9058-01

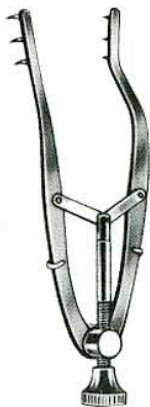

Stevenson
 7 cm/2 3/4"
 RU 9060-07

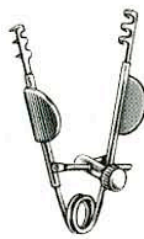

Agricola
 4 cm/1 1/2"
 RU 9062-04

für Erwachsene
 for adults
 para adultos
 pour adultes
 per adulti

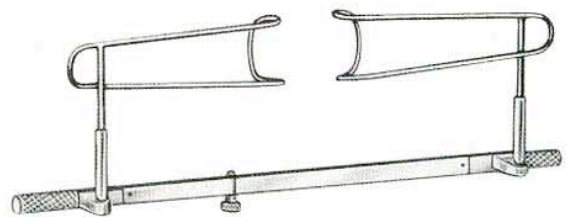

Schott
 14 cm/5 1/2"
 RU 9064-14



Tonometer
Tonometers
Tonómetros
Tonomètres
Tonometri

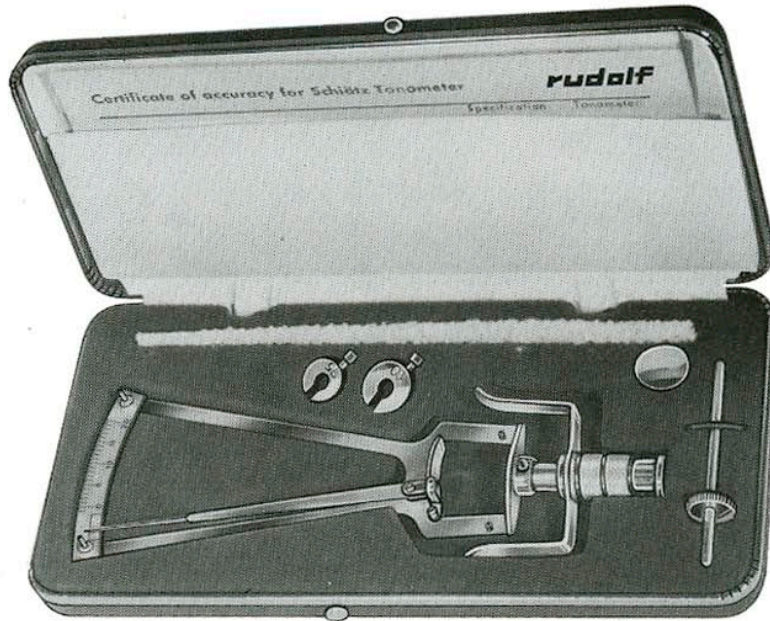

Schioetz

standard	golden golden coloured oro doré colore oro	grün green coloured verde vert colore verde		
RU 9080-00	RU 9080-10	RU 9080-20	gerade Skala échelle droite	straight scale escala recta scala retta
RU 9080-01	RU 9080-11	RU 9080-21	gebogene Skala échelle courbe	inclined scale escala inclinada scala curva

mit – with – avec – con Allen Retractor

RU 9082-00	RU 9082-10	RU 9082-20	gerade Skala échelle droite	straight scale escala recta scala retta
RU 9082-01	RU 9082-11	RU 9082-21	gebogene Skala échelle courbe	inclined scale escala inclinada scala curva

Specification No. 3

RU 9083-00	RU 9083-10	RU 9083-20	gebogene Skala échelle courbe	inclined scale escala inclinada scala curva
------------	------------	------------	----------------------------------	---



Lidinstrumente
Lid Instruments
Instrumental para párpados
Instruments pour les paupières
Strumenti per palpebre

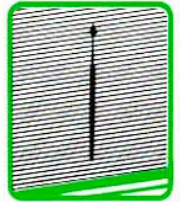

Schepens
13 cm/5"
RU 9100-13



Desmarres
13 cm/5"
RU 9104-13



8 mm

Conway
13 cm/5"
RU 9106-13



Desmarres
13 cm/5"



12 mm
RU 9120-12

14 mm
RU 9120-14

16 mm
RU 9120-16

18 mm
RU 9120-18

Lidplatte
Lid plate
Placa para párpados
Plaque à paupières
Placca per palpebre



Jaeger
11 cm/4 1/2"
RU 9128-11

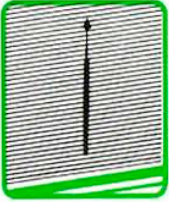

Augenskäpelle, Starmesser
Eye Scalpels, Cataract Knives
Bisturías para ojos, Cuchillos para cataratas
Bistouris pour les yeux, Couteaux à cataracte
Bisturi per occhi, Coltelli per cataratta



RU 9150-01



RU 9150-02



RU 9150-03



RU 9150-04



RU 9152-01



RU 9152-02



RU 9152-03



RU 9152-04



RU 9160-00



RU 9160-01



RU 9160-02



RU 9160-03



RU 9160-04



RU 9160-05

Graefe



RU 9162-01



RU 9162-02



RU 9162-03



RU 9162-04

Graefe-Arruga



Deutschmann
RU 9165-13



Wheeler
RU 9168-12

18 x 1 mm



Lanzenmesser (Keratome)
 Keratomes
 Querátomos
 Kératomes
 Cheratomi

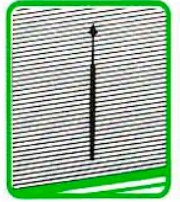

Jaeger
 RU 9180-01



RU 9180-02



RU 9180-03



RU 9180-04



RU 9181-01



RU 9181-02



RU 9181-03



RU 9181-04



RU 9182-01



RU 9182-02



RU 9182-03



RU 9182-04



RU 9184-01



RU 9184-02



RU 9184-03



RU 9184-04

Jaeger-Grieshaber



Biegung – curvature – curvatura – courbure – curvatura 45°
 RU 9185-01



RU 9185-02



RU 9185-03



RU 9185-04

Jaeger-Grieshaber



Lanzenmesser (Keratome), verschiedene Augenmesser
Keratomes, Various Eye Knives
Querátomos, Cuchillos diversas para ojos
Kératomes, Couteaux divers pour les yeux
Cheratomi, Coltelli diversi per occhi

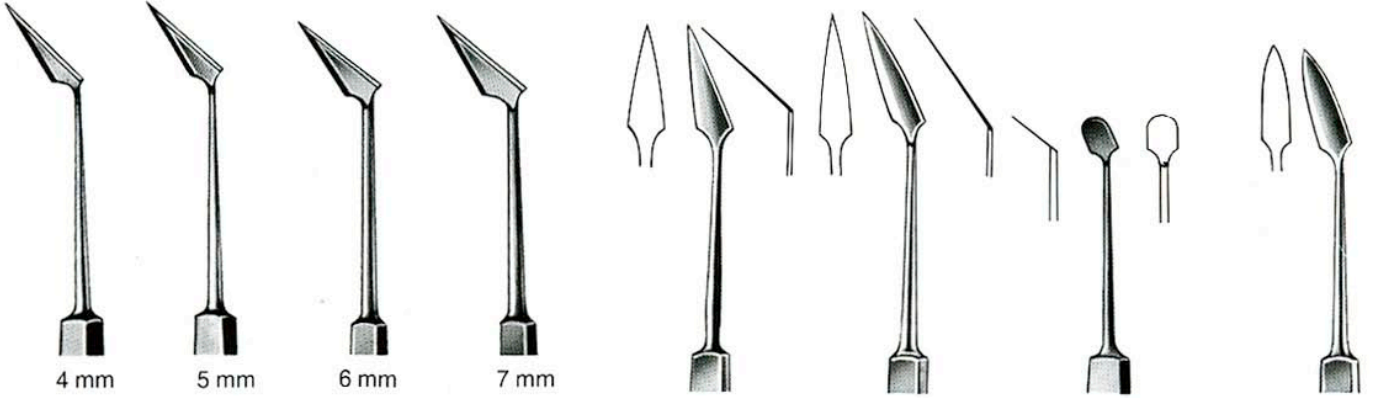

Wessely-Grieshaber
 Biegung – curvature – curvatura – courbure – curvatura 45°
 RU 9186-01 RU 9186-02 RU 9186-03 RU 9186-04

Wiener **RU 9190-13**

Berens **RU 9194-13**

Papst **RU 9196-13**

Castroviejo
 4 x 13 mm
RU 9198-13

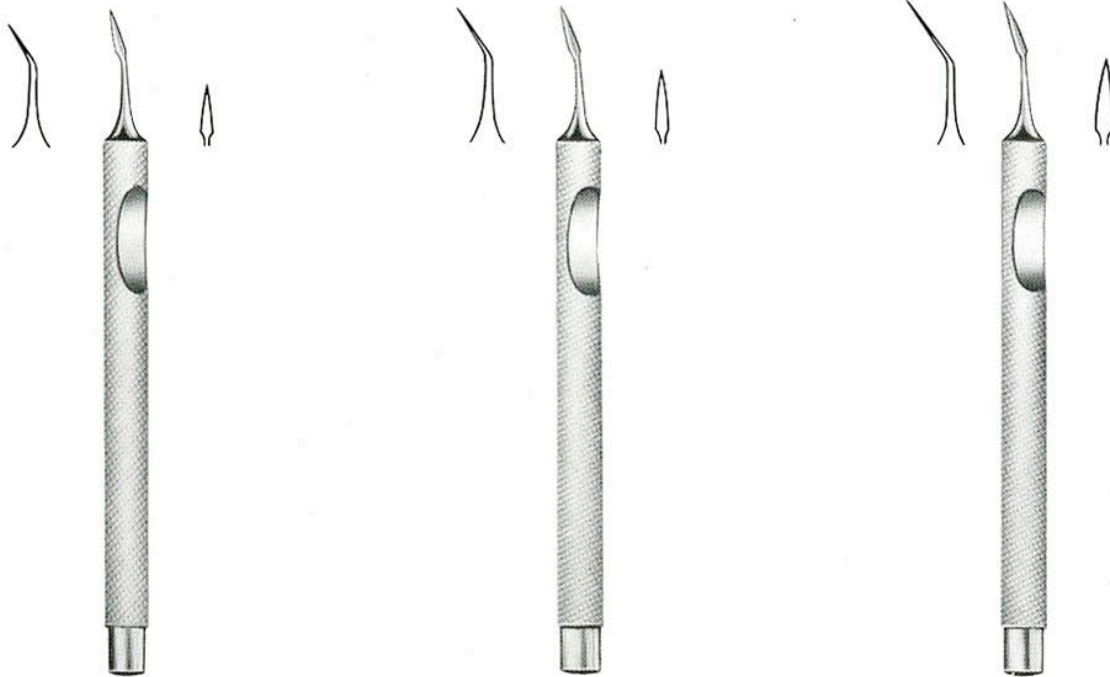

Castroviejo
 9 cm/3 1/2"
RU 9202-01

Castroviejo
 9 cm/3 1/2"
RU 9202-02

Castroviejo
 9 cm/3 1/2"
RU 9202-03



Verschiedene Augenmesser
Various Eye Knives
Cuchillos diversos para ojos
Couteaux divers pour les yeux
Coltelli diversi per occhi

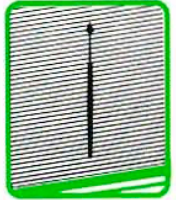

Mod. Hamburg
RU 9205-12



Graefe
RU 9208-13



Knapp
RU 9220-01 RU 9220-02 RU 9220-03

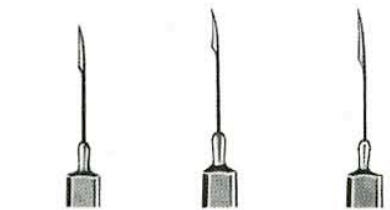

Ziegler
5 mm 6 mm 7 mm
RU 9225-05 RU 9225-06 RU 9225-07



Verschiedene Augenmesser
Various Eye Knives
Cuchillos diversos para ojos
Couteaux divers pour les yeux
Coltelli diversi per occhi



Dean
RU 9233-12



Ziegler
3 1/2 mm
RU 9230-11



Sato
RU 9232-12



Sichel
RU 9234-13



RU 9250-01



RU 9250-02



Kuhnt
RU 9250-03



RU 9250-04



Paton
RU 9252-12



Took
RU 9257-12



Gill
RU 9262-12



Verschiedene Augenmesser
Various Eye Knives
Cuchillos diversos para ojos
Couteaux divers pour les yeux
Coltelli diversi per occhi

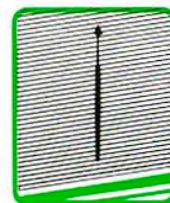

Anderson-
Critchett
RU 9281-12



Lundsgaard
RU 9282-12



Guyton-
Lundsgaard
RU 9284-12



Barken
RU 9292-12



Scheie
RU 9293-12



Burch
RU 9296-13



RU 9300-12



RU 9302-12



RU 9303-12



Bowman
RU 9314-12



Bowman
RU 9315-12



Schweiz. Mod.
RU 9319-12



RU 9320-13



RU 9321-13



Levinson
RU 9324-13



Alvis
RU 9325-12



Francis
RU 9327-12



Dizisionsnadeln, Fremdkörper-Instrumente
Discision Needles, Foreign Body Instruments
Agujas de discisión, Instrumental para cuerpos extraños
Aiguilles à discision, Instruments à corps étrangers
Aghi per discisione, Strumenti per corpi estranei



La Force
(Golf-Club)
RU 9328-12



Davis
RU 9330-13



Dix
RU 9332-13



Ellis
RU 9334-11



Plange
RU 9336-12



Nicati
RU 9338-12



Walton
RU 9339-12



Walton
RU 9350-12



Meyer
RU 9352-12



Green
RU 9354-13



Rollet
RU 9356-12



Standard
RU 9360-12

Fremdkörperschlinge und Magnet, in Umsteckhülse
 Foreign body remover and magnetic eye probe in reversible handle
 Asa e imán para cuerpos extraños, con mango reversible
 Anse et aimant pour corps étrangers, rentrant dans le manche réversible
 Ansa per corpi estranei con calamita, in manico reversibile



RU 9362-12

Fremdkörperschlinge und Magnet, in Umsteckhülse mit Lupe
 Foreign body remover and magnetic eye probe in reversible handle with magnifier
 Asa e imán para cuerpos extraños, con mango reversible y lente de aumento
 Anse et aimant pour corps étrangers, rentrant dans le manche réversible, avec loupe
 Ansa per corpi estranei con calamita, in manico reversibile con lente d'ingrandimento



Bulbusringe, Cystotome, Hakchen, Lokalisatoren
Bulb Rings, Cystotomes, Hooks, Locators
Anillos para bulbo, Cist6tomos, Ganchos, Localizadores
Anneaux pour cataracte, Kystitomes, Crochets, Localisateurs
Anelli per bulbo, Cistotomi, Uncini, Localizzatori

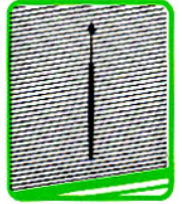

Flieringa

mm Ø

- RU 9366-14 = 14
- RU 9366-16 = 16
- RU 9366-18 = 18
- RU 9366-20 = 20
- RU 9366-22 = 22
- RU 9366-24 = 24



Graefe
RU 9370-13



Graefe
RU 9371-13



Graefe
RU 9372-13



Becker
biegsam
malleable
maleable
mall6able
malleabile
RU 9375-13



Mod. Bonn
14 cm/5 1/2"
RU 9379-14



Hirschmann
stumpf
blunt
romo
mousse
smusso
RU 9380-10



Graefe
scharf
sharp
agudo
pointu
acuto
RU 9382-12



Graefe
stumpf
blunt
romo
mousse
smusso
RU 9383-12



Knolle
RU 9384-13/01

◀ stumpf
blunt
romo
mousse
smusso



Jeffe-Knolle
RU 9384-13/02



O'Connor
RU 9386-12



Hirschmann
RU 9392-13



Graefe
RU 9393-13



Mc Gannan
13 cm/5"
RU 9395-13



Meyer-Schwickerath
13 cm/5"
RU 9398-13

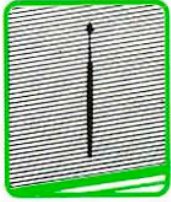

Fixierkrallen, Häkchen
Fixation Claws, Hooks
Garras fijadoras, Ganchitos
Ecarteurs de plaies, Crochets
Ganci per fissare, Uncini



Guthrie
RU 9400-12



Guthrie
RU 9400-13



Berens
RU 9402-12



Knapp
 stumpf
 blunt
 romo
 mousse
 smusso
RU 9405-13



Rollet
 spitz
 sharp
 agudo
 pointu
 acuto
RU 9406-12



Rollet
RU 9406-13



rechts – right
 a la derecha – à droite
 destro
RU 9409-01

links – left
 a la izquierda – à gauche
 sinistro
RU 9409-02

10,5 cm/4 1/4"



Häkchen, Wundlöffel
Hooks, Protectors
Ganchitos, Protectores para la separación de la retina
Crochets, Protège-sacs
Uncini, Protettori

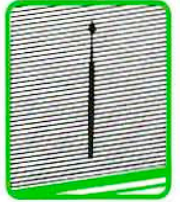

scharf
sharp
agudo
pointu
acuto
RU 9416-14

stumpf
blunt
romo
mousse
smusso
RU 9417-14

Axenfeld



scharf
sharp
agudo
pointu
acuto
RU 9418-14

stumpf
blunt
romo
mousse
smusso
RU 9419-14

Axenfeld



Paul
RU 9422-12



Sautter
RU 9423-01



Sautter
RU 9423-02



Sautter
RU 9423-03



Arruga
RU 9425-13



Stevens
RU 9428-14



Stevens
RU 9429-12



Graefe
RU 9430-01



Graefe
RU 9430-02



Graefe
RU 9430-03



Jaeger
RU 9432-01



Jaeger
RU 9432-02



Arruga
RU 9434-01
links – left
a la izquierda
à gauche
sinistro



Arruga
RU 9434-02
rechts – right
a la derecha
à droite
destro



Jameson
RU 9436-12



Green
RU 9438-13

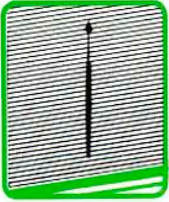

Linsenexpressoren, Zyklodialyse Spatel
Lens Expressors, Cyclodialysis Spatulas
Expresores para cristalino, Espátulas para ciclodiálisis
Expresseur pour les lentilles, Spatules pour la cyclodialyse
Espressori per cristallino, Spatole per ciclodialisi

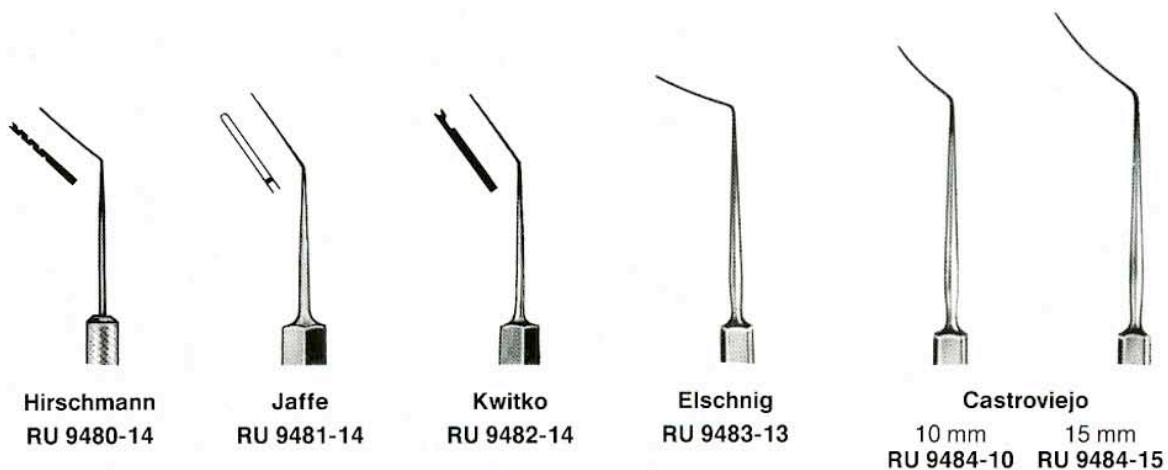
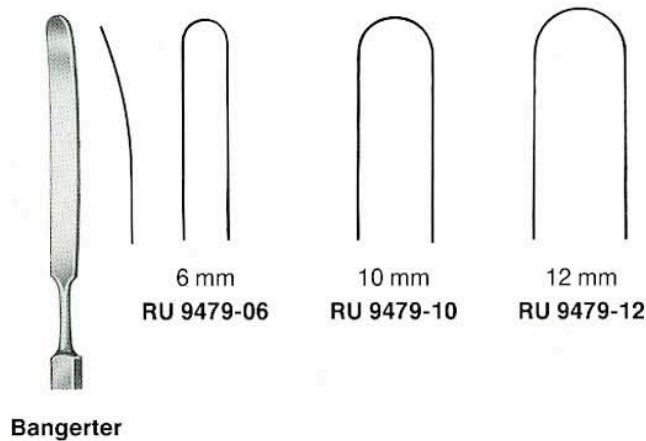
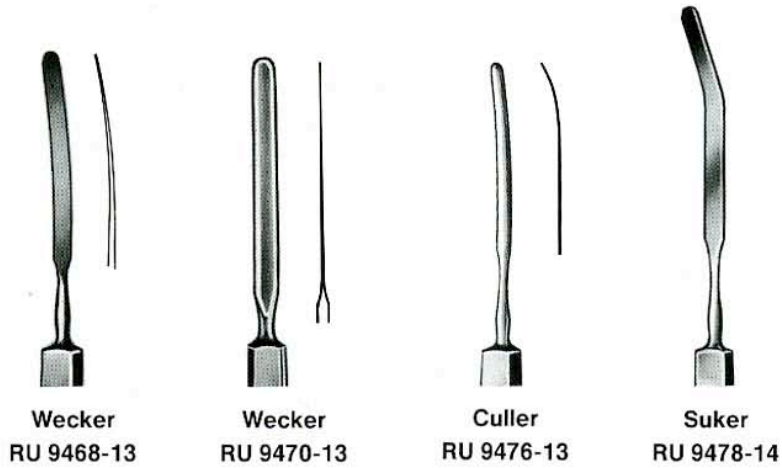



Spatel, Drahtschlingen, Linsenschieber, Starlöffel
Spatulas, Lens Scoops, Lens Expressors, Cataract Spoons
Espátulas, Asas, Expresores para cristalino, Cucharillas para catarata
Spatules, Anses et Expresseurs pour les lentilles, Curettes à cataracte
Spatole, Anse ed espressori per il cristallino, Cucchiaino per cataratta

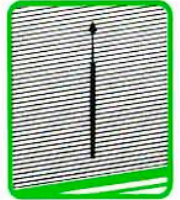

Spatelbreite
width of Spatula
anchura de espátula
largeur de la spatule
larghezze delle spatole

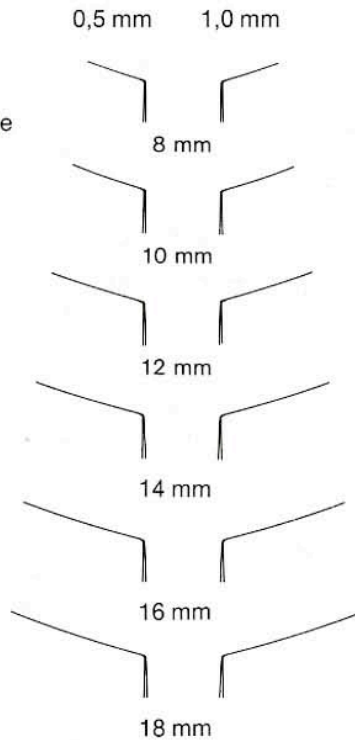

Castroviejo-Barraquer

RU 9490-08	8 mm	RU 9491-08
RU 9490-10	10 mm	RU 9491-10
RU 9490-12	12 mm	RU 9491-12
RU 9490-14	14 mm	RU 9491-14
RU 9490-16	16 mm	RU 9491-16
RU 9490-18	18 mm	RU 9491-18

gerieft serrated estriada strié zigrinata	glatt smooth lisa lisse liscia					
Castroviejo 9 cm/3 1/2" RU 9492-09	Castroviejo 9,5 cm/3 3/4" RU 9494-09	Lewis RU 9502-14	Lewis RU 9503-14	Weber RU 9505-13	Weber RU 9505-14	New Orleans RU 9506-13

glatt smooth lisa lisse liscia	gerieft serrated estriada strié zigrinata					
Snellen RU 9508-13	Arlt RU 9510-13 RU 9511-13	Hess RU 9512-13	Graefe RU 9515-01	Daviel RU 9516-01	Daviel RU 9516-02	Knapp RU 9522-12

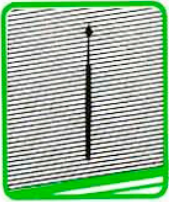

Enucleationslöffel, Chalazionslöffel
Enucleation Scoops, Chalazion Curettes
Cucharillas para enucleación, Cucharillas para chalazión
Cuillères pour énucléation, Curettes à chalazion
Cucchiai per enucleazione, Curette per calazio



Enucleationslöffel
 Enucleation scoops
 Cucharilla para enucleación
 Cuillères pour énucléation
 Cucchiai per enucleazione

klein
 small
 pequeña
 petit
 piccolo

Wells

RU 9528-16

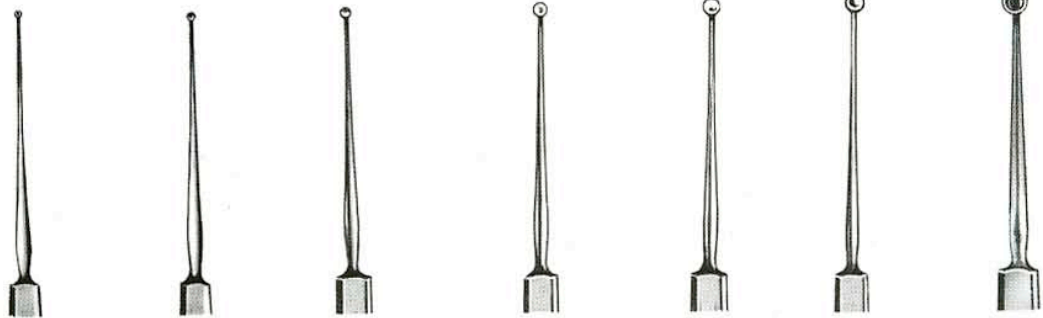

Meyhoefer

RU 9530-05 **RU 9530-10** **RU 9530-15** **RU 9530-18** **RU 9530-20** **RU 9530-25** **RU 9530-35**
 0,5 mm Ø 1,0 mm Ø 1,5 mm Ø 1,8 mm Ø 2,0 mm Ø 2,5 mm Ø 3,5 mm Ø



Meyhoefer **Meyhoefer** **Hebra**
RU 9530-40 **RU 9530-45** **RU 9532-10** **RU 9532-20** **RU 9532-25** **RU 9532-30** **RU 9532-35**
 4,0 mm Ø 4,5 mm Ø 1,0 mm Ø 2,0 mm Ø 2,5 mm Ø 3,0 mm Ø 3,5 mm Ø



Exenterationslöffel, Chalazion-Doppellöffel, Tränensack Dissektoren

Exenteration Scoops, Double Chalazion Curettes, Lachrymal Sac Dissectors

Cucharillas para exenteración, Cucharillas para chalación doble, Disectores para el saco lacrimal

Curettes pour exenération, Chalazion Curettes Doubles, Dissecteurs pour le sac lacrymal

Cucchiai per esenterazione, Cucchiaio doppio per calazio, Dissettore per il lacrimale

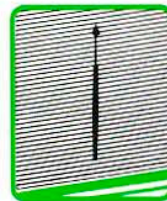

Exenterationslöffel
Exenteration scoops
Cucharillas para exenteración
Curettes pour exenération
Cucchiai per esenterazione



Bunge

RU 9550-01

RU 9550-02

RU 9550-03

RU 9550-04

RU 9550-05



Chalazion-Doppellöffel
Chalazion curette, double
Cucharilla para chalación, doble
Chalazion curette, double
Cucchiaio per calazio, doppio

Axenfeld
RU 9556-13



Tränensack-Dissektor
Lachrymal sac dissector
Disector para el saco lacrimal
Dissecteur pour le sac lacrymal
Dissettori per il sacco lacrimale

Lang
RU 9558-13



Augenkanülen
Eye Cannulas
Cánulas para ojos
Canules pour les yeux
Cannule per gli occhio



Spülkanülen
Irrigating Cannulas
Cánulas de irrigación
Canules d'irrigation
Cannule di irrigazione

Maßtabelle
 scale
 escala
 échelle
 scala di conversione

gauge = mm Ø

- 30 G = 0,30
- 29 G = 0,33
- 28 G = 0,35
- 27 G = 0,40
- 26 G = 0,45
- 25 G = 0,50
- 24 G = 0,55
- 23 G = 0,65
- 22 G = 0,70
- 21 G = 0,80
- 20 G = 0,90
- 19 G = 1,00
- 18 G = 1,20
- 17 G = 1,40
- 16 G = 1,60
- 15 G = 1,80
- 14 G = 2,10
- 13 G = 2,40
- 12 G = 2,80
- 11 G = 3,00

gerade
 straight
 recta
 droit
 retta



Binkhorst
 22 gauge
 RU 9560-00/01

rechts
 right
 a la derecha
 à droite
 destra



Binkhorst
 22 gauge
 RU 9560-00/02

links
 left
 a la izquierda
 à gauche
 sinistra



Binkhorst
 22 gauge
 RU 9560-00/03

geknöpft
 probe point
 abotonada
 boutonnée
 bottonuta

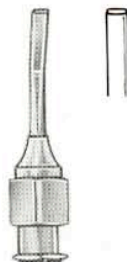

Bonn
 20 gauge
 RU 9560-00/04

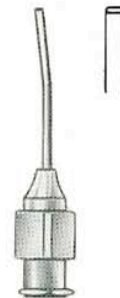

Bonn
 19 gauge
 RU 9560-00/05

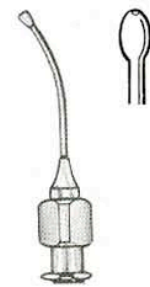

Hamburg
 23 gauge
 RU 9560-00/06



Augenkanülen
Eye Cannulas
Cánulas para ojos
Canules pour les yeux
Cannule per gli occhi



Spül- und Saugkanülen
Irrigation/Aspiration cannulas
Cánulas de irrigación y aspiración
Canules d'irrigation/d'aspiration
Cannule per irrigazione ed aspirazione

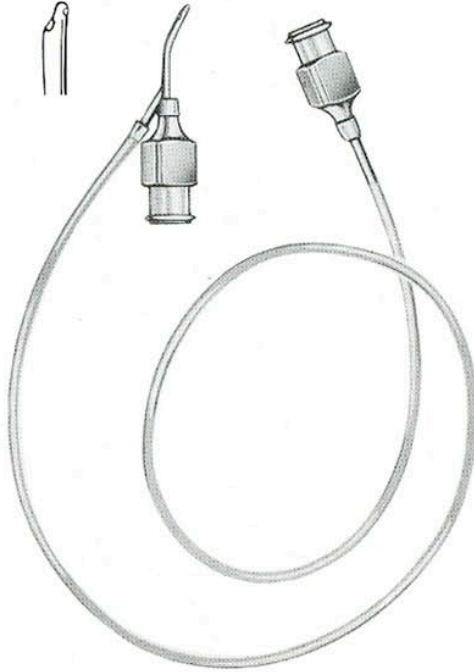

Simcoe
23 gauge
RU 9560-01/01

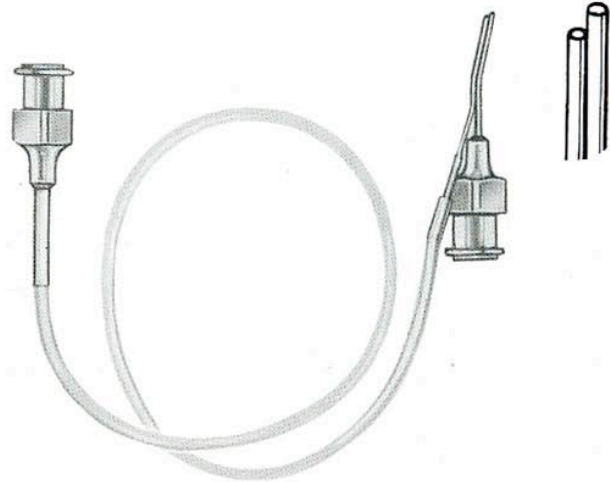

Gills-Welsh
25/23 gauge
RU 9560-01/02

Zystotomkanülen
Cystotome cannulas
Cánulas-Cistótomos
Canules à cystotome
Cannule per cistotomi



Knolle-Kelmann
22 gauge
RU 9560-02/01



Nevyas
22 gauge
RU 9560-02/02



Kratz
22 gauge
RU 9560-02/03

Linsenmanipulierkanüle
Lens manipulating cannula
Cánulas para manipulación de lentes
Canule pour la manipulation de lentilles
Cannule per manipolazione del cristallino

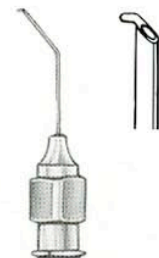

Freeman
27 gauge
RU 9560-03/00



Augenkanülen
Eye Cannulas
Cánulas para ojos
Canules pour les yeux
Cannule per gli occhi



Schlingenspülkanülen
 Irrigating vectis cannulas
 Cánulas-lazo con irrigación
 Canules d'irrigation à anse
 Cannule per irrigazione con sonda



Sheets
 RU 9560-04/01



Knolle Pearce
 RU 9560-04/02



Simcoe
 RU 9560-04/03

gerieft
 serrated
 estriada
 strié
 zigrinata

Kortexsaugkanülen
 Cortex aspirating cannulas
 Cánulas de aspiración para corteza
 Canules d'aspiration Cortex
 Cannule per l'aspirazione della corteccia

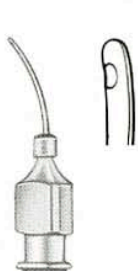

Simcoe
 23 gauge
 RU 9560-05/01

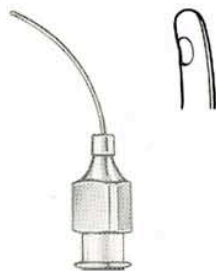

Simcoe
 23 gauge
 RU 9560-05/02

Kapselpolierkanülen
 Capsule polishing cannulas
 Cánulas para pulimentar las capsulas
 Canules pour polir les capsules
 Cannule per la pulizia delle capsule

posterior
 posteriore



Kratz
 RU 9560-06/01



Simcoe
 RU 9560-06/02



Jensen
 RU 9560-06/03



**Augenkanülen
Eye Cannulas
Cánulas para ojos
Canules pour les yeux
Cannule per gli occhi**



**Tränenwegkanülen
Lachrymal Cannulas
Cánulas para canal lacrimal
Canules pour le canal lacrymal
Cannule per le vie lacrimali**

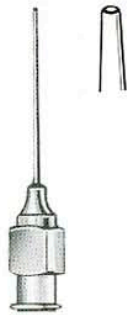

25 gauge
RU 9560-07/00



25 gauge
RU 9560-07/01



25 gauge
RU 9560-07/02

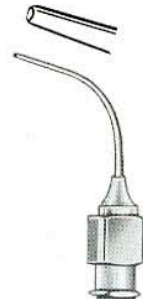

25 gauge
RU 9560-07/03

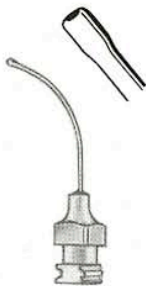

Bonn
19 gauge
RU 9560-07/05



Bangerter
RU 9560-07/04 40 mm
RU 9560-07/06 60 mm



Anel
23 gauge
RU 9560-07/07



Anel
23 gauge
RU 9560-07/08



Augenkanülen
Eye Cannulas
Cánulas para ojos
Canules pour les yeux
Cannule diversi per gli occhi



Enzymkanüle
 Alpha-chymotrypsin cannula
 Cánula de enzima
 Canule d'enzyme
 Cannula d'enzima



23 gauge
 RU 9560-08/00

Luftinjektionskanüle
 Air injection cannula
 Cánula para inyección de aire
 Canule à injection d'air
 Cannula per iniezione d'aria



Sauter
 27 gauge
 RU 9560-09/00

Kragenknopfkanüle
 Collar button cannulas
 Cánulas forma botón en cuello
 Canule boutonnée
 Cannula bottonuta



Graether

gerade
 straight
 droite
 recta
 retta
 RU 9560-10/01

abgewinkelt
 angled
 acodada
 coudé
 angolata
 RU 9560-10/02

Messerkanüle
 Knife cannula
 Cánula-bisturí
 Canule à couteaux
 Cannula a coltello



Sato
 23 gauge
 RU 9560-11/00

V/K-Punktionskanüle
 A/C puncture cannula
 Cánula de punción
 Canule à ponction
 Cannula a punzione

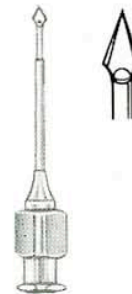

Schreck
 21 gauge
 RU 9560-12/01



Augenkanülen
Eye Cannulas
Cánulas para ojos
Canules pour les yeux
Cannule per gli occhi



V/K-Punktionskanüle
A/C puncture cannula
Cánula de punción
Canule à ponction
Cannula a punzione

Kataraktnadel
Cataract needle
Agujas para cataratas
Aiguille à cataracte
Cannula per cataratta

Absaugkanüle
Aspirating cannula
Cánulas de aspiración
Canule d'aspiration
Cannula d'aspirazione



Amsler
21 gauge
RU 9560-12/02

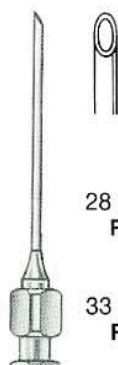

19 gauge
28 mm × 1,0 mm Ø
RU 9560-13/01

17 gauge
33 mm × 1,5 mm Ø
RU 9560-13/02

Scheie

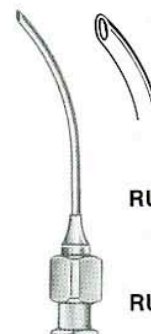

19 gauge
1,1 mm
RU 9560-14/01

17 gauge
1,5 mm
RU 9560-14/02

Ullerich

Retrobulbäre Nadeln
Retrobulbar needles
Cánulas retrobulbares
Aiguilles rétrobulbaires
Cannula retrobulbari

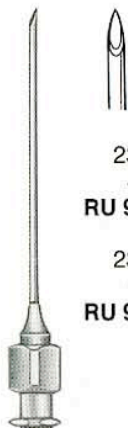

23 gauge
40 mm
RU 9560-15/01

23 gauge
60 mm
RU 9560-15/02

Bangerter
25 gauge



Handstück
Handle
Mango
Poignée
Manico

RU 9560-16/00



Hornhautbohrer, Hornhauttrephinen, Markierungsinstrumente
Corneal Burrs, Corneal Trephines, Calipers and Markers
Fresas y trépanos corneales, Marcadores
Perforateurs et Trépan cornéens, Compas et Marqueurs
Perforatore, Trapani corneali, Strumenti per compassi e marcatori



mm Ø	Grieshaber
1,0	RU 9580-10
1,5	RU 9580-15
2,0	RU 9580-20
2,5	RU 9580-25



RU 9585-50



1,5 mm Ø
RU 9585-15



2,0 mm Ø
RU 9585-20

Elliot
 komplett · complete
 completo · complet · completo
 ——— RU 9585-00 ———

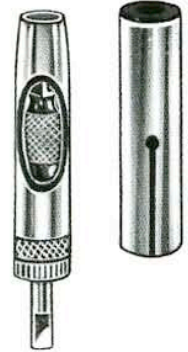

mm Ø	Castroviejo
5,0	RU 9588-50
5,5	RU 9588-55
6,0	RU 9588-60
6,5	RU 9588-65
7,0	RU 9588-70
8,0	RU 9588-80
9,0	RU 9588-90
10,0	RU 9588-98



mm Ø Arruga



Arruga

6	RU 9600-06	RU 9602-06
7	RU 9600-07	RU 9602-07
8	RU 9600-08	RU 9602-08
9	RU 9600-09	RU 9602-09
10	RU 9600-10	RU 9602-10



Arruga
RU 9605-00



Castroviejo
RU 9610-15
 Meßbereich: 15 mm
 Measuring range:
 15 mm
 Alcance de
 medición: 15 mm
 Echelle: 15 mms
 Raggio di misura-
 zione: mm 15

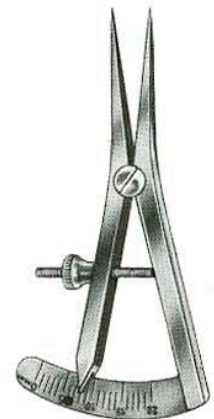

Castroviejo
RU 9610-20
 Meßbereich: 20 mm
 Measuring range:
 20 mm
 Alcance de
 medición: 20 mm
 Echelle: 20 mms
 Raggio di misura-
 zione: mm 20



Markierungsinstrumente, Stanzen, Meißel, Tränenkanal-Dilatatoren
Marking Instruments, Punches, Chisels, Lachrymal Dilators
Instrumental para marcar, Punzonadoras capsulares, Cinceles, Disectores lacrimales
Instruments à marquage, Emporte-pièces, Rugines, Dilatateurs pour le canal lacrymal
Strumenti per marcare, punzoni, scalpello e scorbie, dilatatori per il canale lacrimale

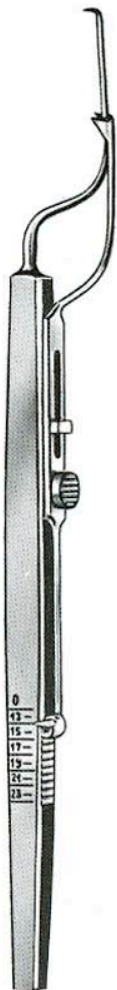

Connin-Amsler
RU 9614-13



Holth
RU 9620-00



West
RU 9626-16



West
RU 9627-16



Wilder
RU 9630-01



Wilder
RU 9630-02



Wilder
RU 9630-03



Tränenkanal-Dilatatoren, -Sonden
 Lachrymal Dilators and Probes
 Dilatadores y estiletos para canal lacrimal
 Dilatateurs et sondes pour le canal lacrymal
 Dilatatori e sonde per il canale lacrimale



Castroviejo
 RU 9632-12



Simpson
 RU 9638-01



Harms
 RU 9640-01



Harms
 RU 9640-02

Bowman
 Fig.

0000/000	RU 9651-00/3
000/00	RU 9651-00/2
00/0	RU 9651-00
0/1	RU 9651-01
1/2	RU 9651-12
2/3	RU 9651-23
3/4	RU 9651-34
4/5	RU 9651-45
5/6	RU 9651-56
6/7	RU 9651-67
7/8	RU 9651-78



Bowman
 Fig.

0000/000	RU 9652-00/3
000/00	RU 9652-00/2
00/0	RU 9652-00
0/1	RU 9652-01
1/2	RU 9652-12
2/3	RU 9652-23
3/4	RU 9652-34
4/5	RU 9652-45
5/6	RU 9652-56
6/7	RU 9652-67
7/8	RU 9652-78



lieferbare Materialart: NS Neusilber oder SI Silber
 material: NS German silver or SI silver
 materia: NS plata nueva o SI plata
 matière: NS d'argent alliage ou SI argent
 materiale disponibile: NS lega d'argento o SI argento



Doppelinstrumente
Double-Ended Instruments
Instrumental doble
Instruments doubles
Strumenti doppi



Castroviejo

Castroviejo

Spatelbreite
width of spatula
anchura de espátula
largeur de spatule
larghezza delle spatole
mm

0,5	RU 9670-05
0,75	RU 9670-07
1,00	RU 9670-10



Castroviejo
RU 9672-12



Wheeler
RU 9678-12



Smith-Fisher
RU 9682-12



Green
RU 9684-12



Dix
RU 9690-01



Dix
RU 9690-02



Stille
RU 9691-02



RU 9692-12



Doppelinstrumente
Double-Ended Instruments
Instrumental doble
Instruments doubles
Strumenti per corpi estranei



RU 9693-13



RU 9694-13

Nadel, allein
Needle, only
Aguja, suelta
Aiguille, seule
Ago, solo
RU 9695-01

Flachmeißel, allein
Chisel, only
Cinzel, suelto
Ciseau-burin, seul
Scalpello, solo
RU 9695-02

Hohlmeißel, allein
Gouge, only
Gubia, suelta
Gouge, seule
Sgorbia, solo
RU 9695-03



RU 9696-13



Instrumente für Radiale Keratotomie
Instruments for Radial Keratotomy
Instrumental para queratoma radial
Instrument pour la k eratotomie radiale
Strumenti per cheratotomia radiale

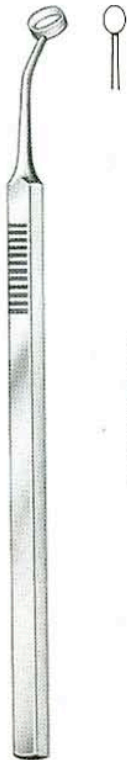

- RU 9773-01 = 3,0 x 3,5 mm
- RU 9773-02 = 3,0 x 4,0 mm
- RU 9773-03 = 3,0 x 4,5 mm
- RU 9773-04 = 3,5 x 4,0 mm
- RU 9773-05 = 3,5 x 4,5 mm
- RU 9773-06 = 3,5 x 5,0 mm

Bores

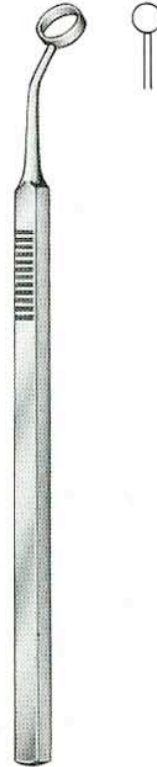

- RU 9773-51 = 2,75 mm
- RU 9773-52 = 3,0 mm
- RU 9773-53 = 3,25 mm
- RU 9773-54 = 3,75 mm
- RU 9773-55 = 4,0 mm
- RU 9773-56 = 4,25 mm
- RU 9773-57 = 4,5 mm
- RU 9773-58 = 4,75 mm
- RU 9773-59 = 5,0 mm
- RU 9773-60 = 6,0 mm
- RU 9773-61 = 8,0 mm

Bores

Markierungsinstrumente
 Marking instruments
 Instrumental para marcar
 Instruments   marquer
 Strumenti per marcare



- RU 9775-01 = 3,0 mm
- RU 9775-02 = 3,25 mm
- RU 9775-03 = 3,5 mm
- RU 9775-04 = 3,75 mm
- RU 9775-05 = 4,0 mm
- RU 9775-06 = 4,25 mm
- RU 9775-07 = 4,5 mm
- RU 9775-08 = 4,75 mm
- RU 9775-09 = 5,0 mm
- RU 9775-10 = 5,5 mm
- RU 9775-11 = 6,0 mm
- RU 9775-12 = 7,0 mm
- RU 9775-13 = 8,0 mm
- RU 9775-14 = 9,0 mm
- RU 9775-15 = 11,0mm

Hoffer



- 3 - 5 mm
- RU 9776-00

Hoffer



- 3 - 5 - 7 mm
- RU 9777-01



- 3 - 6 - 8 mm
- RU 9777-02

Hoffer



Instrumente für Radiale Keratotomie
Instruments for Radial Keratotomy
Instrumental para queratomia radial
Instruments pour la kératotomie radiale
Strumenti per cheratotomia radiale



Hornhautmarkierungsinstrumente
Corneal markers
Marcadores corneales
Marqueurs cornéens
Marcatori corneali

Fixationsringe
Fixation rings
Anillos fijadoras
Anneaux de fixation
Anelli di fissaggio

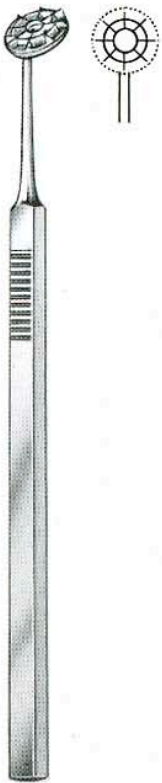

Arrowsmith
10 cm/4"
RU 9778-10

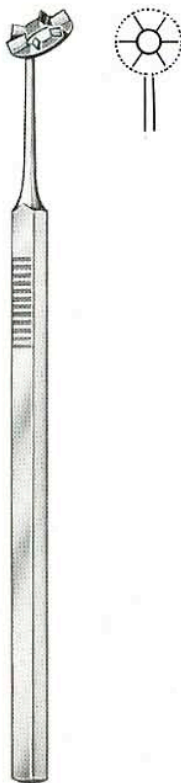

Bores
10 cm/4"
RU 9779-10

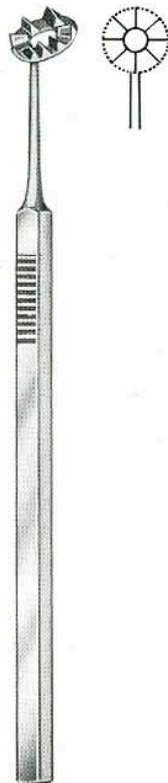

Bores
10 cm/4"
RU 9780-10



Bores
10 cm/4"
RU 9781-10

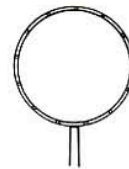

Thornton
10 cm/4"
RU 9782-10





Fadenpinzetten
Suture Forceps
Pinzas para sutura
Pinces à sutures (à filament)
Pinze per sutura

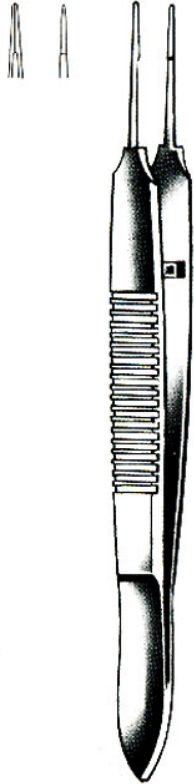
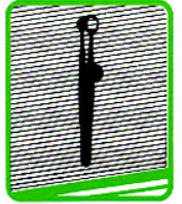

Mod. Tübingen
10 cm/4"
RU 9800-10



8,5 cm/3 1/2"
RU 9802-08

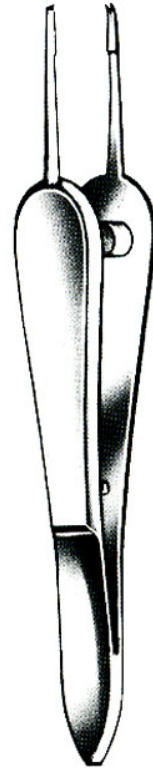

Paufique
10 cm/4"
RU 9804-10

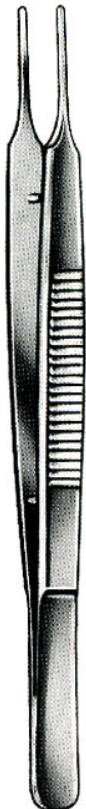

Barraquer modif.
10,5 cm/4 1/4"
RU 9806-10

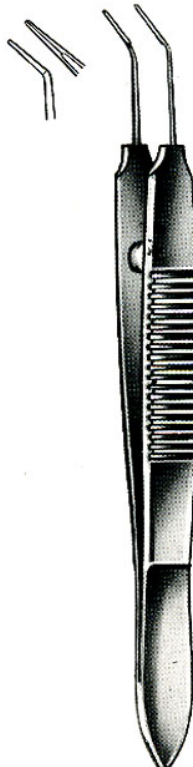

Mc Pherson
10 cm/4"
RU 9807-10



Mc Pherson
7,5 cm/3"
RU 9808-07



Nahtpinzetten, Strabismuspinzetten
Suture Forceps, Strabismus Forceps
Pinzas para sutura, Pinzas para estrabismo
Pinces à sutures, Pinces à strabisme
Pinze per sutura, Pinze per strabismo



Mc Cullough
 9,5 cm/3¾"
 RU 9810-09



Mc Cullough
 9,5 cm/3¾"
 RU 9811-09



Bonaccolto
 10 cm/4"
 RU 9814-10



Bonaccolto
 10 cm/4"
 RU 9815-10



11 cm/4½"
 RU 9818-11



11 cm/4½"

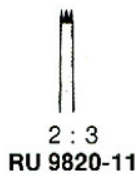
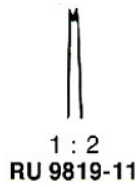

Nugent
 10 cm/4"



RU 9821-01



RU 9821-02



Strabismus-, Muskel- und Vorlagerungspinzetten
Strabismus, Muscle and Advancement Forceps
Pinzas para estrabismo, Pinzas para avanzamiento muscular
Pinces à strabisme, à muscles et à antéposition
Pinze per strabismo, Pinze per avanzamento muscolare

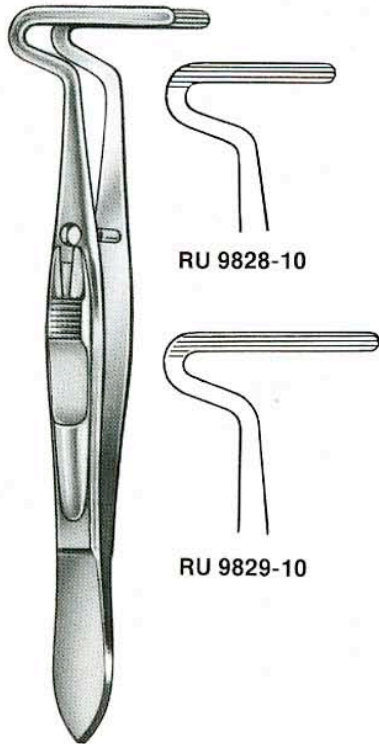

RU 9828-10

RU 9829-10

Berke
10 cm/4"



Blascovics
9 cm/3 1/2"
RU 9830-09

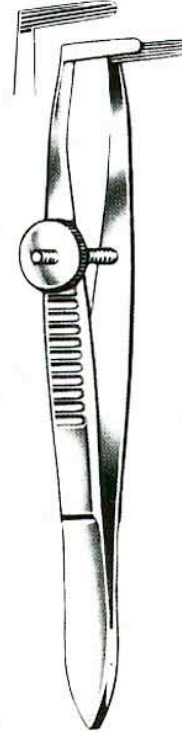

Blascovics
9 cm/3 1/2"
RU 9831-09

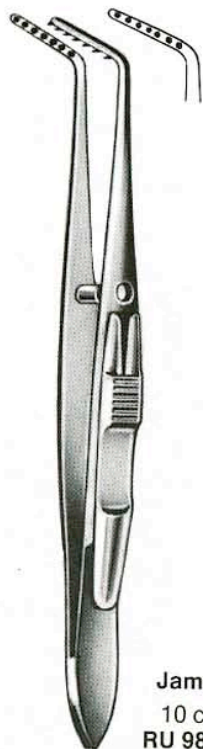

Jameson
10 cm/4"
RU 9834-10

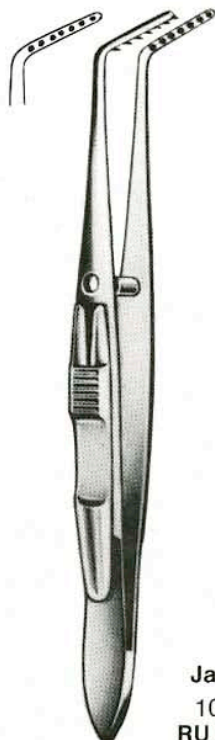

Jameson
10 cm/4"
RU 9835-10



Prince
10 cm/4"
RU 9836-10

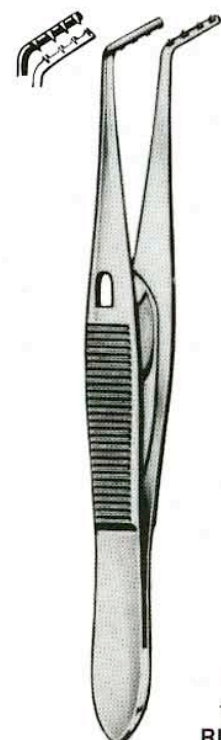

Prince
10 cm/4"
RU 9837-10



Muskelpinzetten, Vorlagerungs- und Entropiumpinzetten
Muscular Forceps, Advancement and Entropium Forceps
Pinzas musculares, Pinzas para avanzamiento y entropión
Pincès à muscles, Pincès à antéposition et à entropion
Pinze muscolari, Pinze per avanzamento ed entropia

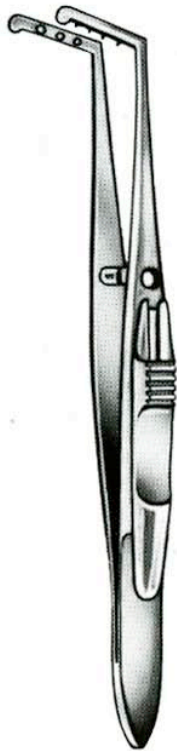

Sattler
10 cm/4"
RU 9838-10

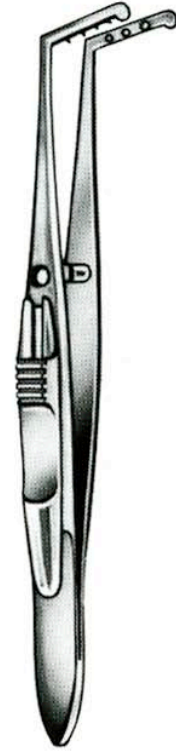

Sattler
10 cm/4"
RU 9839-10



Snellen
10 cm/4"
RU 9840-10

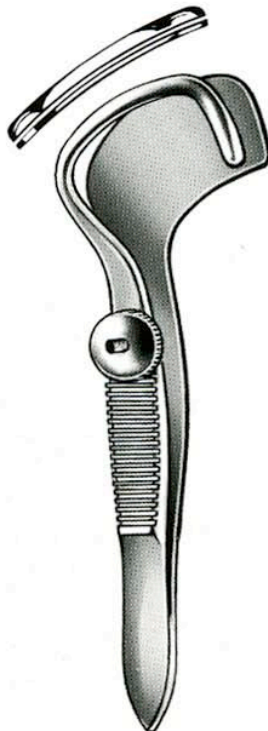

Snellen
10 cm/4"
RU 9841-10

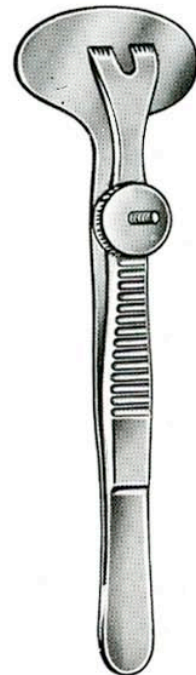

Erhardt
9 cm/3 1/2"
RU 9845-09



Vorderkammerpinzetten, Irispinzetten
Anterior Chamber Forceps, Iris Forceps
Pinzas para camera anterior, Pinzas para iris
Pinces à chambre antérieure, Pinces pour l'iris
Pinze per camera anteriore, Pinze per l'iride

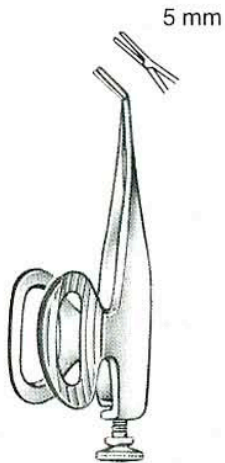

Barraquer
5,5 cm/2 1/4"
RU 9846-05

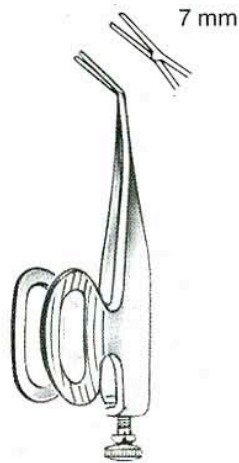

Barraquer
5,5 cm/2 1/4"
RU 9846-07

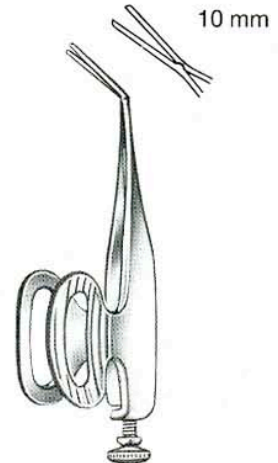

Barraquer
5,5 cm/2 1/4"
RU 9846-10



Hess
9 cm/3 1/2"
RU 9850-09

◀ Schweizer Modelle
Swiss patterns
modelos suizos
modèles suisses
modelli svizzeri ▶



Hess
9 cm/3 1/2"
RU 9851-09



Irispinzetten
Iris Forceps
Pinzas para iris
Pinces pour l'iris
Pinze per l'iride

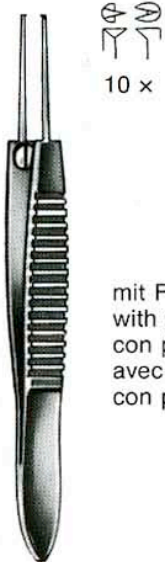

10 x

mit Führungsstift
 with guide pin
 con perno guida
 avec repères
 con perno di guida

1 : 2
Mod. Bonn
 7 cm/2³/₄"
 RU 9853-07



10 x

ohne Führungsstift
 without guide pin
 sin perno guida
 sans repères
 senza perno di guida

1 : 2
Mod. Bonn
 7 cm/2³/₄"
 RU 9854-07



0,12 mm

Mod. Bonn
 10 cm/4"
 RU 9855-10



Bishop-Harman
 8,5 cm/3¹/₂"
 RU 9856-08



Bishop-Harman
 8,5 cm/3¹/₂"
 RU 9857-08



Bishop-Harman
 8,5 cm/3¹/₂"
 RU 9858-08

fein
 fine
 finas
 fin
 fine

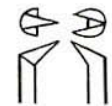
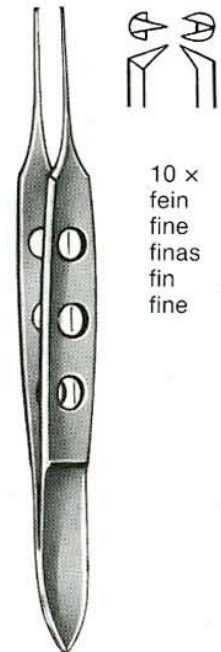

10 x
 fein
 fine
 finas
 fin
 fine

1 : 2
Bishop-Harman
 8,5 cm/3¹/₂"
 RU 9859-08



Irispinzetten, Englisches Modell
Iris Forceps, British Pattern
Pinzas para iris, modelo inglés
Pinces pour l'iris, modèle anglais
Pinze per l'iride, modello inglese

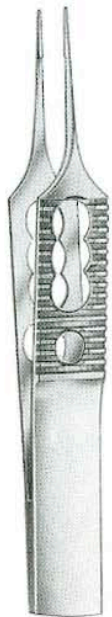

gerade
straight
rectas
droite
retta

8 cm/3¹/₄"

mit Fadenplatte, ohne Zähne
with foot plate, without teeth
con mini-placas, sin dientes
avec plateaux pour fils, sans dents
con piatto per fili, senza denti

gerade – straight – rectas – droite – retta
RU 9860-01

abgewinkelt – angled – acodadas – coudée – angolata
RU 9860-02

gebogen – curved – curvas – courbe – curva
RU 9860-03



abgewinkelt
angled
acodadas
coudée
angolata

8 cm/3¹/₄"

mit Fadenplatte, mit Zähnen 0,25 mm
with foot plate, with teeth 0,25 mm
con mini-placas, con dientes 0,25 mm
avec plateaux pour fils, avec dents 0,25 mm
con piatto per fili, con denti 0,25 mm

gerade – straight – rectas – droite – retta
RU 9861-01

abgewinkelt – angled – acodadas – coudée – angolata
RU 9861-02

gebogen – curved – curvas – courbe – curva
RU 9861-03

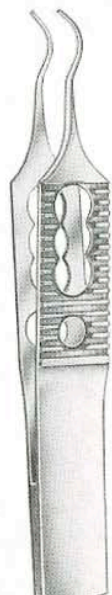

gebogen
curved
curva
courbe
curva

8 cm/3¹/₄"

ohne Fadenplatte, mit Zähnen 0,25 mm
without foot plate, with teeth 0,25 mm
sin mini-placas, con dientes 0,25 mm
sans plateaux pour fils, avec dents 0,25 mm
senza piatto per fili, con denti 0,25 mm

gerade – straight – rectas – droite – retta
RU 9862-01

abgewinkelt – angled – acodadas – coudée – angolata
RU 9862-02

gebogen – curved – curvas – courbe – curva
RU 9862-03



Irispinzetten
Iris Forceps
Pinzas para iris
Pinces pour l'iris
Pinze per l'iride



Graefe

7 cm/2³/₄"

0,5 mm **RU 9870-05**
 0,7 mm **RU 9870-07**
 1,0 mm **RU 9870-10**



Graefe

7 cm/2³/₄"

0,5 mm **RU 9871-05**
 0,7 mm **RU 9871-07**
 1,0 mm **RU 9871-10**



**1 : 2
Graefe**

7 cm/2³/₄"

0,5 mm **RU 9872-05**
 0,7 mm **RU 9872-07**
 1,0 mm **RU 9872-10**



**1 : 2
Graefe**

7 cm/2³/₄"

0,5 mm **RU 9873-05**
 0,7 mm **RU 9873-07**
 1,0 mm **RU 9873-10**

ohne Zähne
 without teeth
 sin dientes
 sans dents
 senza denti



Foerster

8,5 cm/3¹/₂"
RU 9876-08



Foerster

8,5 cm/3¹/₂"
RU 9877-08

mit
 with
 con
 avec
 con

1 : 2 Zähnen
 1 : 2 teeth
 1 : 2 dientes
 1 : 2 dents
 1 : 2 denti



Foerster

8,5 cm/3¹/₂"
RU 9878-08

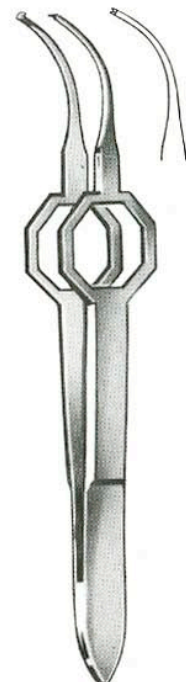

Foerster

8,5 cm/3¹/₂"
RU 9879-08



Irispinzetten, Bindehautpinzetten
Iris Forceps, Conjunctival Forceps
Pinzas para iris, Pinzas para conjuntiva
Pinces pour l'iris, Pinces pour la conjonctive
Pinze per l'iride, Pinze per congiuntiva



Graefe
10 cm/4"



RU 9880-10



RU 9881-10



RU 9882-10



RU 9883-10



RU 9884-10



RU 9885-10

Bindehautpinzetten
 Conjunctival forceps
 Pinzas para conjuntiva
 Pinces pour la conjonctive
 Pinze per congiuntiva



Stevens
10,5 cm/4 1/4"



RU 9890-10



RU 9891-10



RU 9892-10



RU 9893-10



RU 9894-10



RU 9895-10

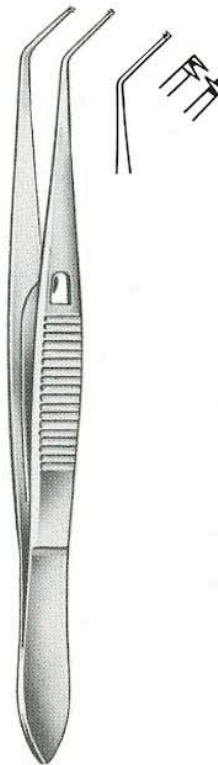

O'Connor
10 cm/4"
RU 9896-10



Irispinzetten, Fixierpinzetten, Kapselpinzetten
Iris Forceps, Fixation Forceps, Capsular Forceps
Pinzas para iris, Pinzas de fijación, Pinzas capsulares
Pinces pour l'iris, à fixation et capsulaires
Pinze per l'iride, Pinze di fissazione, Pinze capsulari

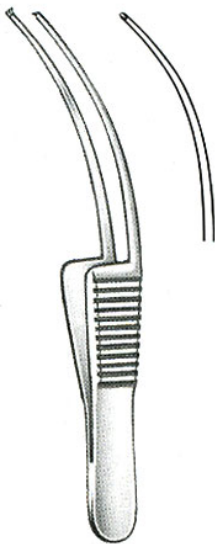

Fischer
 7 cm/2³/₄"
 RU 9900-07

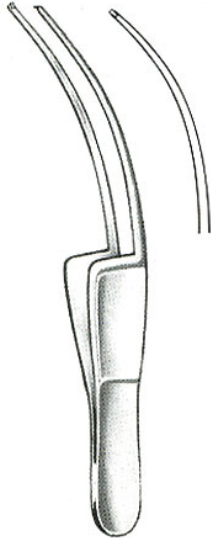

Fischer-Arlt
 7 cm/2³/₄"
 RU 9901-07



Hess
 7 cm/2³/₄"
 RU 9902-07



Hess
 7 cm/2³/₄"
 RU 9904-07

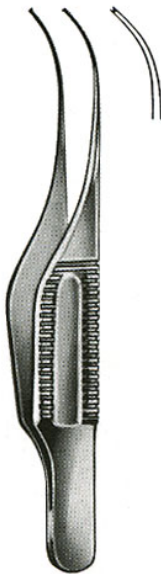

Gill
 7,5 cm/3"
 RU 9908-07



Gill-Hess
 7,5 cm/3"
RU 9909-07 Zähne seitwärts
 teeth on side
 dientes laterales
 dents latérales
 denti laterali
RU 9910-07 Zähne unten
 teeth below
 dientes inferiores
 dents en bas
 denti in basso

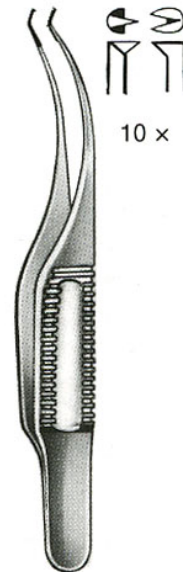

**Barraquer-Katzin
 (Colibri)**
 7 cm/2³/₄"
 RU 9911-07



Irispinzetten, Fixierpinzetten, Kapselpinzetten
Iris Forceps, Fixation Forceps, Capsular Forceps
Pinzas para iris, Pinzas de fijación, Pinzas capsulares
Pinces pour l'iris, à fixation et capsulaires
Pinze per l'iride, Pinze di fissazione, Pinze capsulari

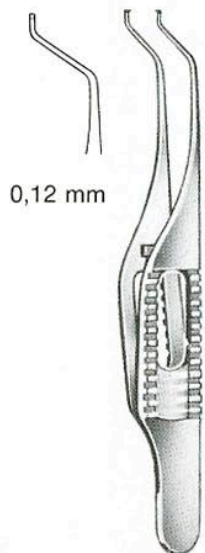

0,12 mm

Troutman (Colibri)
 7,5 cm/3"
 RU 9913-07/01

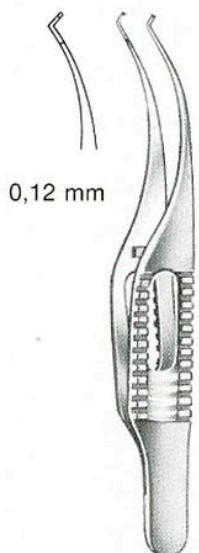

0,12 mm

Barraquer (Colibri)
 7 cm/2³/₄"
 RU 9913-07/02

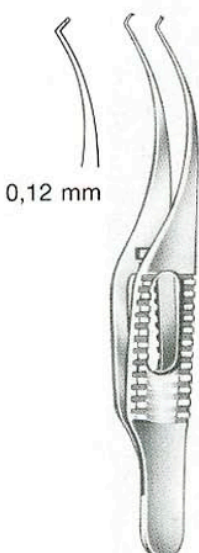

0,12 mm

Barraquer-Katzin (Colibri)
 7 cm/2³/₄"
 RU 9913-07/03

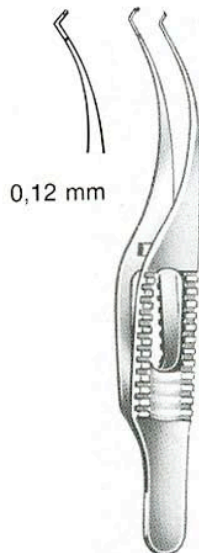

0,12 mm

Barraquer (Colibri)
 7 cm/2³/₄"
 RU 9913-07/04

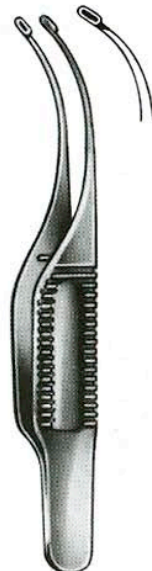

Gill-Arruga
 7,5 cm/3"
 RU 9914-07



Terson
 9 cm/3¹/₂"
 RU 9915-09



Schweigger
 10 cm/4"
 RU 9916-10

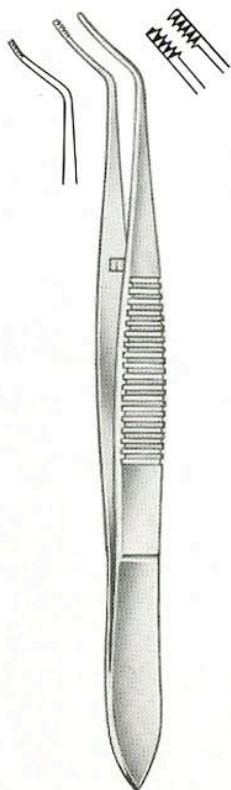

Schweigger
 10 cm/4"
 RU 9916-10/01

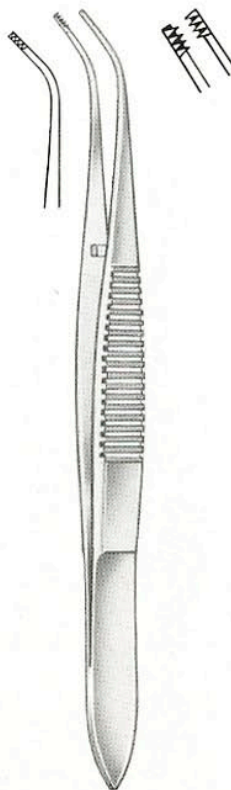

Elschnig
 10 cm/4"
 RU 9917-10



Hess
 6 cm/2¹/₄"
 RU 9918-06



Hess
 6,5 cm/2¹/₂"
 RU 9919-06



Kapselpinzetten
Capsular Forceps
Pinzas capsulares
Pinces capsulaires
Pinze capsulari

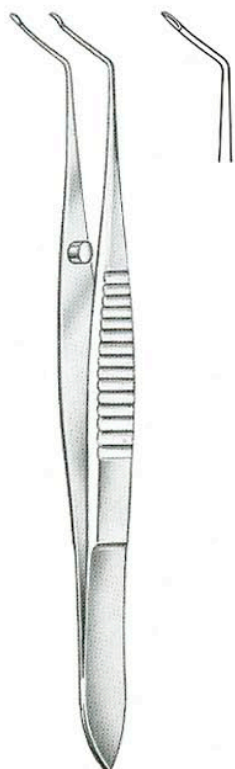

Kalt
 10 cm/4"
 RU 9921-10



Arruga-Nizetic
 10 cm/4"
 RU 9923-10



Castroviejo
 10 cm/4"
 RU 9925-10



Elschnig
 10 cm/4"
 RU 9926-10

für Linsenimplantation
 for lens implantation
 para implantación de lentes
 pour l'implantation du cristallin
 per l'impiantazione del cristallino



Binkhorst
 7 cm/2³/₄"
 RU 9927-07



Arruga
 9,5 cm/3³/₄"
 RU 9928-09



Arruga
 9,5 cm/3³/₄"
 RU 9929-09



**Kapselpinzetten, Kapselsauger
Capsular Forceps, Erisiphakes
Pinzas capsulares, Erisifacos
Pincas capsulaires, Aspirateurs capsulaires
Pinze capsulari, Aspiratore per capsule**

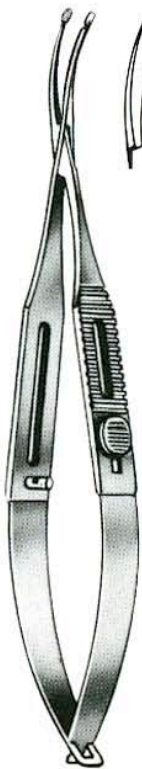

mit Irrigator
with irrigator
con irrigador
avec irrigateur
con irrigatore
RU 9930-01

ohne Irrigator
without irrigator
sin irrigador
sans irrigateur
senza irrigatore
RU 9931-01

Shepard



Silicon allein
silicone alone
silicona suelta
silicone seule
silicone solo
RU 9931-10

Dastoor
6 cm/2 1/4"
RU 9931-06



geeicht
calibrated
calibrada
calibrée
calibrata

Arruga
10 cm/4"
RU 9932-10

Arruga
10 cm/4"
RU 9933-10



geeicht
calibrated
calibrada
calibrée
calibrata

Arruga
10 cm/4"
RU 9934-10

Arruga-Elschnig
10 cm/4"
RU 9935-10



Trachompinzetten, Chalazionpinzetten
 Trachoma Forceps, Chalazion Forceps
 Pinzas para tracoma, Pinzas para chalación
 Pincés pour le trachome, Pincés à chalazion
 Pinze per tracoma, Pinze per calazio



Ayer
 9 cm/3 1/2"
 RU 9938-09

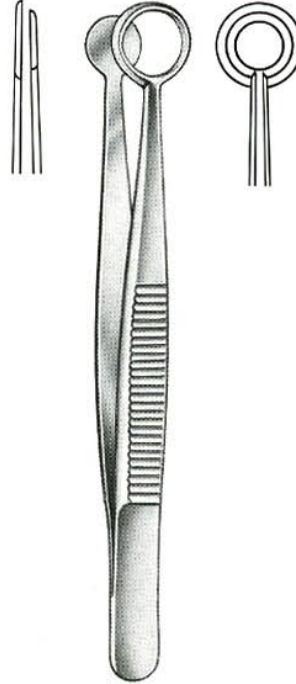

Ayer
 9 cm/3 1/2"
 RU 9938-09/01



Lambert
 9 cm/3 1/2"
 RU 9939-09



Desmarres
 9 cm/3 1/2"



RU 9940-01



RU 9940-02



RU 9940-03



Instrumente für Radiale Keratotomie
Instruments for Radial Keratotomy
Instrumental para queratoma radial
Instrumenti per la kératotomie radiale
Strumenti per cheratotomia radiale



Hornhautfixierpinzetten
Corneal fixation forceps
Pinzas para fijación corneal
Pincas à fixation cornéenne
Pinze per fissazione corneale

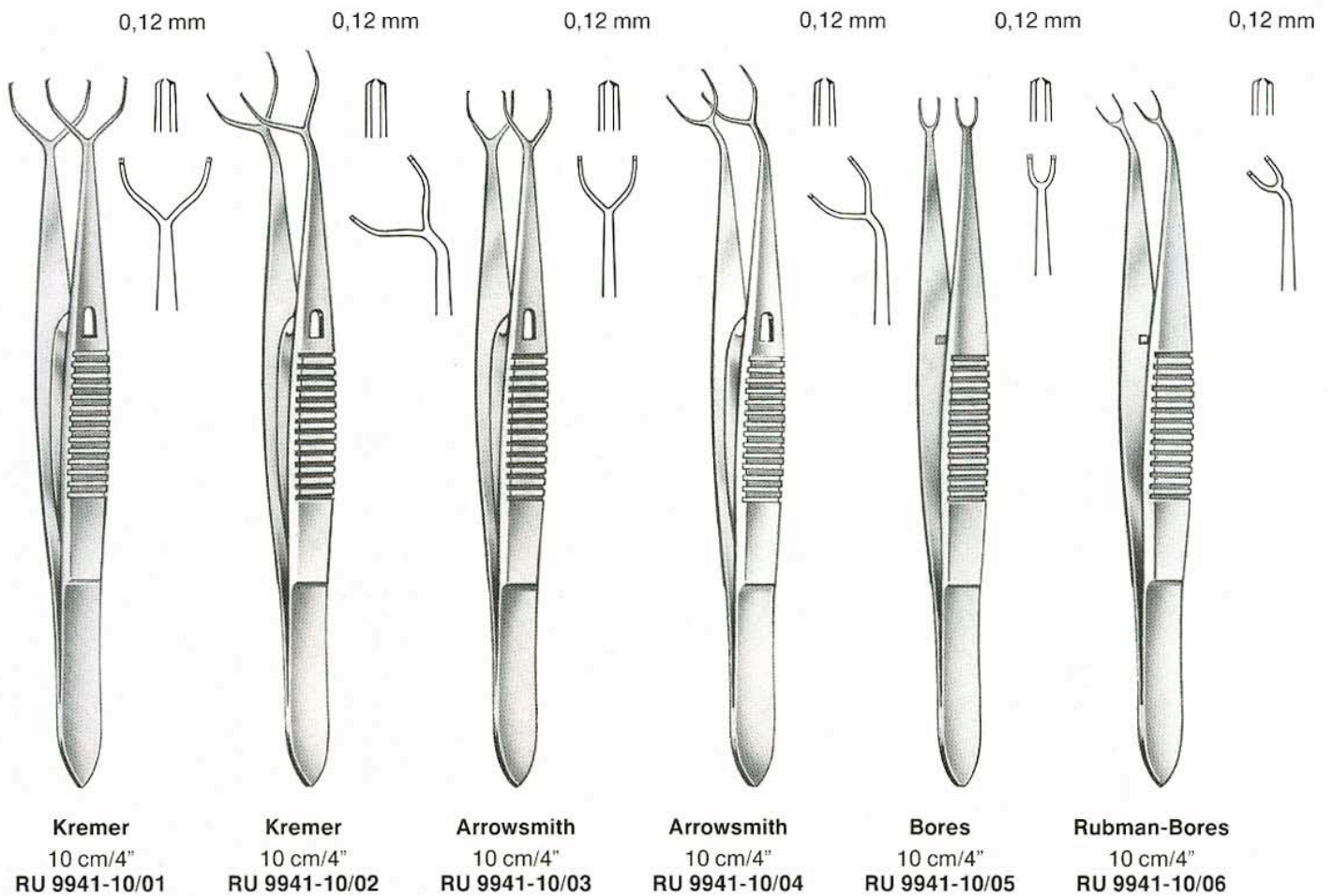



Fixierpinzetten, Faßpinzetten
Fixation Forceps, Tissue Forceps
Pinzas de fijación, Pinzas con dientes
Pinces à fixation, Pinces à griffes
Pinze di fissazione, Pinze da presa



ohne Schloß
 without spring catch
 sin cierre de resorte
 sans arrêt à ressort
 senza cremagliera
RU 9942-11

mit Schloß
 with spring catch
 con cierre de resorte
 avec arrêt à ressort
 con cremagliera
RU 9943-11

Graefe
 11 cm/4 1/2"



2 : 3 Zähne
 2 : 3 teeth
 2 : 3 dientes
 2 : 3 dents
 2 : 3 denti

11 cm/4 1/2"
RU 9945-11



3 : 4 Zähne
 3 : 4 teeth
 3 : 4 dientes
 3 : 4 dents
 3 : 4 denti

11 cm/4 1/2"
RU 9946-11



Castroviejo
 9 cm/3 1/2"
RU 9948-09



Castroviejo
 9 cm/3 1/2"
RU 9950-09



Faßpinzetten, Nahtpinzetten
 Tissue Forceps, Suture Forceps
 Pinzas con dientes, Pinzas para sutura
 Pincès à griffes, Pincès à sutures
 Pinze chirurgiche, Pinze per sutura



Moorfield
 10 cm/4"
 RU 9955-10



Lester
 9 cm/3 1/2"
 RU 9958-12 1 : 2
 RU 9958-23 2 : 3

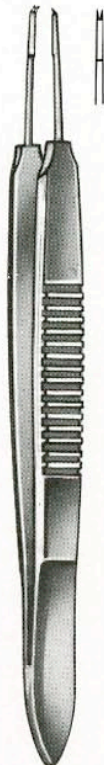

Castroviejo
 10 cm/4"

gerade straight rectas droites rette	Zahnbreite width of teeth ancho de dientes largeur de dents larghezza dei denti	gebogen curved curvas courbes curve
RU 9964-01	0,12 mm	RU 9965-01
RU 9964-03	0,3 mm	RU 9965-03
RU 9964-05	0,5 mm	RU 9965-05
RU 9964-10	1,0 mm	RU 9965-10
RU 9964-15	1,5 mm	RU 9965-15



Castroviejo
 10 cm/4"



Fixierpinzetten, Faßpinzetten, Uhrmacherpinzetten
Fixation Forceps, Tissue Forceps, Watchmaker Forceps
Pinzas de fijación, Pinzas con dientes, Pinzas de relojero
Pinces à fixation, à griffes, Pinces d'horloger
Pinze di fissazione, Pinze da presa, Pinze d'orologiaio



St. Martin
 7 cm/2¾"
 RU 9968-07



Elschnig
 11 cm/4½"
 RU 9974-11



Elschnig
 11 cm/4½"
 RU 9975-11



Barraquer
 10 cm/4"
 RU 9978-10



Green
 10 cm/4"

breit	ohne Schloß
wide	without spring catch
ancha	sin cierre de resorte
largeur	sans arrêt à ressort
larghezza	senza cremagliera

5 mm	RU 9980-05
10 mm	RU 9980-10

breit	mit Schloß
wide	with spring catch
ancha	con cierre de resorte
largeur	avec arrêt à ressort
larghezza	con cremagliera

5 mm	RU 9981-05
10 mm	RU 9981-10



11,5 cm/4½"
 RU 4240-07



11,5 cm/4½"
 RU 4240-03



Unterbindungsadeln
Ligature Needles
Agujas para ligaduras
Aiguilles à ligatures
Aghi per legature



Woodruff
13 cm/5"
RU 9990-13



Woodruff
13 cm/5"
RU 9991-13



Jacobi
14 cm/5 1/2"
RU 9993-14