

# LARYNGOLOGIE ENDOLARYNGEALE MIKROCHIRURGIE

## LARYNGOLOGY ENDOLARYNGEAL MICROSURGERY

Seiten 383 - 412

*Pages 383 - 412*

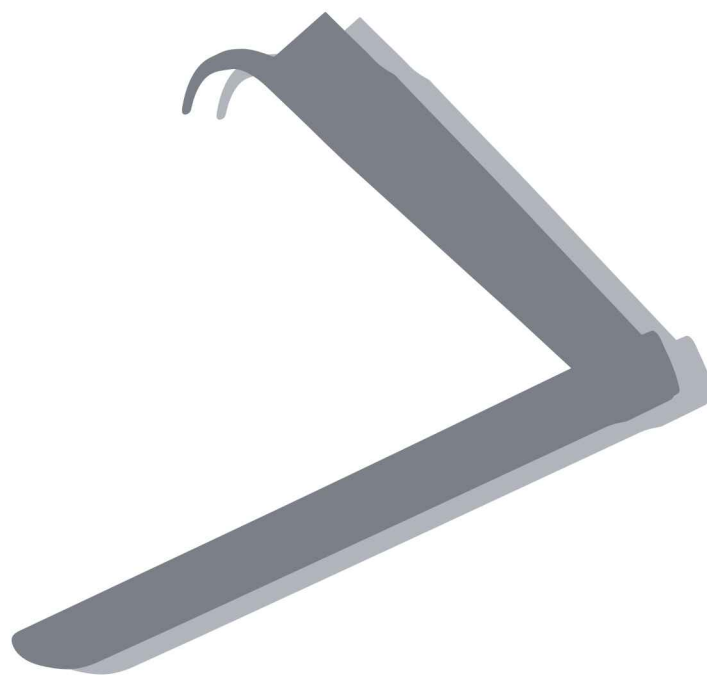

### Übersicht

Laryngoskopgriffe, Zubehör  
Laryngoskope  
Kaltlicht-Laryngoskope  
Operationslaryngoskope, Bruststütze  
Lichtträger, Kanülen, Saugrohre  
Zangen, Zangenaufsätze  
Laryngoskopie-Instrumente  
Watteträger, Kanülen  
Spritzen, Zerstäuber, Spiegel  
Griffe, Verlängerungsrohre  
Kehldeckelhalter, Scheren

### Overview

*Handles for laryngoscopes, accessories*  
*Laryngoscopes*  
*Fiber Optic laryngoscopes*  
*Operation laryngoscopes, chest support*  
*Light guide, drain-, suction tubes*  
*Forceps, forceps tips*  
*Laryngeal instruments*  
*Laryngeal applicators, -needles*  
*Syringes, atomizer, mirrors*  
*Handles, tubes*  
*Epiglottis retractors, scissors*

### Seiten / Pages

384  
385-388  
389-391  
392-395  
394  
396-401, 407, 408, 410, 411  
402-404  
405-406  
406, 409  
407  
410-411

**GRIFFE FÜR LARYNGOSKOPE  
HANDLES FOR LARYNGOSCOPES**

ohne Batterien/*without batteries*



Ø 30 mm  
**RU 5180-10**

mit Trafoanschluß  
*with transformer connection*  
**RU 5180-10/01**



Ø 30 mm  
**RU 5180-11**



Ø 18 mm  
**RU 5185-10**

Batteriegriffe, für konventionelle Batterien/*Battery handles, for conventional batteries*



für Spatel Fig. 0 – 1  
*for blades Fig. 0 to 1*

**RU 5180-08**

Ersatzlämpchen/*Spare bulb*



für Spatel Fig. 2 – 5  
*for blades Fig. 2 to 5*

**RU 5180-09**



**RU 5180-12**

NC-Akku 1,8 V  
aufladbar über Transformator  
*NC-Accumulator 1,8 V,  
rechargeable from transformer*



220 V **RU 5180-13**  
110 V **RU 5180-14**  
Transformator  
*Transformer*

Trafo 220 Volt mit 1,4 m langem Kabel.  
Trafo 110 Volt mit amerikanischem Netzanschluß.  
Bei eventuellem Fehlen oder Ausfallen von Batterien und Akkus direkter Netzanschluß über Trafo möglich.  
*Transformer 220 Volt with cable 1.40 m long.  
Transformer 110 Volt with american mains adapter.  
If batteries and accus are not available or out of order, direct mains adapter use via transformer is*

**LARYNGOSKOPE  
LARYNGOSCOPES**



**Laryngoskopie-Spatel nach McIntosh  
McIntosh Laryngoscope Blades**

Fig.	Nutzlänge working length	Gesamtlänge length	
0	<b>53 mm</b>	<b>75 mm</b>	<b>RU 5180-00</b>
1	<b>68 mm</b>	<b>90 mm</b>	<b>RU 5180-01</b>
2	<b>88 mm</b>	<b>110 mm</b>	<b>RU 5180-02</b>
3	<b>108 mm</b>	<b>130 mm</b>	<b>RU 5180-03</b>
4	<b>128 mm</b>	<b>150 mm</b>	<b>RU 5180-04</b>
5	<b>148 mm</b>	<b>170 mm</b>	<b>RU 5180-05</b>



**McIntosh**

**RU 5180-30** Satz in Etui, mit 3 Spateln, bestehend aus:

*Set in case, with 3 blades, consisting of:*

**RU 5180-10**  
**RU 5180-01**  
**RU 5180-02**  
**RU 5180-03**  
**RU 5180-99** Etui/case

**RU 5180-40** Satz in Etui, mit 4 Spateln, bestehend aus:

*Set in case, with 4 blades, consisting of:*

**RU 5180-10**  
**RU 5180-01**  
**RU 5180-02**  
**RU 5180-03**  
**RU 5180-04**  
**RU 5180-99** Etui/case

**Baby-Mc-Intosh**

**RU 5180-42** Satz in Etui, mit 3 Spateln, bestehend aus:

*Set in case, with 3 blades, consisting of:*

**RU 5180-10**  
**RU 5180-00**  
**RU 5180-01**  
**RU 5180-02**  
**RU 5180-99** Etui/case

**LARYNGOSKOPE  
LARYNGOSCOPES**



**Laryngoskopie-Spatel nach Wisconsin-Foregger  
Wisconsin-Foregger Laryngoscope Blades**

Fig.	Nutzlänge working length	Gesamtlänge length	
0	<b>70 mm</b>	<b>92 mm</b>	<b>RU 5182-00</b>
1	<b>93 mm</b>	<b>115 mm</b>	<b>RU 5182-01</b>
2	<b>108 mm</b>	<b>130 mm</b>	<b>RU 5182-02</b>
3	<b>138 mm</b>	<b>160 mm</b>	<b>RU 5182-03</b>
4	<b>168 mm</b>	<b>190 mm</b>	<b>RU 5182-04</b>



**RU 5182-31** Satz in Etui, mit 3 Spateln,  
bestehend aus:

*Set in case, with 3 blades,  
consisting of:*

**RU 5180-10**  
**RU 5182-01**  
**RU 5182-02**  
**RU 5182-03**  
**RU 5182-99** Etui/case

**Wisconsin-Foregger**

**LARYNGOSKOPE  
LARYNGOSCOPES**



**Laryngoskopie-Spatel nach Negus  
Negus Laryngoscope Blades**

Fig.	Nutzlänge working length	Gesamtlänge length	
1	<b>73 mm</b>	<b>95 mm</b>	<b>RU 5184-01</b>
2	<b>88 mm</b>	<b>110 mm</b>	<b>RU 5184-02</b>
3	<b>108 mm</b>	<b>130 mm</b>	<b>RU 5184-03</b>
4	<b>138 mm</b>	<b>160 mm</b>	<b>RU 5184-04</b>



**RU 5184-20** Satz in Etui, mit 2 Spateln,  
bestehend aus:

*Set in case, with 2 blades,  
consisting of:*

**RU 5185-10**  
**RU 5184-01**  
**RU 5184-03**  
**RU 5180-99** Etui/case

**LARYNGOSKOPE  
LARYNGOSCOPES**



**Laryngoskopie-Spatel nach Miller  
Miller Laryngoscope Blades**

Fig. Nutzlänge  
working length Gesamtlänge  
length

0	<b>53 mm</b>	<b>75 mm</b>	<b>RU 5185-00</b>
1	<b>78 mm</b>	<b>100 mm</b>	<b>RU 5185-01</b>
2	<b>133 mm</b>	<b>155 mm</b>	<b>RU 5185-02</b>
3	<b>173 mm</b>	<b>195 mm</b>	<b>RU 5185-03</b>
4	<b>183 mm</b>	<b>205 mm</b>	<b>RU 5185-04</b>



**RU 5185-30** Satz in Etui, mit 3 Spateln,  
bestehend aus:

*Set in case, with 3 blades,  
consisting of:*

**RU 5180-10**  
**RU 5185-02**  
**RU 5185-03**  
**RU 5185-04**  
**RU 5185-99** Etui/case

**RU 5185-40** Satz in Etui, mit 4 Spateln,  
bestehend aus:

*Set in case, with 4 blades,  
consisting of:*

**RU 5180-10**  
**RU 5185-01**  
**RU 5185-02**  
**RU 5185-03**  
**RU 5185-04**  
**RU 5185-99** Etui/case

**Miller**

## KALTLICHT-LARYNGOSKOPE MIT HALOGEN UND FIBER-OPTIK LARYNGOSCOPES WITH HALOGEN AND FIBER OPTIC ILLUMINATION

ohne Batterien/*without batteries*



mit Trafoanschluß  
*with transformer connection*

**RU 5188-10/01**  
für NC-Akku RU 5180-12 und  
Transformator 220 V, RU 5180-13  
bzw. 110 V RU 5180-14, siehe Seite 384

*for NC-accumulator RU 5180-12  
and transformer 220 V, RU 5180-13  
resp. 110 V RU 5180-14, see page 384*

Ø 30 mm  
**RU 5188-10**

Batteriegriff, für  
konventionelle Batterien  
*Battery handle, for  
conventional batteries*



Ø 18 mm  
**RU 5188-12**

Batteriegriff, für  
konventionelle Batterien  
*Battery handle, for  
conventional batteries*



**McIntosh Fiber-Optic**

### Laryngoskopie-Spatel nach McIntosh *McIntosh Laryngoscope Blades*

Fig.	Nutzlänge <i>working length</i>	Gesamtlänge <i>length</i>	
0	<b>53 mm</b>	<b>75 mm</b>	<b>RU 5188-00</b>
1	<b>68 mm</b>	<b>90 mm</b>	<b>RU 5188-01</b>
2	<b>88 mm</b>	<b>110 mm</b>	<b>RU 5188-02</b>
3	<b>108 mm</b>	<b>130 mm</b>	<b>RU 5188-03</b>
4	<b>128 mm</b>	<b>150 mm</b>	<b>RU 5188-04</b>



Halogenlampe 2,5 V  
*Halogen lamp 2.5 V*

**RU 5188-08**

**KALTLICHT-LARYNGOSKOPE MIT HALOGEN UND FIBER-OPTIK**  
**LARYNGOSCOPES WITH HALOGEN AND FIBER OPTIC ILLUMINATION**



**McIntosh Fiber-Optic**

**RU 5188-30** Satz in Etui, mit 3 Spateln,  
bestehend aus:

*Set in case, with 3 blades,  
consisting of:*

**RU 5188-10**  
**RU 5188-02**  
**RU 5188-03**  
**RU 5188-04**  
**RU 5180-99** Etui/case

**RU 5188-40** Satz in Etui, mit 4 Spateln,  
bestehend aus:

*Set in case, with 4 blades,  
consisting of:*

**RU 5188-10**  
**RU 5188-01**  
**RU 5188-02**  
**RU 5188-03**  
**RU 5188-04**  
**RU 5180-99** Etui/case



**KALTLICHT-LARYNGOSKOPE MIT HALOGEN UND FIBER-OPTIK  
LARYNGOSCOPES WITH HALOGEN AND FIBER OPTIC ILLUMINATION**



**Miller Fiber-Optic**

**Laryngoskopie-Spatel nach Miller  
Miller Laryngoscope Blades**

Fig.	Nutzlänge <i>working length</i>	Gesamtlänge <i>length</i>	
0	<b>53 mm</b>	<b>75 mm</b>	<b>RU 5189-00</b>
1	<b>78 mm</b>	<b>100 mm</b>	<b>RU 5189-01</b>
2	<b>133 mm</b>	<b>155 mm</b>	<b>RU 5189-02</b>
3	<b>173 mm</b>	<b>195 mm</b>	<b>RU 5189-03</b>
4	<b>183 mm</b>	<b>205 mm</b>	<b>RU 5189-04</b>



**Miller Fiber-Optic**

**RU 5189-30** Satz in Etui, mit 3 Spateln, bestehend aus:

*Set in case, with 3 blades, consisting of:*

**RU 5188-10**  
**RU 5189-02**  
**RU 5189-03**  
**RU 5189-04**  
**RU 5185-99** Etui/case

**RU 5189-40** Satz in Etui, mit 4 Spateln, bestehend aus:

*Set in case, with 4 blades, consisting of:*

**RU 5188-10**  
**RU 5189-01**  
**RU 5189-02**  
**RU 5189-03**  
**RU 5189-04**  
**RU 5185-99** Etui/case

**RU 5189-50** Satz in Etui, mit 5 Spateln, bestehend aus:

*Set in case, with 5 blades, consisting of:*

**RU 5188-10**  
**RU 5189-00**  
**RU 5189-01**  
**RU 5189-02**  
**RU 5189-03**  
**RU 5189-04**  
**RU 5185-99** Etui/case

**BRUSTSTÜTZE, OPERATIONS-LARYNGOSKOPE**  
**CHEST-SUPPORT, OPERATION LARYNGOSCOPES**



Bruststütze für Erwachsene, komplett mit Stützstange, 34 cm/13½"  
Chest support for adults, complete with support rod, 34 cm/13½"

**RU 5170-01**

Stützstange für Kinder, 24 cm/9½"  
Chest support for children, 24 cm/9½"

**RU 5170-02**

Stützstange für Erwachsene, 34 cm/13½"  
Chest support for adults, 34 cm/13½"

**RU 5170-03**

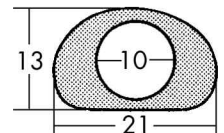
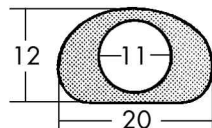

rostfreier Edelstahl  
Rohr – innen matt,  
          außen glänzend  
Griff – ganz matt  
*stainless steel*  
*tube – inner surface matt*  
          *outer surface polished*  
*handle – matt*

Fig. 1



135 mm

**RU 5170-11**

Fig. 2



152 mm

**RU 5170-12**

**OPERATIONSLARYNGOSKOPE  
OPERATION LARYNGOSCOPES**

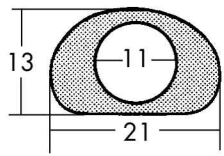

Fig. 3



**RU 5170-13**

rostfreier Edelstahl.  
Rohr – innen matt,  
außen glänzend  
Griff – ganz matt  
stainless steel  
tube – inner surface matt  
outer surface polished  
handle – matt

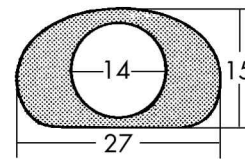

Fig. 4



**RU 5170-14**

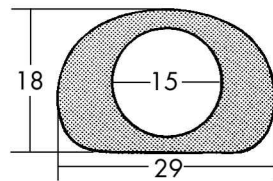
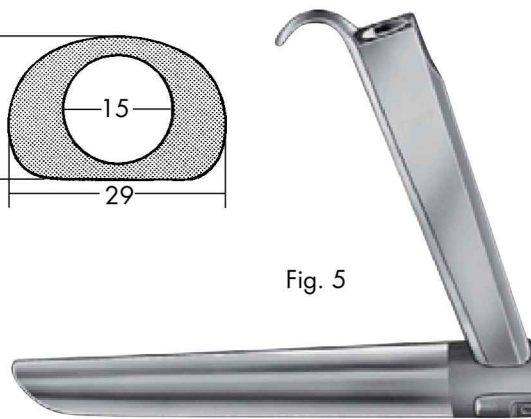

Fig. 5



**RU 5170-15**

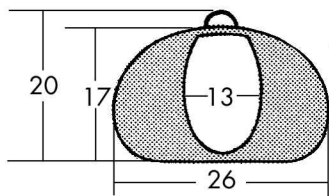

Fig. 6



**RU 5170-16**

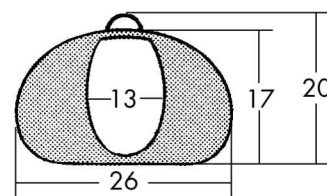

Fig. 7



**RU 5170-17**

**LARYNGOSKOPE, ZUBEHÖR**  
**LARYNGOSCOPES, ACCESSORIES**



für/for Fig. 1 und Fig. 2

**RU 5170-23**



für/for Fig. 3 bis Fig. 6

**RU 5170-24**



für/for Fig. 7

**RU 5170-25**

Fiberglas-Lichtträger für Laryngoskope  
*Fiberglass light guide for laryngoscopes*

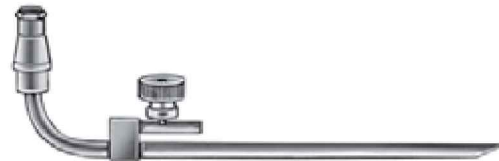

für/for Fig. 1 bis Fig. 7

**RU 5170-31**

Injektionskanüle für Laryngoskope  
*Injection drain tube for laryngoscopes*

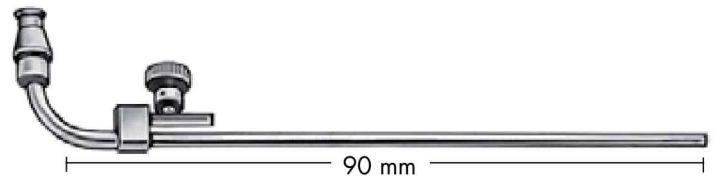

für/for Fig. 3 bis Fig. 7

**RU 5170-33**

Rauchabsaugrohr für Laryngoskope  
*Suction tube for laryngoscopes*

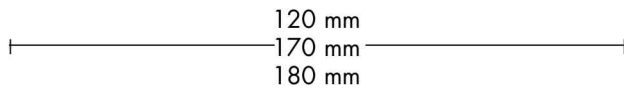

**Jackson**  
Laryngoskope  
*Laryngoscopes*

für Erwachsene/for adults	180 mm	<b>RU 5178-01</b>
für Kinder/for children	170 mm	<b>RU 5178-02</b>
für Säuglinge/for babies	120 mm	<b>RU 5178-03</b>

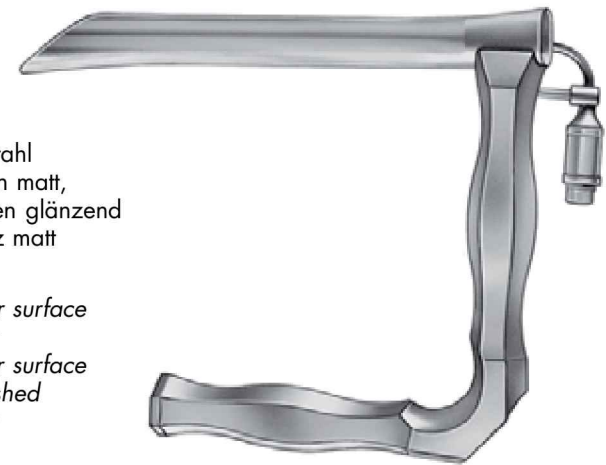
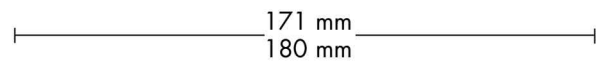

rostfreier Edelstahl  
Rohr – innen matt,  
          außen glänzend  
Griff – ganz matt  
  
stainless steel  
tube – inner surface  
          matt  
          outer surface  
          polished  
handle – matt

**Holinger**  
Laryngoskope  
*Laryngoscope*

180 mm	<b>RU 5178-11</b>
171 mm	<b>RU 5178-12</b>

**OPERATIONSLARYNGOSKOPE, SPREIZBAR**  
**OPERATION LARYNGOSCOPES, SPREADABLE**



rostfreier Edelstahl  
Rohr – innen matt,  
außen glänzend  
Griff – ganz matt  
*stainless steel*  
*tube – inner surface matt*  
*outer surface polished*  
*handle – matt*

Spreizbar/spreadable

Länge/length	Außendurchmesser Outer diameter	Innendurchmesser Inner diameter	
135 mm	20 x 12 mm	11 mm	<b>RU 5171-11</b>
152 mm	21 x 13 mm	10 mm	<b>RU 5171-12</b>
182 mm	21 x 13 mm	11 mm	<b>RU 5171-13</b>
172 mm	27 x 15 mm	14 mm	<b>RU 5171-14</b>
172 mm	29 x 18 mm	15 mm	<b>RU 5171-15</b>
182 mm	26 x 17/20 mm	13 mm	<b>RU 5171-16</b>
222 mm	26 x 17/20 mm	13 mm	<b>RU 5171-17</b>



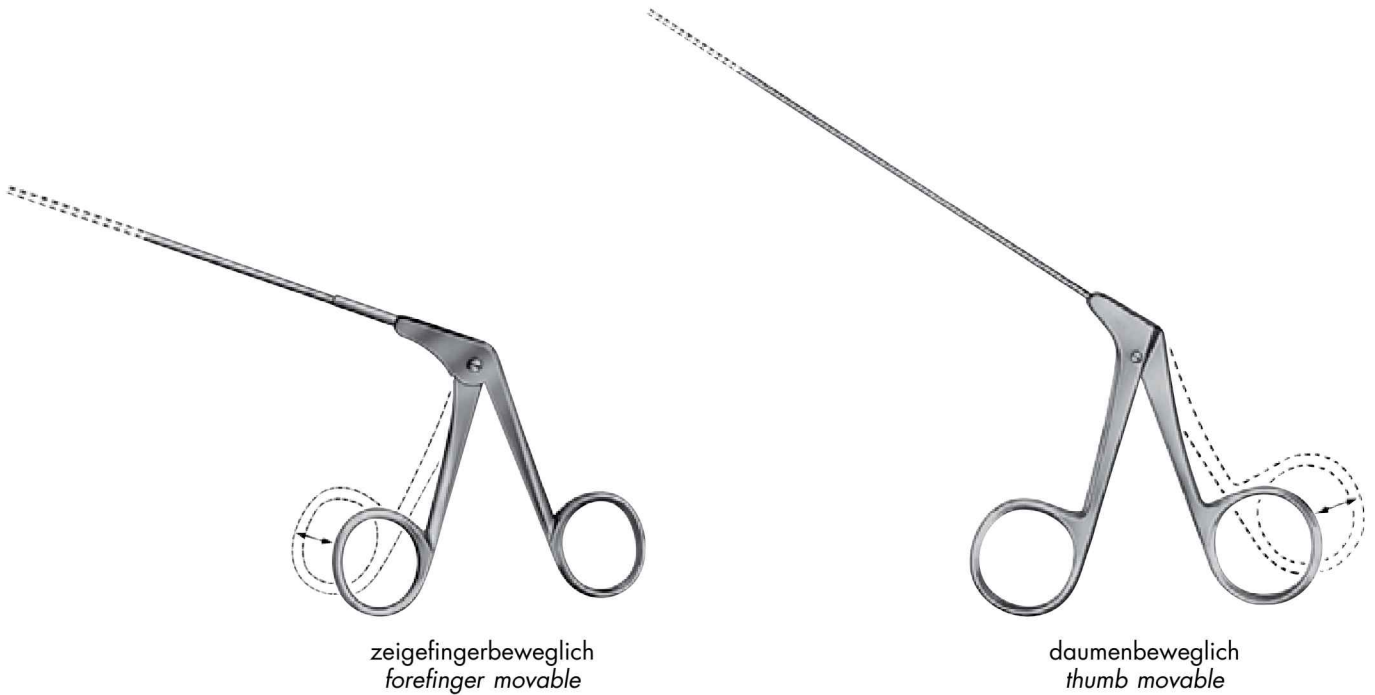

**ZANGEN ZUR ENDOLARYNGEALEN MIKROCHIRURGIE  
FORCEPS FOR ENDOLARYNGEAL MICROSURGERY**

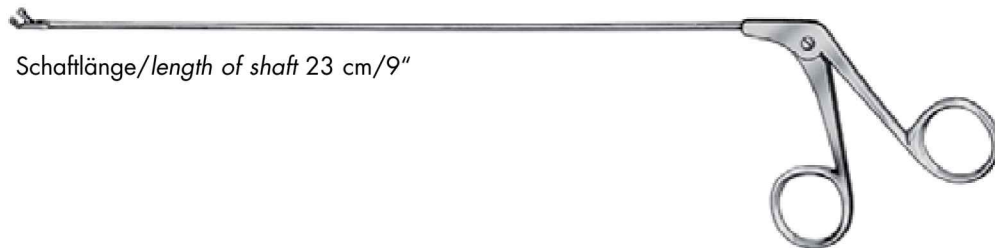

Instrumentarium zur endolaryngealen Mikrochirurgie mit neuem, konisch zulaufendem Schaft für hohe Stabilität bei gleichzeitig optimaler Sicht.

*Laryngeal instruments for endolaryngeal microsurgery with new conical shaft for high stability and optimal view.*









Löffelzangen Cutting forceps	Ø 4 mm	zeigefingerbeweglich forefinger movable
	gerade straight	<b>RU 8650-00/40</b>
	aufwärts gebogen curved upwards	<b>RU 8650-00/43</b>
	rechts gebogen curved right	<b>RU 8650-00/45</b>
	links gebogen curved left	<b>RU 8650-00/46</b>

**ZANGEN ZUR ENDOLARYNGEALEN MIKROCHIRURGIE  
FORCEPS FOR ENDOLARYNGEAL MICROSURGERY**



Schaftlänge/length of shaft 23 cm/9"

Mikroscheren Micro scissors	Ø 2 mm	zeigefingerbeweglich forefinger movable	daumenbeweglich thumb movable
 gerade straight		<b>RU 8650-03/01</b>	<b>RU 8650-04/01</b>
 gerade horizontal straight horizontal		<b>RU 8650-03/02</b>	<b>RU 8650-04/02</b>
 45° aufgewinkelt angled 45°		<b>RU 8650-03/03</b>	<b>RU 8650-04/03</b>
 15° aufgewinkelt angled 15°		<b>RU 8650-03/04</b>	<b>RU 8650-04/04</b>
 rechts gebogen curved right		<b>RU 8650-03/05</b>	<b>RU 8650-04/05</b>
 links gebogen curved left		<b>RU 8650-03/06</b>	<b>RU 8650-04/06</b>







Schaftlänge/length of shaft 18 cm/7"

Mikroscheren Micro scissors	Ø 2 mm	zeigefingerbeweglich forefinger movable	daumenbeweglich thumb movable
 gerade straight		<b>RU 8649-03/01</b>	<b>RU 8649-04/01</b>
 45° aufgewinkelt angled 45°		<b>RU 8649-03/03</b>	<b>RU 8649-04/03</b>
 rechts gebogen curved right		<b>RU 8649-03/05</b>	<b>RU 8649-04/05</b>
 links gebogen curved left		<b>RU 8649-03/06</b>	<b>RU 8649-04/06</b>

**ZANGEN ZUR ENDOLARYNGEALEN MIKROCHIRURGIE  
FORCEPS FOR ENDOLARYNGEAL MICROSURGERY**



Schaftlänge/length of shaft 23 cm/9"

Mikro-Fasszangen Micro forceps	Ø 2 mm	zeigefingerbeweglich forefinger movable	daumenbeweglich thumb movable
	gerade straight	<b>RU 8650-03/11</b>	<b>RU 8650-04/11</b>
	aufwärts gebogen curved upwards	<b>RU 8650-03/13</b>	<b>RU 8650-04/13</b>
	rechts gebogen curved right	<b>RU 8650-03/15</b>	<b>RU 8650-04/15</b>
	links gebogen curved left	<b>RU 8650-03/16</b>	<b>RU 8650-04/16</b>
	aufwärts gebogen rechts curved upwards right	<b>RU 8650-03/18</b>	<b>RU 8650-04/18</b>
	aufwärts gebogen links curved upwards left	<b>RU 8650-03/19</b>	<b>RU 8650-04/19</b>

Schaftlänge/length of shaft 18 cm/7"







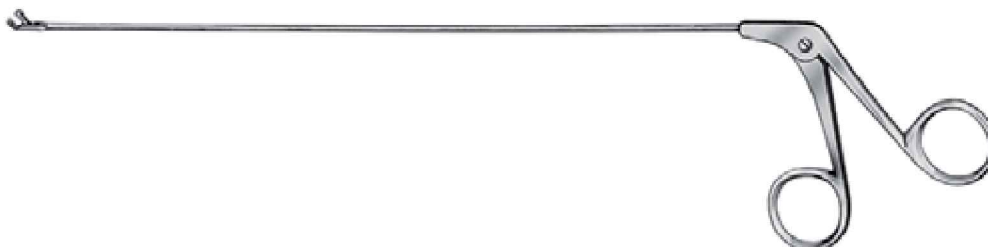

	gerade straight	<b>RU 8649-03/11</b>	<b>RU 8649-04/11</b>
---	--------------------	----------------------	----------------------





## ZANGEN ZUR ENDOLARYNGEALEN MIKROCHIRURGIE FORCEPS FOR ENDOLARYNGEAL MICROSURGERY





Schaftlänge/length of shaft 23 cm/9"

Mikro-Löffelzangen Micro cutting forceps	Ø 2 mm	zeigefingerbeweglich forefinger movable	daumenbeweglich thumb movable
	gerade straight	<b>RU 8650-03/21</b>	<b>RU 8650-04/21</b>
	aufwärts gebogen curved upwards	<b>RU 8650-03/23</b>	<b>RU 8650-04/23</b>
	rechts gebogen curved right	<b>RU 8650-03/25</b>	<b>RU 8650-04/25</b>
	links gebogen curved left	<b>RU 8650-03/26</b>	<b>RU 8650-04/26</b>
	aufwärts gebogen rechts curved upwards right	<b>RU 8650-03/30</b>	<b>RU 8650-04/30</b>
	aufwärts gebogen links curved upwards left	<b>RU 8650-03/31</b>	<b>RU 8650-04/31</b>
	horizontal rechts horizontal right	<b>RU 8650-03/32</b>	<b>RU 8650-04/32</b>
	horizontal links horizontal left	<b>RU 8650-03/33</b>	<b>RU 8650-04/33</b>

Schaftlänge/length of shaft 18 cm/7"

	gerade straight	<b>RU 8649-03/21</b>	<b>RU 8649-04/21</b>
	aufwärts gebogen curved upwards	<b>RU 8649-03/23</b>	<b>RU 8649-04/23</b>



Mikro-Löffelzangen Micro cutting forceps	Ø 3 mm		
	gerade straight	<b>RU 8649-05/21</b>	<b>RU 8649-06/21</b>
	aufwärts gebogen curved upwards	<b>RU 8649-05/23</b>	<b>RU 8649-06/23</b>

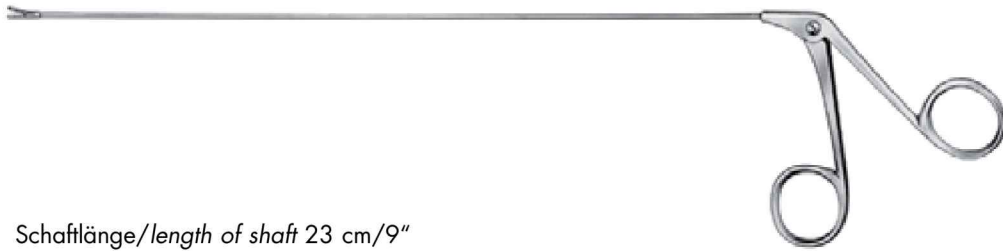





## ZANGEN ZUR ENDOLARYNGEALEN MIKROCHIRURGIE FORCEPS FOR ENDOLARYNGEAL MICROSURGERY

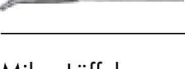

Schaftlänge/length of shaft 23 cm/9"

Mikro-Scheren Micro scissors	Ø 1 mm	zeigefingerbeweglich forefinger movable	daumenbeweglich thumb movable
	gerade straight	<b>RU 8650-11/01</b>	<b>RU 8650-12/01</b>
	aufgewinkelt 45° angled 45°	<b>RU 8650-11/03</b>	<b>RU 8650-12/03</b>
	rechts gebogen curved right	<b>RU 8650-11/05</b>	<b>RU 8650-12/05</b>
	links gebogen curved left	<b>RU 8650-11/06</b>	<b>RU 8650-12/06</b>

Mikro-Fasszangen Micro forceps	Ø 1 mm		
	gerade straight	<b>RU 8650-11/11</b>	<b>RU 8650-12/11</b>
	aufwärts gebogen curved upwards	<b>RU 8650-11/13</b>	<b>RU 8650-12/13</b>
	rechts gebogen curved right	<b>RU 8650-11/15</b>	<b>RU 8650-12/15</b>
	links gebogen curved left	<b>RU 8650-11/16</b>	<b>RU 8650-12/16</b>

Mikro-Löffelzangen Micro cutting forceps	Ø 1 mm		
	gerade straight	<b>RU 8650-11/21</b>	<b>RU 8650-12/21</b>
	aufwärts gebogen curved upwards	<b>RU 8650-11/23</b>	<b>RU 8650-12/23</b>
	rechts gebogen curved right	<b>RU 8650-11/25</b>	<b>RU 8650-12/25</b>
	links gebogen curved left	<b>RU 8650-11/26</b>	<b>RU 8650-12/26</b>
	aufwärts gebogen rechts curved upwards right	<b>RU 8650-11/30</b>	<b>RU 8650-12/30</b>
	aufwärts gebogen links curved upwards left	<b>RU 8650-11/31</b>	<b>RU 8650-12/31</b>

Schaftlänge/length of shaft 18 cm/7"

	aufwärts gebogen curved upwards	<b>RU 8649-11/23</b>	<b>RU 8649-12/23</b>
---	------------------------------------	----------------------	----------------------

**ZANGEN ZUR ENDOLARYNGEALEN MIKROCHIRURGIE**  
**FORCEPS FOR ENDOLARYNGEAL MICROSURGERY**

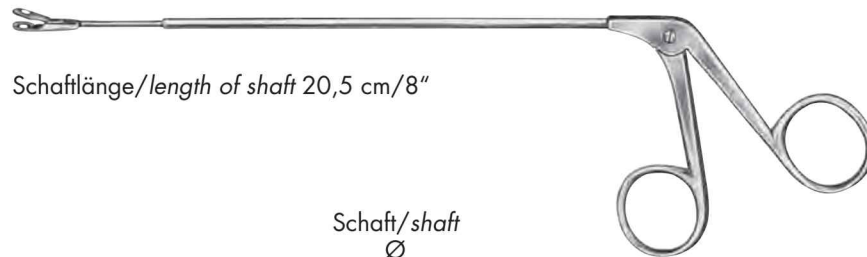

Schaftlänge/length of shaft 20,5 cm/8"

Schaft/shaft  
Ø

**RU 8651-01**



2,5 mm

Zängchen mit gefenesterten Maulteilen  
scharf, gerade  
*Cutting forceps, with fenestrated jaw,  
sharp, straight*

**RU 8651-02**



2,0 mm

Zängchen mit ovalem Löffel  
2 x 3 mm, gerade  
*Cup-shaped forceps, oval 2 x 3 mm, straight*

**RU 8651-05**



3,0 mm

Zängchen zur Probeexzision, 4 x 4,5 mm, 90° gewinkelt  
*Biopsy punch, 4 x 4,5 mm, 90° angled*

Schaftlänge/length of shaft 23 cm/9"

**RU 8651-10**



2,5 mm

Fasszange, kräftiges Modell  
*Grasping forceps, strong*

**RU 8651-11**



2,5 mm

Zange mit Hechtmaul  
*Alligator grasping forceps*

**RU 8651-20**



2,7 mm

Zange mit ovalem Löffel, kräftig  
*Forceps, oval, strong*

**RU 8651-21**



2,5 mm

Zange mit Löffel 4 mm, kräftig  
*Forceps, strong*

Schaftlänge 23 cm/9"  
length of shaft

**RU 8651-40**



Nadelhalter mit Sperre  
*Needleholder with ratchet*

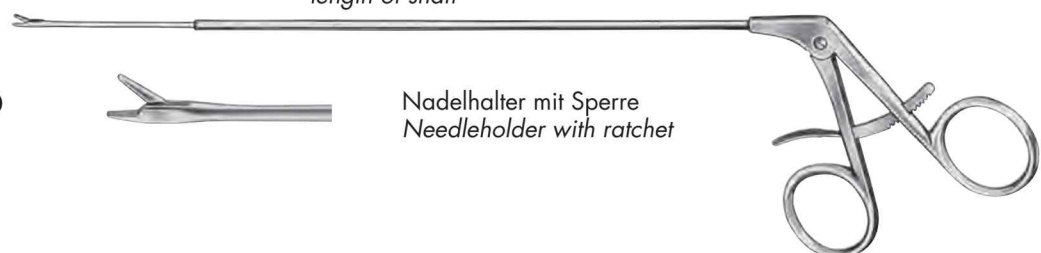

**LARYNGOSKOPIE-INSTRUMENTE**  
**LARYNGEAL INSTRUMENTS**

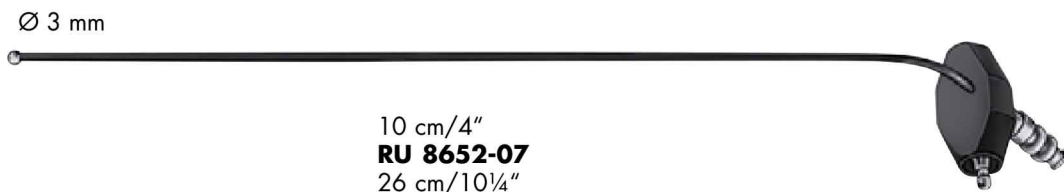

Ø 3 mm

10 cm/4"

**RU 8652-07**

26 cm/10¼"

**RU 8652-08**

Koagulations- und  
Saugkanüle, Luer-Lock  
*Insulated cannula  
for suction and coagulation  
with Luer-Lock cone*

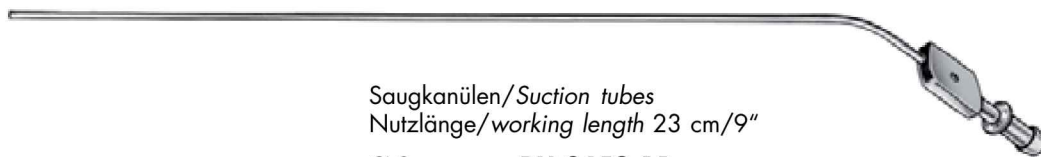

Saugkanülen/Suction tubes  
Nutzlänge/working length 23 cm/9"

Ø 2 mm

**RU 8652-11**

Ø 2,5 mm

**RU 8652-12**

Ø 3 mm

**RU 8652-13**

**LARYNGOSKOPIE-INSTRUMENTE**  
**LARYNGEAL INSTRUMENTS**

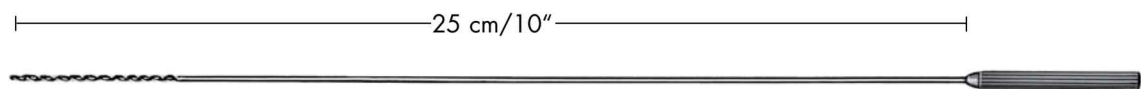
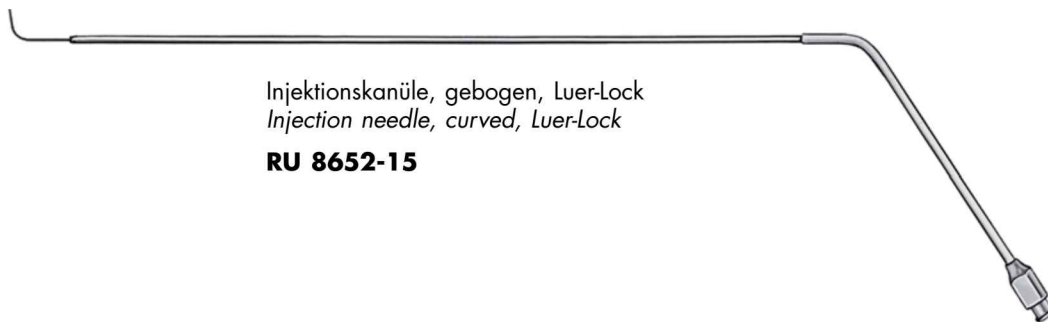
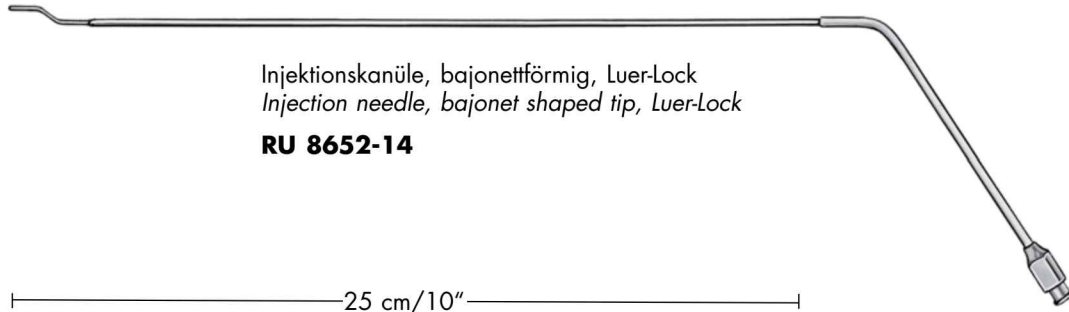

Watteträger, gerade  
*Cotton applicator, straight*

**RU 8653-00**

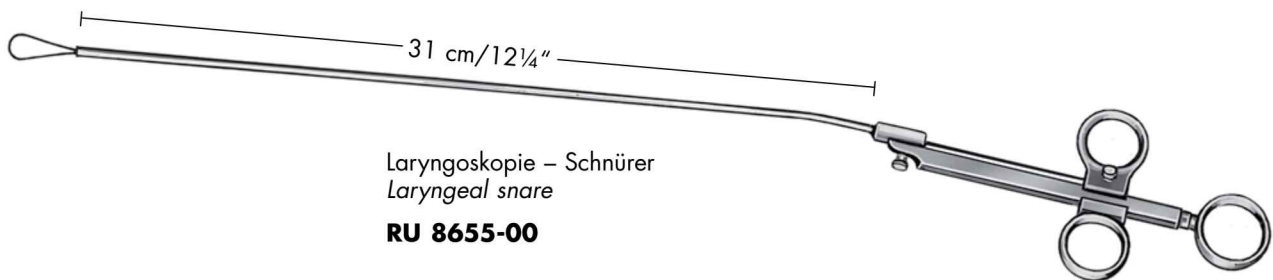

0,3 mm **RU 8024-10**      0,3 mm **RU 8024-10/00**

Packung à 12 Stück  
*Package of 1 dozen each*

Packung à 100 Stück  
*Package of 100 pieces*

**LARYNGOSKOPIE-INSTRUMENTE**  
**LARYNGEAL INSTRUMENTS**

Handgriff für Stabinstrumente  
Handle for stick instruments

**RU 8652-00**



**RU 8652-21**  
Messer, oval, gerade  
Knife, oval, straight



**RU 8652-22**  
Messer, 45°  
Knife, 45°



**RU 8652-23**  
Messer, gebogen, spitz  
Knife, curved, pointed



**RU 8652-24**  
Messer, gerade, spitz  
Knife, straight, pointed



**RU 8652-25**  
Messer, rund, gebogen  
Knife, round, curved



**RU 8652-26**  
Messer, rund, vertikal  
Knife, round, vertical cutting



**RU 8652-27**  
Häkchen, stumpf, mit Sondenknopf  
Hook, blunt, with probe end



**RU 8652-28**  
Häkchen, scharf  
Hook, sharp



**RU 8652-29**  
Häkchen, 90°, mit Sondenknopf  
Hook, with probe end, angled 90°



**RU 8652-30**  
Nadel, rechts gebogen  
Needle, curved right



**RU 8652-31**  
Nadel, links gebogen  
Needle, curved left



**RU 8652-32**  
Saug-Raspatorium  
Suction raspatory



**RU 8652-33**  
Fadengabel  
Knot tier



**RU 8652-34**  
Messer, längs, oval  
Knife, vertical, oval blade



**RU 8652-35**  
Messer, 45° abgewinkelt  
Knife, 45° angled

**WATTETRÄGER  
LARYNGEAL APPLICATORS**

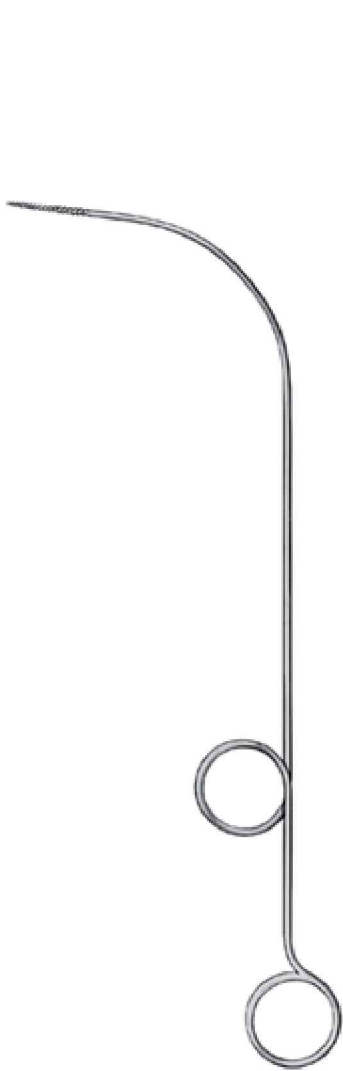

**Pelteson**  
23 cm/9"  
**RU 4921-23**

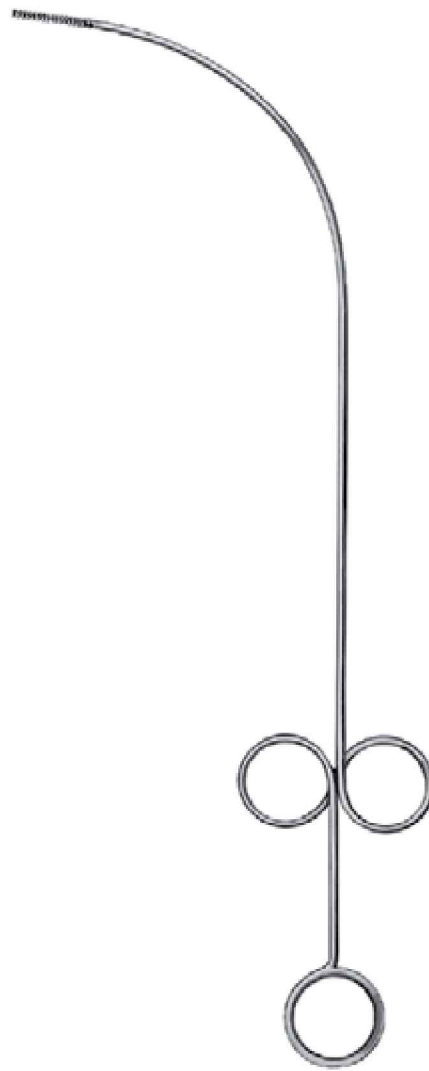

**Fein**  
28 cm/11"  
**RU 4922-28**



**Killian**  
25 cm/10"  
**RU 4922-50**

**KEHLKOPFKANÜLE, SPRITZEN, ZERSTÄUBER  
LARYNGEAL NEEDLE, SYRINGES, ATOMIZER**



**RU 5283-01**

**Luer-Lock**



Mit drehbaren Ringen  
With rotatable rings

ml/cc	Spritze Syringe	Zylinder Cylinder
2	<b>RU 5285-02</b>	<b>RU 5285-02/Z</b>
5	<b>RU 5285-05</b>	<b>RU 5285-05/Z</b>
10	<b>RU 5285-10</b>	<b>RU 5285-10/Z</b>



Verchromter Zerstäuber, inkl. 12 ml-Flakon  
für Kehlkopf, abwärts gebogen

*Chromium-plated atomizer incl. 12 ml glass bottle  
for larynx, curved downwards*

**RU 8025-03**

Ersatzflakon 12 ml, allein  
*Spare glass bottle 12 ml, only*

**RU 8025-12**



**UNIVERSALGRIFF UND VERLÄNGERUNGSRÖHRE**  
**UNIVERSAL HANDLE AND TUBES**



**Huber**  
**RU 8630-00**



Verlängerungsrohr, gerade  
*tube, straight*

20 cm/8"  
30 cm/12"  
40 cm/16"  
50 cm/20"  
60 cm/24"

**RU 8632-20**  
**RU 8632-30**  
**RU 8632-40**  
**RU 8632-50**  
**RU 8632-60**

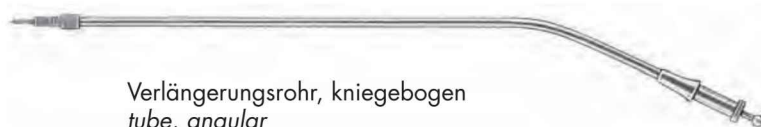

Verlängerungsrohr, kniegebogen  
*tube, angular*

20 cm/8"  
30 cm/12"  
40 cm/16"  
50 cm/20"  
60 cm/24"

**RU 8633-20**  
**RU 8633-30**  
**RU 8633-40**  
**RU 8633-50**  
**RU 8633-60**

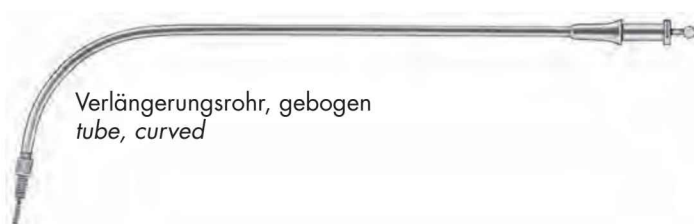

Verlängerungsrohr, gebogen  
*tube, curved*

20 cm/8"

**RU 8634-20**

**ZANGENAUFsätze FÜR GRIFf UND VERLÄNGERUNGSROHR (S. 407)**  
**FORCEPS TIPS FOR HANDLE AND TUBES (P. 407)**



**Seiffert**  
**RU 8636-01**



**Fränkel**  
**RU 8637-01**



- Bruenings**
- 2 mm Ø **RU 8639-01**
  - 3 mm Ø **RU 8639-02**
  - 4 mm Ø **RU 8639-02/04**



**Bruenings**  
*aufgewinkelt/angled up*

- 2 mm **RU 8639-03**
- 3 mm **RU 8639-03/03**
- 4 mm **RU 8639-03/04**



**Bruenings**

- **RU 8639-04**
- **RU 8639-04/03**
- **RU 8639-04/04**



**Krause**

- **RU 8641-01**
- **RU 8641-02**



- Krause**
- **RU 8642-01**
  - **RU 8642-02**



- Cordes**
- **RU 8643-01**
  - **RU 8643-02**
  - **RU 8643-03**
  - **RU 8643-04**



- Schumacher**  
**RU 8644-01**



- Cordes**
- **RU 8645-01**
  - **RU 8645-02**



**Fränkel**  
**RU 8648-01**

**KEHLKOPFSPIEGEL UND GRIFFE  
LARYNGEAL MIRRORS AND HANDLES**



Fig. Ø mm

<b>RU 8660-06</b>	000	6	<b>RU 8662-06</b>
<b>RU 8660-08</b>	00	8	<b>RU 8662-08</b>
<b>RU 8660-10</b>	0	10	<b>RU 8662-10</b>
<b>RU 8660-12</b>	1	12	<b>RU 8662-12</b>
<b>RU 8660-14</b>	2	14	<b>RU 8662-14</b>
<b>RU 8660-16</b>	3	16	<b>RU 8662-16</b>
<b>RU 8660-18</b>	4	18	<b>RU 8662-18</b>
<b>RU 8660-20</b>	5	20	<b>RU 8662-20</b>
<b>RU 8660-22</b>	6	22	<b>RU 8662-22</b>
<b>RU 8660-24</b>	7	24	<b>RU 8662-24</b>
<b>RU 8660-26</b>	8	26	<b>RU 8662-26</b>
<b>RU 8660-28</b>	9	28	<b>RU 8662-28</b>
<b>RU 8660-30</b>	10	30	<b>RU 8662-30</b>

**Michel**  
25 cm/10"

Ø mm	kpl./cpl.	Spiegel allein/ mirror only
10	<b>RU 8664-10</b>	<b>RU 8664-40</b>
12	<b>RU 8664-12</b>	<b>RU 8664-42</b>
14	<b>RU 8664-14</b>	<b>RU 8664-44</b>
16	<b>RU 8664-16</b>	<b>RU 8664-46</b>
18	<b>RU 8664-18</b>	<b>RU 8664-48</b>

**Spiegelgriffe**  
**Mirror handles**



11 cm/4<sup>3</sup>/<sub>8</sub>"  
**RU 8666-01**



10,5 cm/4<sup>1</sup>/<sub>8</sub>"  
**RU 8666-02**

**KEHLKOPFZANGEN  
LARYNGEAL FORCEPS**

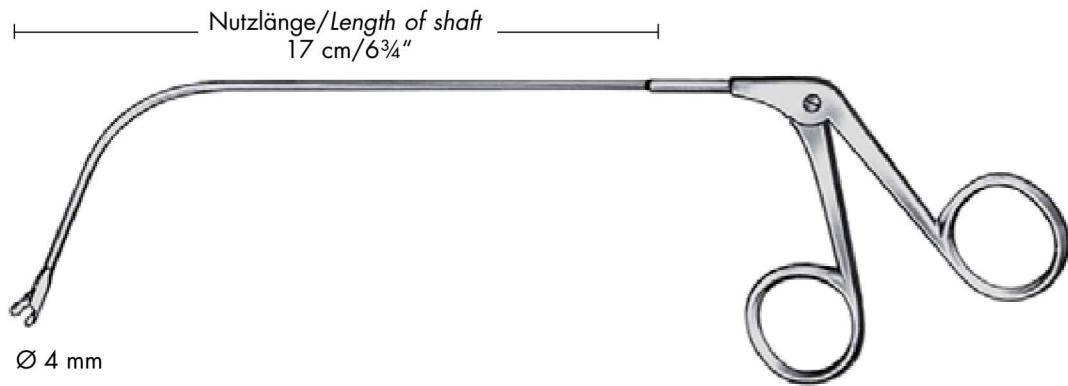

**RU 8688-01**

gerade/straight



**RU 8688-03**

rechts gebogen/curved right



**RU 8688-02**

aufgebogen/curved up



**RU 8688-04**

links gebogen/curved left

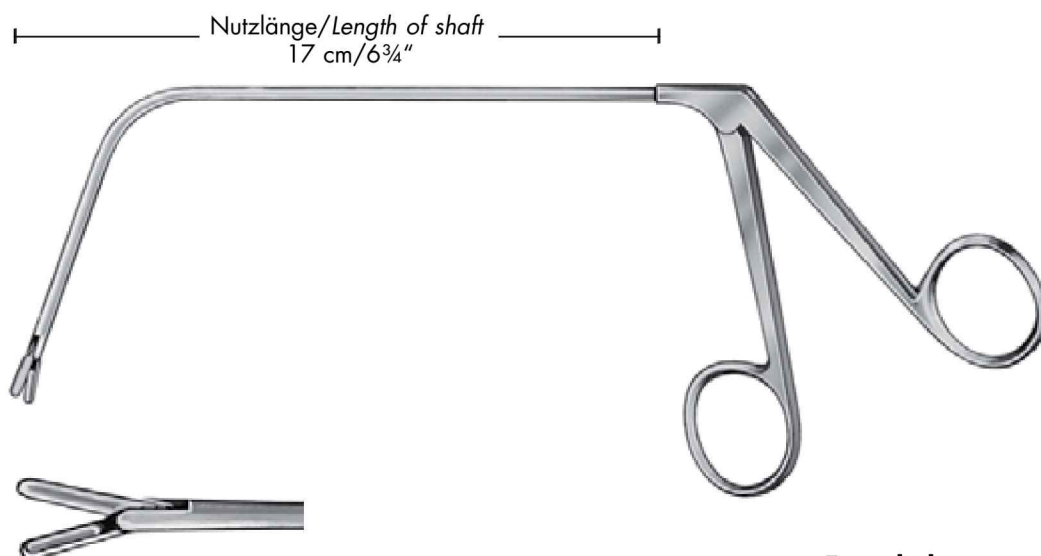

**Fraenkel**

25 cm/10"

**RU 8689-01**

Kehlkopf-Fremdkörperzange  
Laryngeal polypus forceps

**KEHLKOPFZANGEN, KEHLDECKELHALTER, LARYNGOFISSUR-SCHERE  
LARYNGEAL FORCEPS, EPIGLOTTIS RETRACTOR, LARYNGECTOMY SCISSORS**

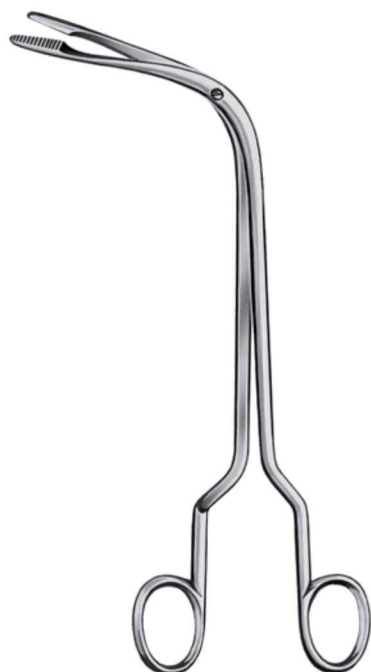

**Fraenkel**  
18 cm/7"  
**RU 8680-18**



**RU 8690-01**

**RU 8690-02**

**RU 8690-03**

**RU 8690-04**



**Jurasz**  
23 cm/9"



**Reichert**  
24 cm/9½"  
**RU 8692-24**



**Killian**  
20 cm/8"  
**RU 8695-20**