

**Implantate, Schrauben, Platten**  
**Implants, Screws and Plates**  
**Implantes, Tornillos y Placas**  
**Implants, Vis et Plaques**  
**Osteosintesi, Viti e placche**

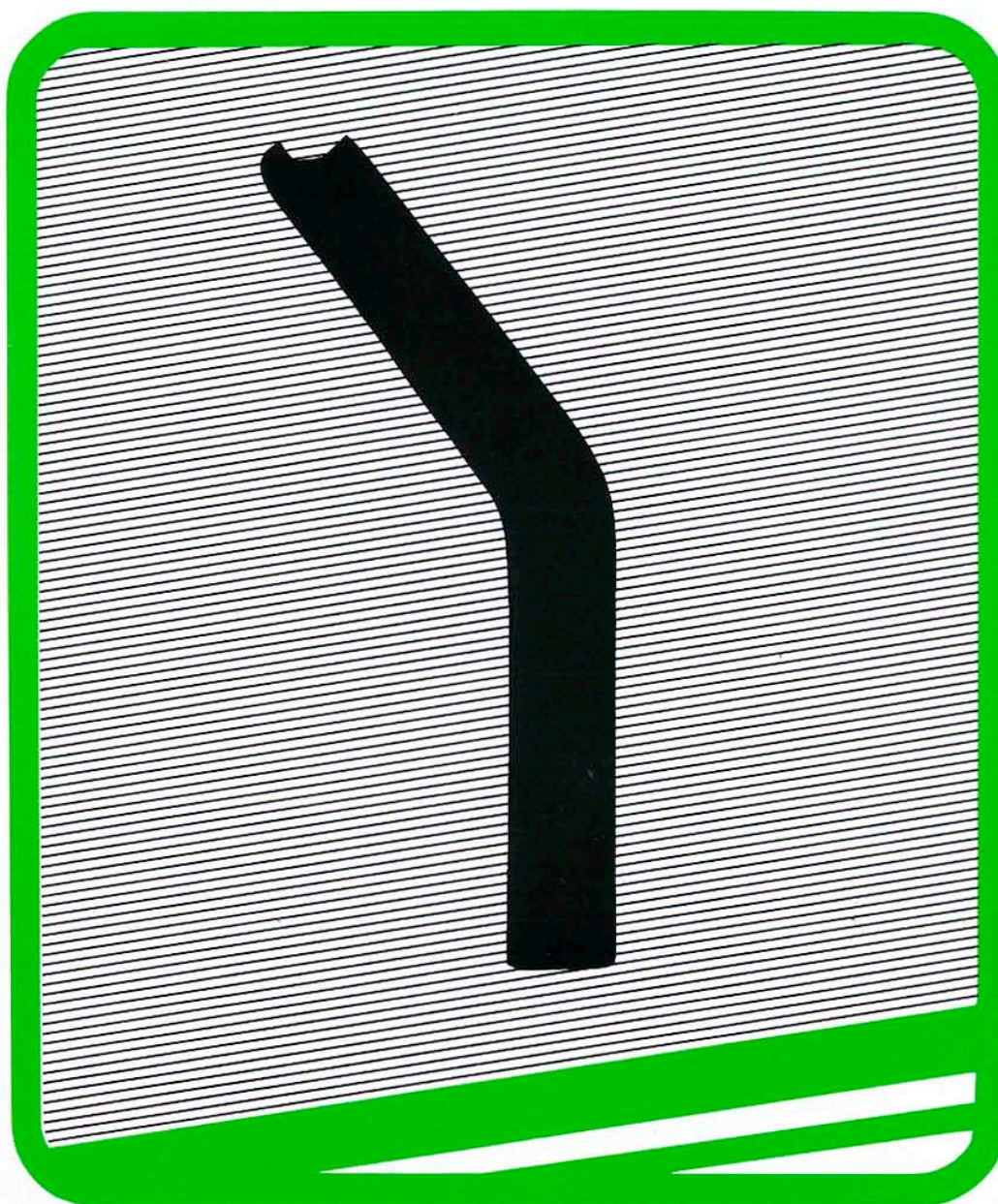



**Mini-Fragment Knochenschrauben**  
**Mini-Fragment Bone Screws**  
**Tornillos para Minifragmentos**  
**Vis à os pour mini-fragments**  
**Mini viti per frammenti**



Corticalisschrauben  
 Cortical screws  
 Tornillos corticales  
 Vis corticales  
 Viti corticali

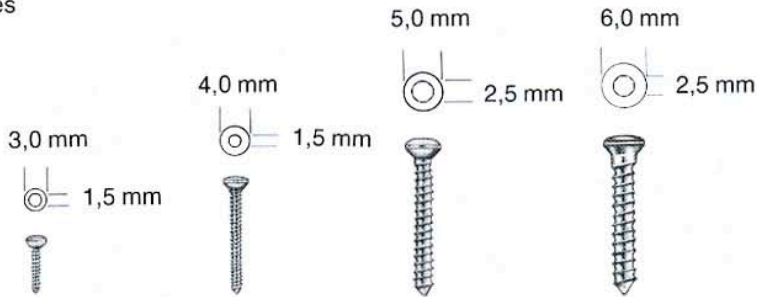

Spongiosaschrauben  
 Cancellous screws  
 Tornillos de esponjosa  
 Vis à spongieuse  
 Viti spongiosa

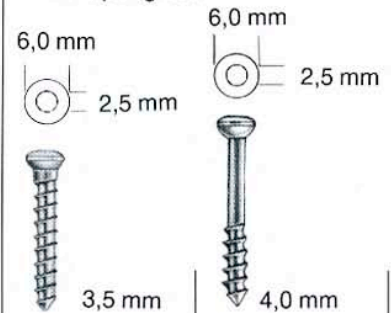

Gesamtlänge total length largo total longueur total lunghezza totale	Cortical screws		Cortical screws		Cancellous screws	
	1,5 mm	2,0 mm	2,7 mm	3,5 mm	3,5 mm	4,0 mm
			DIN 58812 ISO 5835/I	DIN 58812 ISO 5835/I		DIN 58815 ISO 5835/I
				Gewindesteigung: thread pitch: paso de rosca: pas de filet: passo del filetto: 1,25 mm	Gewindesteigung: thread pitch: paso de rosca: pas de filet: passo del filetto: 1,75 mm	
6 mm	RU 0506-006	RU 0507-006	RU 0510-006			
7 mm	RU 0506-007					
8 mm	RU 0506-008	RU 0507-008	RU 0510-008			
9 mm	RU 0506-009					
10 mm	RU 0506-010	RU 0507-010	RU 0510-010	RU 0512-010	RU 0516-010	RU 0518-010
11 mm	RU 0506-011					
12 mm	RU 0506-012	RU 0507-012	RU 0510-012	RU 0512-012	RU 0516-012	RU 0518-012
14 mm	RU 0506-014	RU 0507-014	RU 0510-014	RU 0512-014	RU 0516-014	RU 0518-014
16 mm	RU 0506-016	RU 0507-016	RU 0510-016	RU 0512-016	RU 0516-016	RU 0518-016
17 mm					RU 0516-017	
18 mm	RU 0506-018	RU 0507-018	RU 0510-018	RU 0512-018	RU 0516-018	RU 0518-018
19 mm					RU 0516-019	
20 mm		RU 0507-020	RU 0510-020	RU 0512-020	RU 0516-020	RU 0518-020
21 mm					RU 0516-021	
22 mm		RU 0507-022	RU 0510-022	RU 0512-022	RU 0516-022	RU 0518-022
23 mm					RU 0516-023	
24 mm		RU 0507-024	RU 0510-024	RU 0512-024	RU 0516-024	RU 0518-024
26 mm		RU 0507-026	RU 0510-026	RU 0512-026	RU 0516-026	RU 0518-026
28 mm		RU 0507-028	RU 0510-028	RU 0512-028	RU 0516-028	RU 0518-028
30 mm		RU 0507-030	RU 0510-030	RU 0512-030	RU 0516-030	RU 0518-030
32 mm		RU 0507-032	RU 0510-032	RU 0512-032	RU 0516-032	
34 mm		RU 0507-034				
35 mm		RU 0507-035				RU 0518-035
36 mm		RU 0507-036		RU 0512-036	RU 0516-036	
38 mm		RU 0507-038				
40 mm				RU 0512-040	RU 0516-040	RU 0518-040
45 mm				RU 0512-045	RU 0516-045	RU 0518-045
50 mm				RU 0512-050	RU 0516-050	RU 0518-050
55 mm					RU 0516-055	
60 mm					RU 0516-060	





**Große Knochenschrauben**  
**Large Bone Screws**  
**Tornillos grandes**  
**Vis à os grandes**  
**Viti per ossa, grande**



Corticalisschrauben  
 Cortical screws  
 Tornillos corticales  
 Vis corticales  
 Viti corticali



4,5 mm  
 DIN 58812  
 ISO 5835/I

Malleolarschrauben  
 Malleolar screws  
 Tornillos malleolares  
 Vis à malleole  
 Viti malleolari



3,0 mm  
 4,5 mm  
 DIN 58814  
 ISO 5835/I  
 Gewindelänge =  
 1/2 Gesamtlänge  
 length of thread =  
 1/2 of total length  
 largo de la rosca =  
 1/2 del largo total  
 longueur de filet =  
 1/2 de longueur total  
 lunghezza del filetto  
 = 1/2 della lunghezza  
 totale

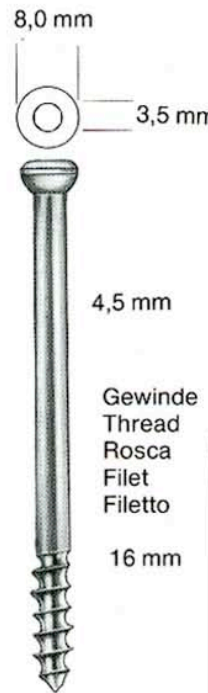

6,5 mm  
 DIN 58815  
 ISO 5835/I

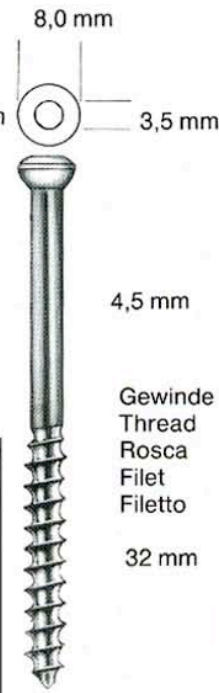

6,5 mm  
 DIN 58815  
 ISO 5835/I

Spongiaschrauben  
 Cancellous screws  
 Tornillos de esponjosa  
 Vis à spongieuse  
 Viti spongiosa

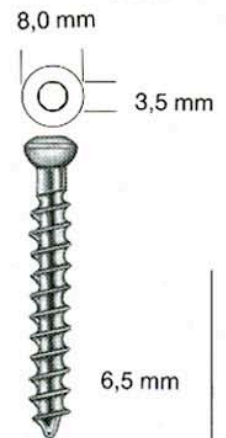

6,5 mm  
 Vollgewinde  
 Full thread  
 Rosca a todo el largo  
 Filet entier  
 tutte filettate

Gesamtlänge  
 Total length  
 Largo total  
 Longueur total  
 Lunghezza totale

14 mm	RU 0520-014				
16 mm	RU 0520-016				
18 mm	RU 0520-018				
20 mm	RU 0520-020	RU 0522-020			
22 mm	RU 0520-022				
24 mm	RU 0520-024				
25 mm		RU 0522-025			RU 0528-025
26 mm	RU 0520-026				
28 mm	RU 0520-028				
30 mm	RU 0520-030	RU 0522-030	RU 0524-030		RU 0528-030
32 mm	RU 0520-032				
34 mm	RU 0520-034				
35 mm		RU 0522-035	RU 0524-035		RU 0528-035
36 mm	RU 0520-036				
38 mm	RU 0520-038				
40 mm	RU 0520-040	RU 0522-040	RU 0524-040		RU 0528-040
42 mm	RU 0520-042				
44 mm	RU 0520-044				
45 mm		RU 0522-045	RU 0524-045	RU 0526-045	RU 0528-045
46 mm	RU 0520-046				
48 mm	RU 0520-048				
50 mm	RU 0520-050	RU 0522-050	RU 0524-050	RU 0526-050	RU 0528-050
52 mm	RU 0520-052				
54 mm	RU 0520-054				
55 mm		RU 0522-055	RU 0524-055	RU 0526-055	RU 0528-055
56 mm	RU 0520-056				
58 mm	RU 0520-058				
60 mm	RU 0520-060	RU 0522-060	RU 0524-060	RU 0526-060	RU 0528-060
62 mm	RU 0520-062				
64 mm	RU 0520-064				
65 mm		RU 0522-065	RU 0524-065	RU 0526-065	RU 0528-065
66 mm	RU 0520-066				
68 mm	RU 0520-068				
70 mm	RU 0520-070	RU 0522-070	RU 0524-070	RU 0526-070	RU 0528-070
72 mm	RU 0520-072				
74 mm	RU 0520-074				
75 mm		RU 0522-075	RU 0524-075	RU 0526-075	RU 0528-075
76 mm	RU 0520-076				
78 mm	RU 0520-078				
80 mm	RU 0520-080	RU 0522-080	RU 0524-080	RU 0526-080	RU 0528-080
85 mm	RU 0520-085	RU 0522-085	RU 0524-085	RU 0526-085	RU 0528-085
90 mm	RU 0520-090	RU 0522-090	RU 0524-090	RU 0526-090	RU 0528-090
95 mm	RU 0520-095	RU 0522-095	RU 0524-095	RU 0526-095	RU 0528-095
100 mm	RU 0520-100	RU 0522-100	RU 0524-100	RU 0526-100	RU 0528-100
105 mm		RU 0522-105	RU 0524-105	RU 0526-105	RU 0528-105
110 mm	RU 0520-110	RU 0522-110	RU 0524-110	RU 0526-110	RU 0528-110



**Hohlschrauben, selbstschneidend**  
**Cannulated Screws, selftapping**  
**Tornillos de perforación longitudinal, autoroscantes**  
**Vis cannelées, autotaraudantes**  
**Viti cannulate, autofilettanti**

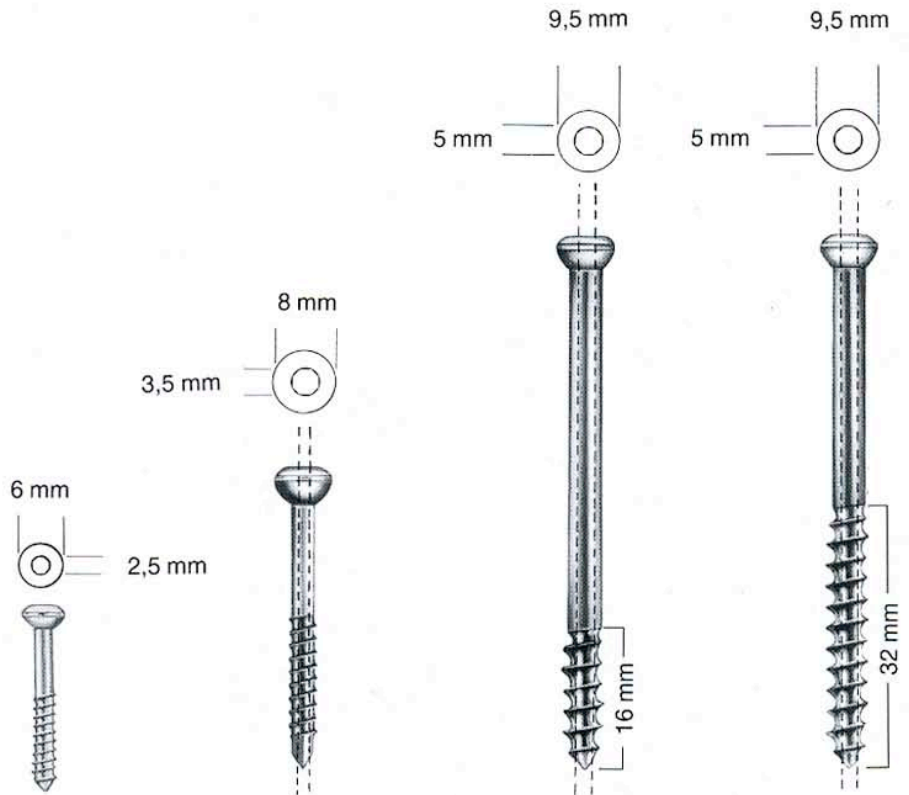

mm	Navicular Ø 4,0 mm	Malleolar Ø 4,5 mm	Ø 7 mm	Ø 7 mm
10	RU 0530-010			
12	RU 0530-012			
14	RU 0530-014			
16	RU 0530-016			
18	RU 0530-018			
20	RU 0530-020			
22	RU 0530-022			
24	RU 0530-024			
25		RU 0531-025	RU 0532-025	
26	RU 0530-026			
28	RU 0530-028			
30	RU 0530-030	RU 0531-030	RU 0532-030	
35		RU 0531-035	RU 0532-035	RU 0533-035
40		RU 0531-040	RU 0532-040	RU 0533-040
45		RU 0531-045	RU 0532-045	RU 0533-045
50		RU 0531-050	RU 0532-050	RU 0533-050
55		RU 0531-055	RU 0532-055	RU 0533-055
60			RU 0532-060	RU 0533-060
65			RU 0532-065	RU 0533-065
70			RU 0532-070	RU 0533-070
75			RU 0532-075	RU 0533-075
80			RU 0532-080	RU 0533-080
85			RU 0532-085	RU 0533-085
90			RU 0532-090	RU 0533-090
95			RU 0532-095	RU 0533-095
100			RU 0532-100	RU 0533-100
105			RU 0532-105	RU 0533-105
110			RU 0532-110	RU 0533-110
115			RU 0532-115	RU 0533-115
120			RU 0532-120	RU 0533-120





**Instrumente zum Einbringen von Hohlschrauben**  
**Instruments for Cannulated Screws**  
**Instrumental para tornillos de perforación longitudinal**  
**Instrumentation pour vis cannelées**  
**Strumentario per viti cannulate**



Corticalisfräser  
Cortex reamer  
Fresadoras corticales  
Fraises corticales  
Fresa da corticale



Ø  
4,5 mm **RU 0530-545**  
7,0 mm **RU 0530-570**

Eindrehschlüssel  
T-Handles, hexagonal key  
Destornilladores  
hexagonales  
Clés à écrous  
Chiave a T

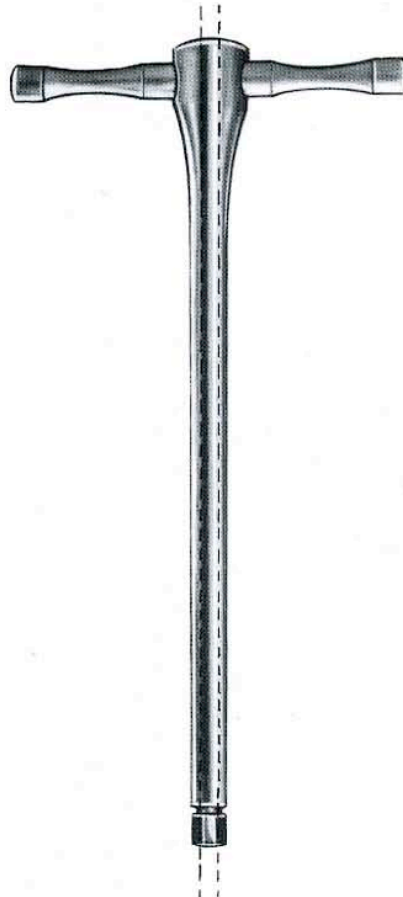

Ø  
3,5 mm **RU 0530-635**  
5,0 mm **RU 0530-650**



**Instrumente zum Einbringen von Hohlschrauben**  
**Instruments for Cannulated Screws**  
**Instrumental para tornillos de perforación longitudinal**  
**Instrumentation pour vis cannelées**  
**Strumentario per viti cannulate**



**Gewebeschutzhülse**  
**Tissue protector sleeve**  
**Vainas protectoras para tejido**  
**Gaine de protection du tissu**  
**Guaina protetti tessuti**



**RU 0530-720**



**Selbstspannende Knochenplatten mit Gleitlöchern**  
**Bone Plates with Spherical Gliding Holes**  
**Placas de compresión con orificios para deslizar**  
**Plaques autoserrantes avec trous de glissement**  
**Placche ad autocompressione con fori ovali**



schmale Platten  
narrow plates  
placas estrechas  
plaques étroites  
placche strette

Länge Length Largo longueur lunghezza	Lochzahl no. of holes Núm. de orificios quantité de trous no. di fori	
39 mm	2	RU 0600-039
55 mm	3	RU 0600-055
71 mm	4	RU 0600-071
87 mm	5	RU 0600-087
103 mm	6	RU 0600-103
119 mm	7	RU 0600-119
135 mm	8	RU 0600-135
151 mm	9	RU 0600-151
167 mm	10	RU 0600-167
183 mm	11	RU 0600-183
199 mm	12	RU 0600-199
215 mm	13	RU 0600-215
231 mm	14	RU 0600-231
247 mm	15	RU 0600-247
263 mm	16	RU 0600-263

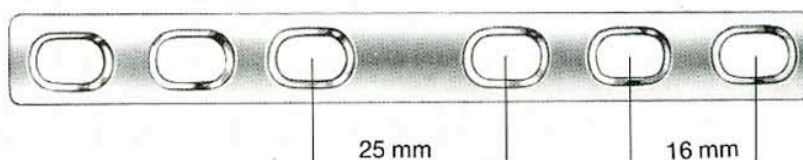
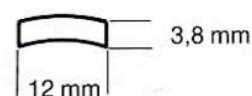



**Selbstspannende Knochenplatten mit Gleitlöchern**  
**Bone Plates with Spherical Gliding Holes**  
**Placas de compresión con orificios para deslizar**  
**Plaques autoserrantes avec trous de glissement**  
**Placche ad autocompressione con fori ovali**



breite Platten  
wide plates  
placas anchas  
plaques larges  
placche larghe

Länge length largo longueur lunghezza	Lochzahl no. of holes Núm. de orificios quantité de trous no. di fori	
103 mm	6	<b>RU 0601-103</b>
119 mm	7	<b>RU 0601-119</b>
135 mm	8	<b>RU 0601-135</b>
151 mm	9	<b>RU 0601-151</b>
167 mm	10	<b>RU 0601-167</b>
183 mm	11	<b>RU 0601-183</b>
199 mm	12	<b>RU 0601-199</b>
215 mm	13	<b>RU 0601-215</b>
231 mm	14	<b>RU 0601-231</b>
263 mm	16	<b>RU 0601-263</b>
295 mm	18	<b>RU 0601-295</b>

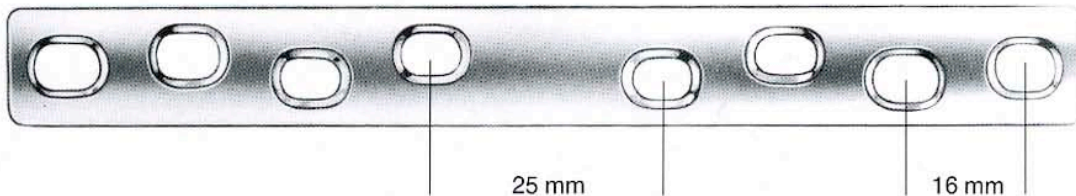
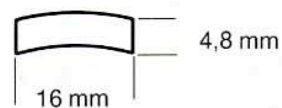





**Knochenplatten mit Rund- und Gleitlöchern**  
**Bone Plates with Round Holes**  
**Placas con orificios redondos y para deslizar**  
**Plaques avec trous ronds**  
**Placche con fori rotondi**



Länge length largo longueur lunghezza	Lochzahl no. of holes Núm. de orificios quantité de trous no. di fori	
39 mm	2	RU 0616-039
55 mm	3	RU 0616-055
71 mm	4	RU 0616-071
87 mm	5	RU 0616-087
103 mm	6	RU 0616-103
119 mm	7	RU 0616-119
135 mm	8	RU 0616-135
151 mm	9	RU 0616-151
167 mm	10	RU 0616-167
183 mm	11	RU 0616-183
199 mm	12	RU 0616-199



Halbrohrplatten  
 Semi-tubular plates  
 Placas semitubulares  
 Plaques semitubulaires  
 Placche semicerchio

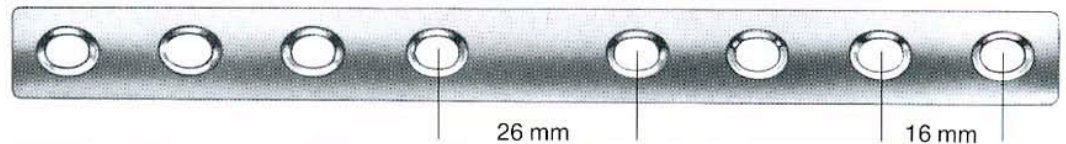

Länge length largo longueur lunghezza	Lochzahl no. of holes Núm. de orificios quantité de trous no. di fori	
25 mm	2	RU 0617-025
37 mm	3	RU 0617-037
49 mm	4	RU 0617-049
61 mm	5	RU 0617-061
73 mm	6	RU 0617-073
85 mm	7	RU 0617-085
97 mm	8	RU 0617-097

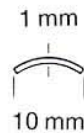

Drittelrohrplatten  
 One-third tubular plates  
 Placas de un tercio de tubo  
 Plaques d'un tiers de tube  
 Placche un terzo di cerchio

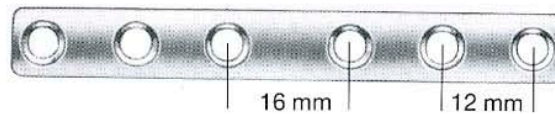

Länge length largo longueur lunghezza	Lochzahl no. of holes Núm. de orificios quantité de trous no. di fori	
23 mm	3	RU 0618-023
31 mm	4	RU 0618-031
39 mm	5	RU 0618-039
47 mm	6	RU 0618-047
55 mm	7	RU 0618-055
63 mm	8	RU 0618-063
71 mm	9	RU 0618-071



Viertelrohrplatten  
 Quarter-tubular plates  
 Placas de un cuarto de tubo  
 Plaques d'un quart de tube  
 Placche un quarto di cerchio

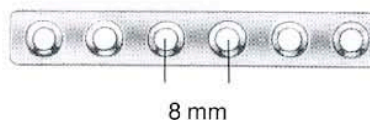



**Knochenplatten mit Rundlöchern**  
**Bone Plates with Round Holes**  
**Placas con orificios redondos**  
**Plaques avec trous ronds**  
**Placche con fori rotondi**



T-Platten  
 T-Plates  
 Placas en forma T  
 Plaques en forme T  
 Placche a T

Länge length largo longueur lunghezza	Lochzahl no. of holes Núm. de orificios quantité de trous no. di fori	
68 mm	3	<b>RU 0620-068</b>
84 mm	4	<b>RU 0620-084</b>
110 mm	5	<b>RU 0620-110</b>
116 mm	6	<b>RU 0620-116</b>
148 mm	8	<b>RU 0620-148</b>

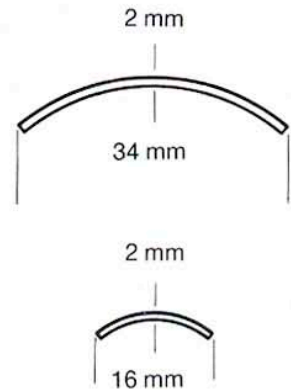
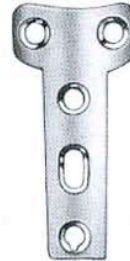

L-Platten  
 L-Plates  
 Placas en forma L  
 Plaques en forme L  
 Placche a L

links left a la izquierda à gauche sinistra	Lochzahl no. of holes Núm. de orificios quantité de trous no. di fori
<b>RU 0621-084</b>	4
<b>RU 0621-116</b>	6
<b>RU 0621-148</b>	8

Länge length largo longueur lunghezza	rechts right a la derecha à droite destra
84 mm	<b>RU 0622-084</b>
116 mm	<b>RU 0622-116</b>
148 mm	<b>RU 0622-148</b>

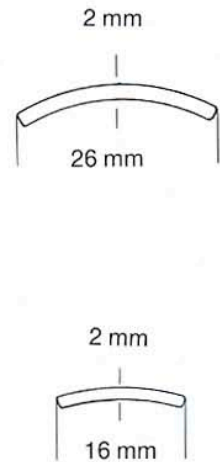

T-Abstützplatten  
 T-Buttress plates  
 Placas de sostén en forma T  
 Plaques de support en forme T  
 Placche di sostegno a T

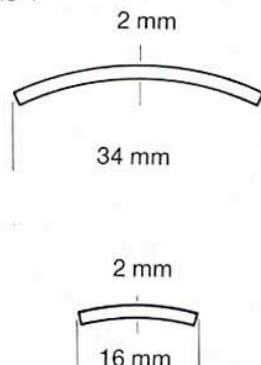
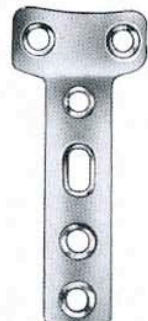

Länge length largo longueur lunghezza	Lochzahl no. of holes Núm. de orificios quantité de trous no. di fori	
80 mm	4	<b>RU 0623-080</b>
96 mm	5	<b>RU 0623-096</b>
112 mm	6	<b>RU 0623-112</b>

L-Abstützplatten  
 L-Buttress plates  
 Placas de sostén en forma L  
 Plaques de support en forme L  
 Placche di sostegno a L

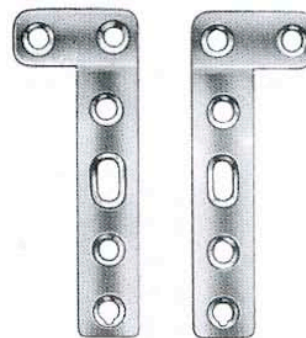

**RU 0624-001**    **RU 0624-002**

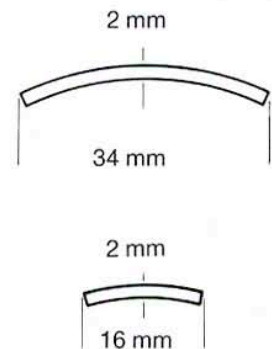



**Knochenplatten mit Rundlöchern**  
**Bone Plates with Round Holes**  
**Placas con orificios redondos**  
**Plaques avec trous ronds**  
**Placche con fori rotondi**



Löffelplatten  
 Spoon plates  
 Placas en forma de cuchara  
 Plaques en forme de cuillère  
 Placche a cucchiaio

Länge length largo longueur lunghezza	Lochzahl no. of holes Núm. de orificios quantité de trous no. di fori	
100 mm	5	<b>RU 0630-100</b>
120 mm	6	<b>RU 0630-120</b>

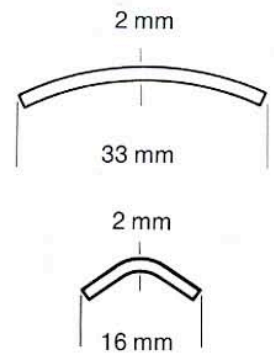

Kleeblatt-Platten  
 Cloverleaf plates  
 Placas entrébol  
 Plaques en forme de trèfle  
 Placche in forma di trifoglio

Länge length largo longueur lunghezza	Lochzahl no. of holes Núm. de orificios quantité de trous no. di fori	
88 mm	3	<b>RU 0632-088</b>
104 mm	4	<b>RU 0632-104</b>

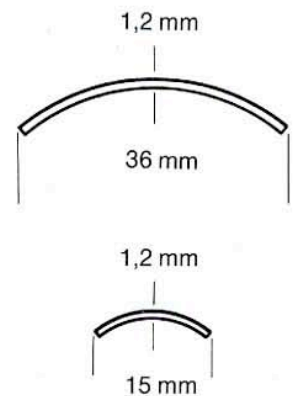
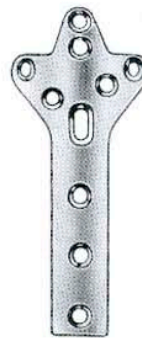





**Klein-Fragmentplatten mit Gleitlöchern**  
**Small Fragment Plates with Spherical Gliding Holes**  
**Placas para pequeños fragmentos con orificios para deslizar**  
**Plaques pour petits fragments avec trous de glissement**  
**Piccole placche per frammenti con fori ovali**



Länge length largo longueur lunghezza	Lochzahl no. of holes Núm. de orificios quantité de trous no. di fori	
25 mm	2	<b>RU 0650-025</b>
37 mm	3	<b>RU 0650-037</b>
49 mm	4	<b>RU 0650-049</b>
61 mm	5	<b>RU 0650-061</b>
73 mm	6	<b>RU 0650-073</b>
85 mm	7	<b>RU 0650-085</b>
97 mm	8	<b>RU 0650-097</b>
121 mm	10	<b>RU 0650-121</b>
145 mm	12	<b>RU 0650-145</b>

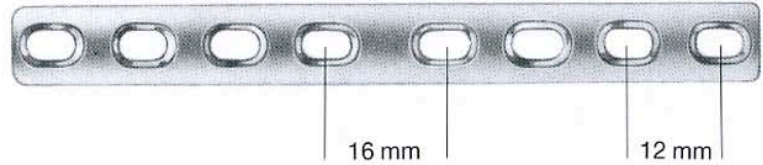
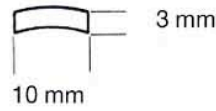

Länge length largo longueur lunghezza	Lochzahl no. of holes Núm. de orificios quantité de trous no. di fori	
20 mm	2	<b>RU 0651-020</b>
36 mm	4	<b>RU 0651-036</b>
44 mm	5	<b>RU 0651-044</b>
52 mm	6	<b>RU 0651-052</b>
60 mm	7	<b>RU 0651-060</b>
68 mm	8	<b>RU 0651-068</b>
76 mm	9	<b>RU 0651-076</b>
84 mm	10	<b>RU 0651-084</b>
100 mm	12	<b>RU 0651-100</b>

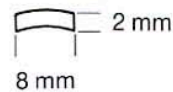

**Mini-Platten**  
**Mini-plates**  
**Mini-placas**  
**Mini-plaques**  
**Mini placche**

Länge length largo longueur lunghezza	Lochzahl no. of holes Núm. de orificios quantité de trous no. di fori	
17 mm	3	<b>RU 0653-017</b>
23 mm	4	<b>RU 0653-023</b>
29 mm	5	<b>RU 0653-029</b>
35 mm	6	<b>RU 0653-035</b>





**Klein-Fragmentplatten mit Rundlöchern**  
**Small Fragment Plates with Round Holes**  
**Placas para pequeños fragmentos con orificios redondos**  
**Plaques pour petits fragments avec trous de glissement**  
**Piccole placche per frammenti con fori ovali**



T-Platten  
T-Plates  
Placas en forma T  
Plaques en forme T  
Placche a T

10 × 1 mm



Länge length largo longueur lunghezza	Lochzahl no. of holes Núm. de orificios quantité de trous no. di fori	
39 mm	3 × 3	<b>RU 0658-039</b>
67 mm	3 × 5	<b>RU 0658-067</b>
56 mm	4 × 4	<b>RU 0658-056</b>
78 mm	4 × 6	<b>RU 0658-078</b>

T-Platten  
T-Plates  
Placas en forma T  
Plaques en forme T  
Placche a T

schiefwinklig  
oblique angle  
angulo oblicuo  
angle oblique  
angolo oblico



39 mm  
**RU 0659-039**

67 mm  
**RU 0659-067**



**Klein-Fragmentplatten mit Rundlöchern**  
**Small Fragment Plates with Round Holes**  
**Placas para pequeños fragmentos con orificios redondos**  
**Plaques pour petits fragments avec trous de glissement**  
**Piccole placche per frammenti con fori ovali**



L-Platten  
 L-Plates  
 Placas en forma L  
 Plaques en forme L  
 Placche a L

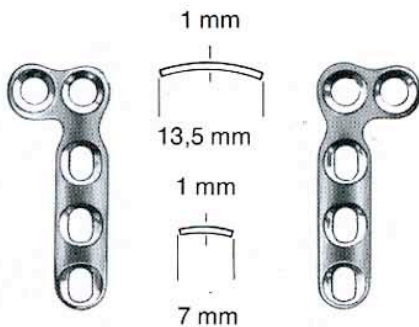

**RU 0660-021**

**RU 0660-022**

links  
 left  
 a la izquierda  
 à gauche  
 sinistra

rechts  
 right  
 a la derecha  
 à droite  
 destra

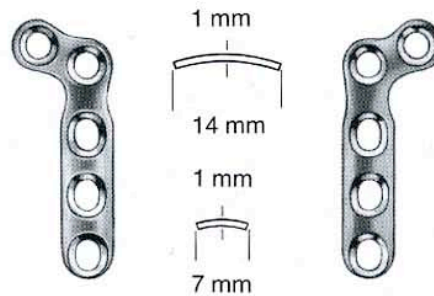

**RU 0660-023**

**RU 0660-024**

schräg links  
 oblique left  
 a la izquierda, oblicua  
 à gauche, oblique  
 sinistra obliche

schräg rechts  
 oblique right  
 a la derecha, oblicua  
 à droite, oblique  
 destra obliche

T-Platte  
 T-Plate  
 Placas en forma T  
 Plaques en forme T  
 Placche a T

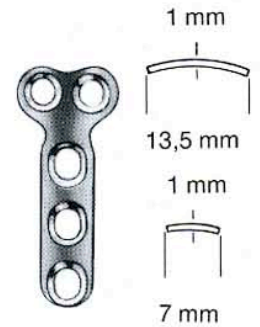

**RU 0660-025**

Gerade Mini-Platten  
 Straight mini plates  
 Mini-placas rectas  
 Mini-plaques, droites  
 mini placche rette



**RU 0661-021**

**RU 0661-022**

links  
 left  
 a la izquierda  
 à gauche  
 sinistra

rechts  
 right  
 a la derecha  
 à droite  
 destra



**RU 0661-023**

**RU 0661-024**

schräg links  
 oblique left  
 a la izquierda, oblicua  
 à gauche, oblique  
 sinistra obliche

schräg rechts  
 oblique right  
 a la derecha, oblicua  
 à droite, oblique  
 destra obliche

T-Platte  
 T-Plate  
 Placas en forma T  
 Plaque en forme T  
 Placche a T

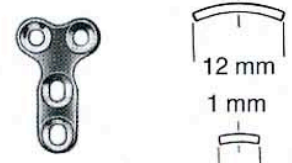

**RU 0661-025**





**Selbstspannende Winkelplatten mit Gleitlöchern**  
**Angular Bone Plates with Spherical Gliding Holes**  
**Placas anguladas de autocompresión con orificios para deslizar**  
**Plaques angulaires autoserrantes avec trous de glissement**  
**Placche angolate ad autocompressione con fori ovali**



Winkelplatten für pertrochantere Frakturen  
 Angled blade plates for pertrochantric fractures  
 Placas anguladas para fracturas pertrocantéreas  
 Plaques angulaires pour fractures pertrocantères  
 Placche angolati per fratture pertrocantiche

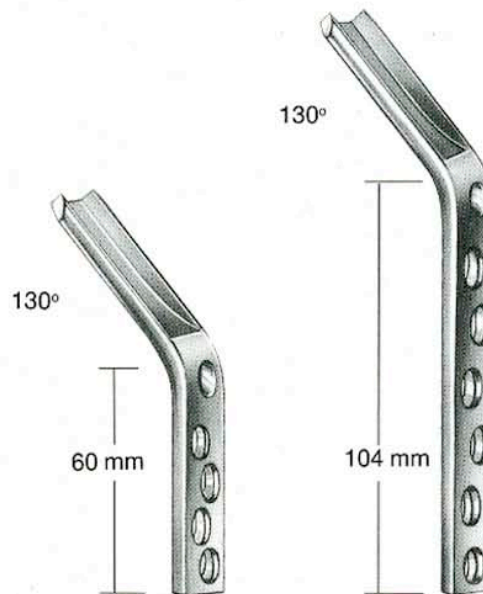
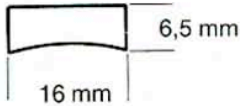
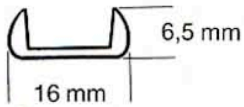

Klingenlängen lengths of blades largo de hojas longueurs des lames lunghezza delle lame	Plattenlängen lengths of plates largo de placas longueurs des plaques lunghezza delle placche	
	60 mm 4 Löcher/holes/orificios trous/fori	104 mm 6 Löcher/holes/orificios trous/fori
50 mm	<b>RU 0671-050</b>	<b>RU 0672-050</b>
60 mm	<b>RU 0671-060</b>	<b>RU 0672-060</b>
70 mm	<b>RU 0671-070</b>	<b>RU 0672-070</b>
75 mm	<b>RU 0671-075</b>	
80 mm	<b>RU 0671-080</b>	<b>RU 0672-080</b>
85 mm	<b>RU 0671-085</b>	
90 mm	<b>RU 0671-090</b>	<b>RU 0672-090</b>
95 mm	<b>RU 0671-095</b>	
100 mm	<b>RU 0671-100</b>	
105 mm	<b>RU 0671-105</b>	
110 mm	<b>RU 0671-110</b>	



**Selbstspannende Winkelplatten mit Gleitlöchern**  
**Angular Bone Plates with Spherical Gliding Holes**  
**Placas anguladas de autocompresión con orificios para deslizar**  
**Plaques angulaires autoserrantes avec trous de glissement**  
**Placche angolate ad autocompressione con fori ovali**



Winkelplatten für pertrochantere Frakturen  
 Angled blade plates for pertrochantric fractures  
 Placas anguladas para fracturas pertrocantéreas  
 Plaques angulaires pour fractures pertrocantères  
 Placche angolati per fratture pertrocanteree

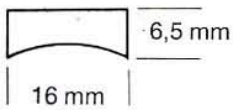
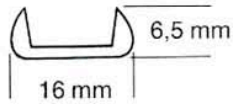

Klingenlängen lengths of blades largo de hojas longueurs des lames lunghezze delle lame	Plattenlängen lengths of plates largo de placas longueurs des plaques lunghezze delle placche	
	152 mm 9 Löcher/holes/orificios trous/fori	200 mm 12 Löcher/holes/orificios trous/fori
70 mm	<b>RU 0673-070</b>	<b>RU 0674-070</b>
80 mm	<b>RU 0673-080</b>	<b>RU 0674-080</b>
90 mm	<b>RU 0673-090</b>	<b>RU 0674-090</b>



**Winkelplatten**  
**Angled Blade Plates**  
**Placas anguladas**  
**Plaques angulaires**  
**Placche angolate**



Kondylenplatten  
 Condylar Plates  
 Placas condileas  
 Plaques condylaires  
 Placche condiliche

Klingenlänge  
 length of blade  
 largo de hoja  
 longueur de lame  
 lunghezza della lama

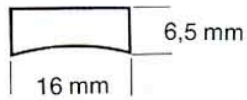
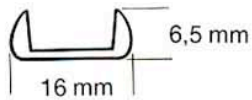

mit Gleitlöchern  
 with spherical gliding holes  
 con orificios para deslizar  
 avec trous à glissement  
 con fori ovali

Klingenlängen  
 lengths of blades  
 largo de hojas  
 longueurs de lames  
 lunghezze delle lame

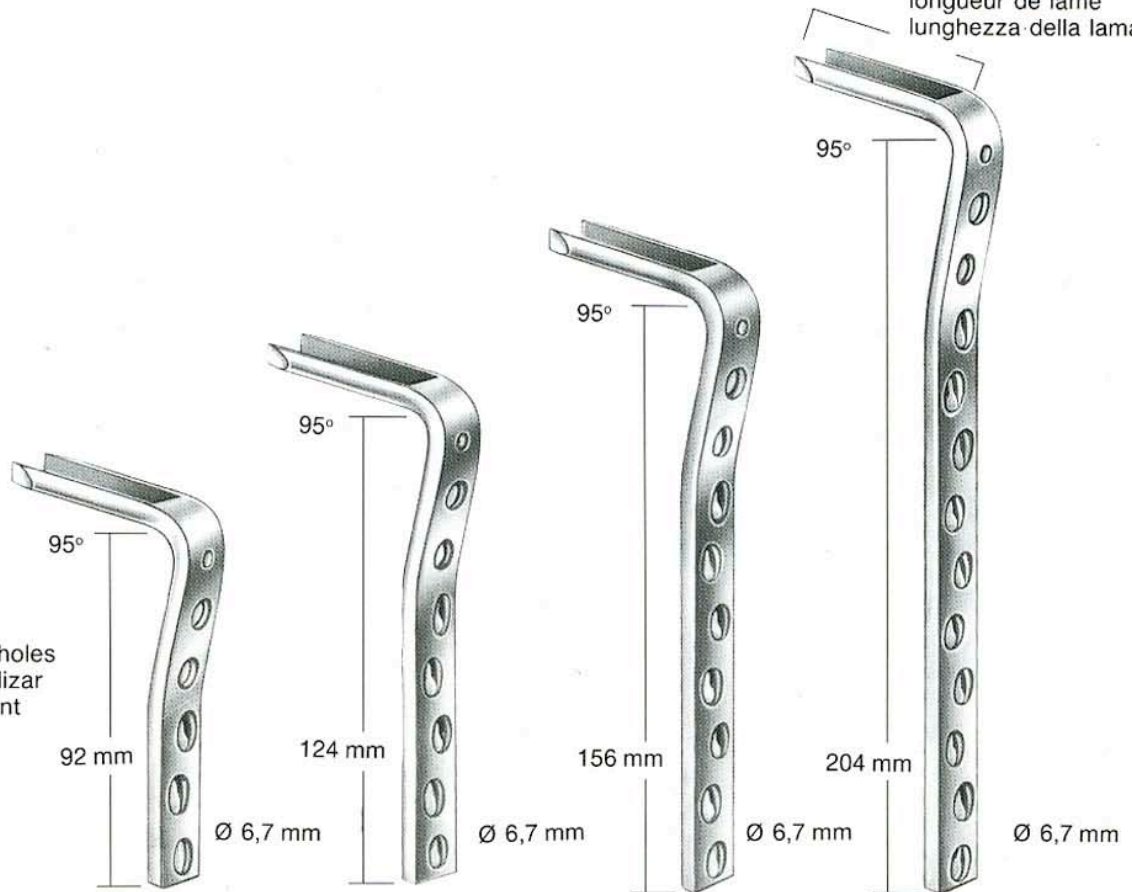

	92 mm 5 Löcher/holes/orificios trous/fori	124 mm 7 Löcher/holes/orificios trous/fori	156 mm 9 Löcher/holes/orificios trous/fori	204 mm 12 Löcher/holes/orificios trous/fori
50 mm	<b>RU 0680-150</b>	<b>RU 0680-250</b>	<b>RU 0680-350</b>	<b>RU 0680-450</b>
60 mm	<b>RU 0680-160</b>	<b>RU 0680-260</b>	<b>RU 0680-360</b>	<b>RU 0680-460</b>
70 mm	<b>RU 0680-170</b>	<b>RU 0680-270</b>	<b>RU 0680-370</b>	<b>RU 0680-470</b>
80 mm	<b>RU 0680-180</b>	<b>RU 0680-280</b>	<b>RU 0680-380</b>	<b>RU 0680-480</b>

mit Rundlöchern  
 with round holes  
 con orificios redondos  
 avec trous ronds  
 con fori rotondi

Klingenlängen  
 lengths of blades  
 largo de hojas  
 longueurs de lames  
 lunghezze delle lame

	92 mm 5 Löcher/holes/orificios trous/fori	124 mm 7 Löcher/holes/orificios trous/fori	156 mm 9 Löcher/holes/orificios trous/fori	204 mm 12 Löcher/holes/orificios trous/fori
50 mm	<b>RU 0681-150</b>	<b>RU 0681-250</b>	<b>RU 0681-350</b>	<b>RU 0681-450</b>
60 mm	<b>RU 0681-160</b>	<b>RU 0681-260</b>	<b>RU 0681-360</b>	<b>RU 0681-460</b>
70 mm	<b>RU 0681-170</b>	<b>RU 0681-270</b>	<b>RU 0681-370</b>	<b>RU 0681-470</b>
80 mm	<b>RU 0681-180</b>	<b>RU 0681-280</b>	<b>RU 0681-380</b>	<b>RU 0681-480</b>





**Winkelplatten**  
**Angled Blade Plates**  
**Placas anguladas**  
**Plaques angulaires**  
**Placche angolate**



Winkelplatten für intertrochanterere Femur-Osteotomie bei Erwachsenen  
 Angled blade plates for intertrochanteric femoral osteotomy of adults  
 Placas anguladas para osteotomías intertrocantéreas del fémur en adultos  
 Plaques angulaires pour l'ostéotomie intertrocartaire de fémur chez adultes  
 Placche angolate introcantenee femore-osterotomia per adulti

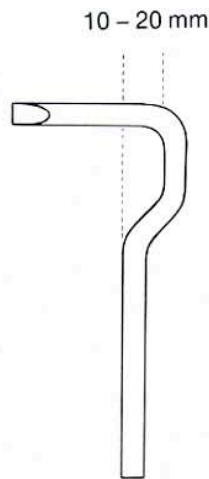
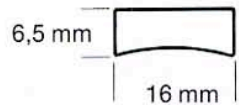
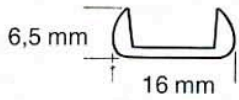

Fig. 1

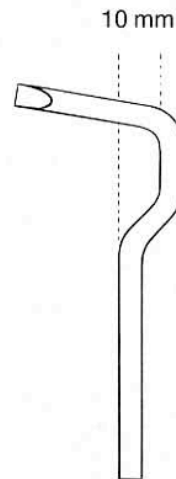
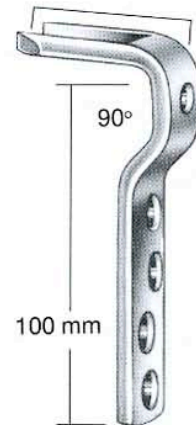

Fig. 2

Klingenlänge  
 length of blade  
 largo de la hoja  
 longueur de lame  
 lunghezza della lama



mit Gleitlöchern  
 with spherical gliding holes  
 con orificios para deslizar  
 avec trous à glissement  
 con fori ovali

Klingenlängen lengths of blades largo de hojas longueurs de lames lunghezze delle lame	Bogentiefe displacement profundidad del arco profondeur de l'arc profondità dell'arco	
	Fig. 1 90°	Fig. 2 100°
40 mm	<b>RU 0683-004</b>	10 mm
50 mm	<b>RU 0683-005</b>	15 mm
60 mm	<b>RU 0683-006</b>	15 mm
60 mm	<b>RU 0683-016</b>	20 mm
60 mm	<b>RU 0683-026</b>	

mit Rundlöchern  
 with round holes  
 con orificios redondos  
 avec trous ronds  
 con fori rotondi

Klingenlängen lengths of blades largo de hojas longueurs de lames lunghezze delle lame	Bogentiefe displacement profundidad del arco profondeur de l'arc profondità dell'arco	
	Fig. 1 90°	Fig. 2 100°
40 mm	<b>RU 0684-004</b>	10 mm
50 mm	<b>RU 0684-005</b>	15 mm
60 mm	<b>RU 0684-006</b>	15 mm
60 mm	<b>RU 0684-016</b>	20 mm
60 mm	<b>RU 0684-026</b>	



Schraubendreher  
Screw Drivers  
Destornilladores  
Tourne-vis  
Cacciaviti



mit Ferrozellgriff  
with Ferrozell handle  
con mango de Ferrozell  
avec poignée en Ferrozell  
con manico di Ferrozell

2,5 mm    3,5 mm

Länge  
length  
largo  
longueur  
lunghezza

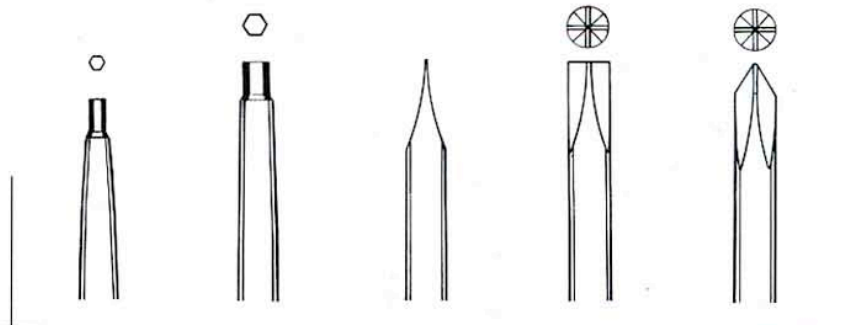

17 cm/6 <sup>3</sup> / <sub>4</sub> "			RU 0700-417		
20 cm/8"	RU 0700-220	RU 0700-320			RU 0700-620
25 cm/10"	RU 0700-225	RU 0700-325	RU 0700-425	RU 0700-525	RU 0700-625



3,5 mm

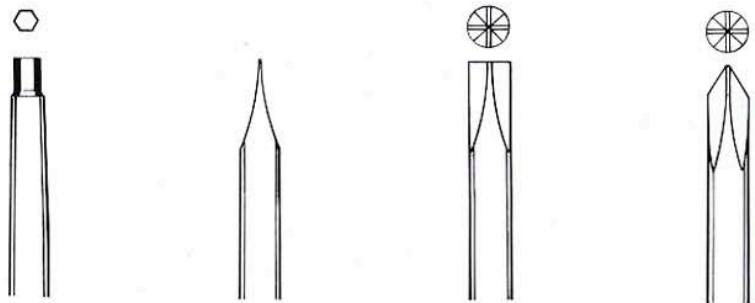

RU 0701-001    RU 0701-002    RU 0701-003    RU 0701-004

Williams  
24 cm/9<sup>1</sup>/<sub>2</sub>"







**Küntscher Nägel für Oberschenkel**  
**Küntscher Intramedullary Nails**  
**Küntscher Clavos Intramedulares**  
**Küntscher clous pour fémur**  
**Chiodi di Küntscher per femore**



mit 1 Öse · with 1 eye · con 1 oja · avec 1 oeillet · con 1 foro



Länge length largo cm	longueur lunghezza in	Ø	Ø	Ø	Ø	Ø	Ø	Ø	Ø	Ø	Ø	Ø
		6 mm Fig. 1	7 mm Fig. 2	8 mm Fig. 3	9 mm Fig. 4	10 mm Fig. 5	11 mm Fig. 6	12 mm Fig. 7	13 mm Fig. 8	14 mm Fig. 9	15 mm Fig. 10	16 mm Fig. 11
18	7	RU 0800-118	RU 0800-218									
20	8	RU 0800-120	RU 0800-220									
22	8 <sup>3</sup> / <sub>4</sub>	RU 0800-122	RU 0800-222									
24	9 <sup>1</sup> / <sub>2</sub>	RU 0800-124	RU 0800-224	RU 0800-324								
26	10 <sup>1</sup> / <sub>4</sub>	RU 0800-126	RU 0800-226	RU 0800-326								
28	11	RU 0800-128	RU 0800-228	RU 0800-328								
30	12	RU 0800-130	RU 0800-230	RU 0800-330	RU 0800-430		RU 0800-630					
32	12 <sup>1</sup> / <sub>2</sub>	RU 0800-132	RU 0800-232	RU 0800-332	RU 0800-432	RU 0800-532	RU 0800-632					
34	13 <sup>1</sup> / <sub>2</sub>	RU 0800-134	RU 0800-234	RU 0800-334	RU 0800-434	RU 0800-534	RU 0800-634	RU 0800-734	RU 0800-834	RU 0800-934		
36	14		RU 0800-236	RU 0800-336	RU 0800-436	RU 0800-536	RU 0800-636	RU 0800-736	RU 0800-836	RU 0800-936	RU 0801-036	RU 0801-136
38	15		RU 0800-238	RU 0800-338	RU 0800-438	RU 0800-538	RU 0800-638	RU 0800-738	RU 0800-838	RU 0800-938	RU 0801-038	RU 0801-138
40	15 <sup>3</sup> / <sub>4</sub>		RU 0800-240	RU 0800-340	RU 0800-440	RU 0800-540	RU 0800-640	RU 0800-740	RU 0800-840	RU 0800-940	RU 0801-040	RU 0801-140
42	16 <sup>1</sup> / <sub>2</sub>			RU 0800-342	RU 0800-442	RU 0800-542	RU 0800-642	RU 0800-742	RU 0800-842	RU 0800-942	RU 0801-042	RU 0801-142
44	17 <sup>1</sup> / <sub>4</sub>			RU 0800-344	RU 0800-444	RU 0800-544	RU 0800-644	RU 0800-744	RU 0800-844	RU 0800-944	RU 0801-044	RU 0801-144
46	18			RU 0800-346	RU 0800-446	RU 0800-546	RU 0800-646	RU 0800-746	RU 0800-846	RU 0800-946	RU 0801-046	RU 0801-146
48	19			RU 0800-348	RU 0800-448	RU 0800-548	RU 0800-648	RU 0800-748	RU 0800-848	RU 0800-948	RU 0801-048	RU 0801-148
50	19 <sup>3</sup> / <sub>4</sub>			RU 0800-350	RU 0800-450	RU 0800-550	RU 0800-650	RU 0800-750	RU 0800-850	RU 0800-950	RU 0801-050	RU 0801-150
52	20 <sup>1</sup> / <sub>2</sub>				RU 0800-452	RU 0800-552	RU 0800-652	RU 0800-752	RU 0800-852	RU 0800-952	RU 0801-052	RU 0801-152

mit 2 Ösen · with 2 eyes · con 2 ojas · · avec 2 oeillets · con 2 fori



Länge length largo cm	longueur lunghezza in	Ø	Ø	Ø	Ø	Ø	Ø	Ø	Ø	Ø	Ø	Ø
		6 mm Fig. 1	7 mm Fig. 2	8 mm Fig. 3	9 mm Fig. 4	10 mm Fig. 5	11 mm Fig. 6	12 mm Fig. 7	13 mm Fig. 8	14 mm Fig. 9	15 mm Fig. 10	16 mm Fig. 11
18	7	RU 0802-118	RU 0802-218									
20	8	RU 0802-120	RU 0802-220									
22	8 <sup>3</sup> / <sub>4</sub>	RU 0802-122	RU 0802-222									
24	9 <sup>1</sup> / <sub>2</sub>	RU 0802-124	RU 0802-224	RU 0802-324								
26	10 <sup>1</sup> / <sub>4</sub>	RU 0802-126	RU 0802-226	RU 0802-326								
28	11	RU 0802-128	RU 0802-228	RU 0802-328								
30	12	RU 0802-130	RU 0802-230	RU 0802-330	RU 0802-430							
32	12 <sup>1</sup> / <sub>2</sub>	RU 0802-132	RU 0802-232	RU 0802-332	RU 0802-432	RU 0802-532	RU 0802-632					
34	13 <sup>1</sup> / <sub>2</sub>	RU 0802-134	RU 0802-234	RU 0802-334	RU 0802-434	RU 0802-534	RU 0802-634	RU 0802-734	RU 0802-834	RU 0802-934		
36	14		RU 0802-236	RU 0802-336	RU 0802-436	RU 0802-536	RU 0802-636	RU 0802-736	RU 0802-836	RU 0802-936	RU 0803-036	RU 0803-136
38	15		RU 0802-238	RU 0802-338	RU 0802-438	RU 0802-538	RU 0802-638	RU 0802-738	RU 0802-838	RU 0802-938	RU 0803-038	RU 0803-138
40	15 <sup>3</sup> / <sub>4</sub>		RU 0802-240	RU 0802-340	RU 0802-440	RU 0802-540	RU 0802-640	RU 0802-740	RU 0802-840	RU 0802-940	RU 0803-040	RU 0803-140
42	16 <sup>1</sup> / <sub>2</sub>			RU 0802-342	RU 0802-442	RU 0802-542	RU 0802-642	RU 0802-742	RU 0802-842	RU 0802-942	RU 0803-042	RU 0803-142
44	17 <sup>1</sup> / <sub>4</sub>			RU 0802-344	RU 0802-444	RU 0802-544	RU 0802-644	RU 0802-744	RU 0802-844	RU 0802-944	RU 0803-044	RU 0803-144
46	18			RU 0802-346	RU 0802-446	RU 0802-546	RU 0802-646	RU 0802-746	RU 0802-846	RU 0802-946	RU 0803-046	RU 0803-146
48	19			RU 0802-348	RU 0802-448	RU 0802-548	RU 0802-648	RU 0802-748	RU 0802-848	RU 0802-948	RU 0803-048	RU 0803-148
50	19 <sup>3</sup> / <sub>4</sub>			RU 0802-350	RU 0802-450	RU 0802-550	RU 0802-650	RU 0802-750	RU 0802-850	RU 0802-950	RU 0803-050	RU 0803-150
52	20 <sup>1</sup> / <sub>2</sub>				RU 0802-452	RU 0802-552	RU 0802-652	RU 0802-752	RU 0802-852	RU 0802-952	RU 0803-052	RU 0803-152





**Küntscher Nägel für Oberschenkel und Oberarm**  
**Küntscher Intramedullary Nails**  
**Küntscher Clavos Intramedulares**  
**Küntscher clous pour fémur**  
**Chiodi di Küntscher per femore ed omero**



Länge length largo	longueur lunghezza	Ø	Ø	Ø	Ø	Ø	Ø	Ø	Ø	Ø
		6 mm	7 mm	8 mm	9 mm	10 mm	11 mm	12 mm	13 mm	14 mm
cm	in	Fig. 1	Fig. 2	Fig. 3	Fig. 4	Fig. 5	Fig. 6	Fig. 7	Fig. 8	Fig. 9
18	7	RU 0804-118	RU 0804-218	RU 0804-318	RU 0804-418	RU 0804-518	RU 0804-618			
19	7 <sup>1</sup> / <sub>2</sub>		RU 0804-219	RU 0804-319	RU 0804-419	RU 0804-519	RU 0804-619			
20	8	RU 0804-120	RU 0804-220	RU 0804-320	RU 0804-420	RU 0804-520	RU 0804-620			
21	8 <sup>1</sup> / <sub>4</sub>		RU 0804-221	RU 0804-321	RU 0804-421	RU 0804-521	RU 0804-621			
22	10 <sup>1</sup> / <sub>2</sub>	RU 0804-122	RU 0804-222	RU 0804-322	RU 0804-422	RU 0804-522	RU 0804-622			
23	9		RU 0804-223	RU 0804-323	RU 0804-423	RU 0804-523	RU 0804-623			
24	9 <sup>1</sup> / <sub>2</sub>	RU 0804-124	RU 0804-224	RU 0804-324	RU 0804-424	RU 0804-524	RU 0804-624	RU 0804-724		
25	10		RU 0804-225	RU 0804-325	RU 0804-425	RU 0804-525	RU 0804-625	RU 0804-725		
26	10 <sup>1</sup> / <sub>4</sub>	RU 0804-126	RU 0804-226	RU 0804-326	RU 0804-426	RU 0804-526	RU 0804-626	RU 0804-726		
27	10 <sup>3</sup> / <sub>4</sub>		RU 0804-227	RU 0804-327	RU 0804-427	RU 0804-527	RU 0804-627	RU 0804-727	RU 0804-827	
28	11	RU 0804-128	RU 0804-228	RU 0804-328	RU 0804-428	RU 0804-528	RU 0804-628	RU 0804-728	RU 0804-828	
29	11 <sup>1</sup> / <sub>2</sub>		RU 0804-229	RU 0804-329	RU 0804-429	RU 0804-529	RU 0804-629	RU 0804-729	RU 0804-829	
30	12	RU 0804-130	RU 0804-230	RU 0804-330	RU 0804-430	RU 0804-530	RU 0804-630	RU 0804-730	RU 0804-830	RU 0804-930
31	12 <sup>1</sup> / <sub>4</sub>		RU 0804-231	RU 0804-331	RU 0804-431	RU 0804-531	RU 0804-631	RU 0804-731	RU 0804-831	RU 0804-931
32	12 <sup>1</sup> / <sub>2</sub>		RU 0804-232	RU 0804-332	RU 0804-432	RU 0804-532	RU 0804-632	RU 0804-732	RU 0804-832	RU 0804-932
33	13		RU 0804-233	RU 0804-333	RU 0804-433	RU 0804-533	RU 0804-633	RU 0804-733	RU 0804-833	RU 0804-933
34	13 <sup>1</sup> / <sub>2</sub>		RU 0804-234	RU 0804-334	RU 0804-434	RU 0804-534	RU 0804-634	RU 0804-734	RU 0804-834	RU 0804-934
35	13 <sup>3</sup> / <sub>4</sub>		RU 0804-235	RU 0804-335	RU 0804-435	RU 0804-535	RU 0804-635	RU 0804-735	RU 0804-835	RU 0804-935
36	14		RU 0804-236	RU 0804-336	RU 0804-436	RU 0804-536	RU 0804-636	RU 0804-736	RU 0804-836	RU 0804-936
37	14 <sup>1</sup> / <sub>2</sub>		RU 0804-237	RU 0804-337	RU 0804-437	RU 0804-537	RU 0804-637	RU 0804-737	RU 0804-837	RU 0804-937
38	15		RU 0804-238	RU 0804-338	RU 0804-438	RU 0804-538	RU 0804-638	RU 0804-738	RU 0804-838	RU 0804-938
39	15 <sup>1</sup> / <sub>2</sub>		RU 0804-239	RU 0804-339	RU 0804-439	RU 0804-539	RU 0804-639	RU 0804-739	RU 0804-839	RU 0804-939
40	15 <sup>3</sup> / <sub>4</sub>		RU 0804-240	RU 0804-340	RU 0804-440	RU 0804-540	RU 0804-640	RU 0804-740	RU 0804-840	RU 0804-940



**Instrumentarium für Küntscher Nägel**  
**Instruments for Küntscher Nails**  
**Instrumentos para Clavos Küntscher**  
**Instruments pour clous de Küntscher**  
**Strumentario per chiodi di Küntscher**



Vorbohrer zum Öffnen der Markhöhle  
 Reamers for medullary cave  
 Perforadores para la cavidad medúlar  
 Trépans pour l'ouverture de la cavité à moelle  
 Alesatore per l'apertura del midollo

Aufreiber für Oberschenkel  
 Reamer for femur  
 Perforador para fémur  
 Dilatateur pour fémur  
 Alesatore per femore

8 mm  
**RU 0806-008**

10 mm  
**RU 0806-010**



**Küntscher**



**Küntscher**  
**RU 0806-135**

Führungsspieße  
 Guide pins  
 Guía-conductoras para clavos medulares  
 Pointe-guides  
 Guida



für Nägel mit  
 for nails with  
 para clavos de  
 pour clous de  
 per chiodi con

3,0 mm Ø **RU 0806-230**  
 3,5 mm Ø **RU 0806-235**  
 4,0 mm Ø **RU 0806-240**  
 5,0 mm Ø **RU 0806-250**

8 mm Ø  
 9 mm Ø  
 10 – 11 mm Ø  
 12 – 13 mm Ø





**Instrumentarium für Küntscher Nägel**  
**Instruments for Küntscher Nails**  
**Instrumentos para Clavos Küntscher**  
**Instruments pour clous de Küntscher**  
**Strumentario per chiodi di Küntscher**



Schlitzhammer  
Slotted hammer  
Martillo con ranura  
Marteau avec fente  
Martello con fessura

Vorschläger  
Nail driver  
Impactor  
Impacteur  
Impattatore

Fertigschläger  
Nail impactors  
Impactor final  
Impacteurs finaux  
Impattatore finale



29 cm/11<sup>1</sup>/<sub>2</sub>"  
RU 0806-300



20 cm/8"  
RU 0806-400



für Nägel  
for nails  
para clavos  
pour clous  
per chiodi

6- 8 mm Ø  
RU 0806-501

9-12 mm Ø  
RU 0806-502

12-17 mm Ø  
RU 0806-503

19 cm/7<sup>1</sup>/<sub>2</sub>"



**Instrumentarium für Küntscher Nägel**  
**Instruments for Küntscher Nails**  
**Instrumentos para Clavos Küntscher**  
**Instrumentos pour clous de Küntscher**  
**Strumentario per chiodi di Küntscher**



Markraumbohrer  
Intramedullary drills  
Perforadores medulares  
Trépans médullaires  
Punte intramidollare

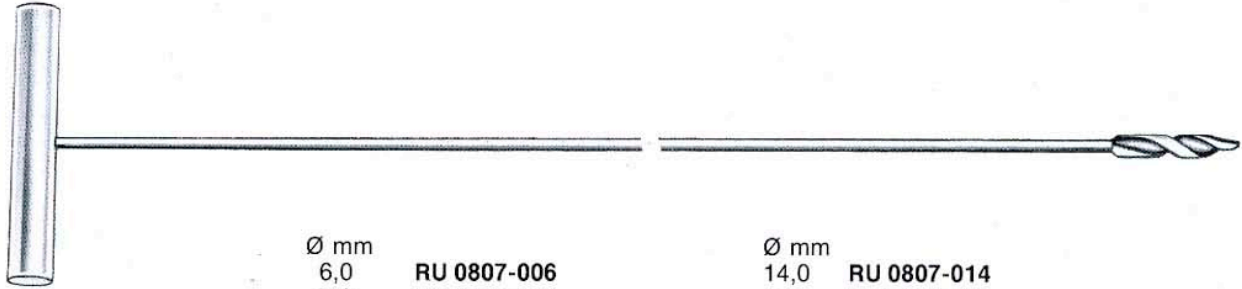

Ø mm		Ø mm	
6,0	RU 0807-006	14,0	RU 0807-014
7,0	RU 0807-007	15,0	RU 0807-015
8,0	RU 0807-008	16,0	RU 0807-016
9,0	RU 0807-009	17,0	RU 0807-017
10,0	RU 0807-010	18,0	RU 0807-018
11,0	RU 0807-011	19,0	RU 0807-019
12,0	RU 0807-012	20,0	RU 0807-020
13,0	RU 0807-013		

Extraktionshaken  
Extraction hooks  
Ganchos extractores  
Crochets d'extraction  
Gancio d'estrazione

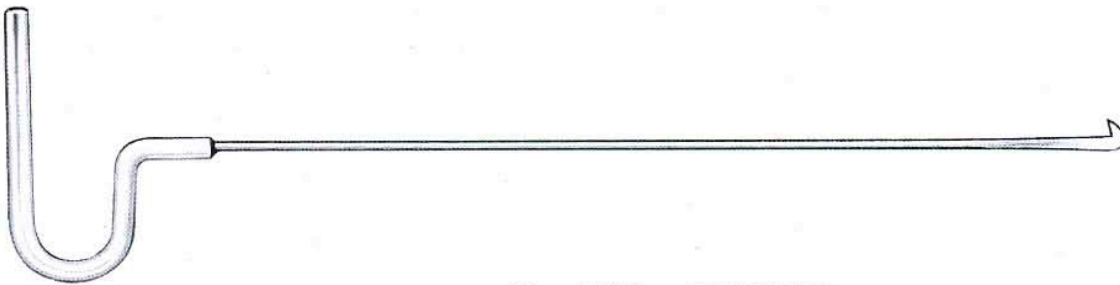

29 cm/11½"	RU 0808-029
37 cm/14½"	RU 0808-037
43 cm/17"	RU 0808-043
51 cm/20"	RU 0808-051

Extraktor mit 2 Haken  
Nail extractor with 2 hooks  
Aparato extractor con 2 ganchos  
Extracteur avec 2 crochets  
Estrattore con 2 ganci

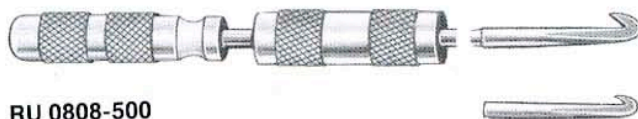

RU 0808-500

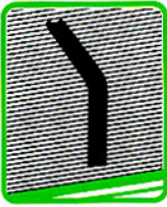

**Marknägel rund, mit Haken**  
**Intramedullary Pins, round, with hook**  
**Clavos intramedulares, redondos, con ganchos**  
**Clous médullaires, ronds, avec crochet**  
**Chiodi intramidollari, rotondi, con gancio**



Länge length largo mm	longueur lunghezza	2,4 mm Ø	3,2 mm Ø	4,8 mm Ø	6,4 mm Ø
25		RU 0810-025			
30		RU 0810-030			
40		RU 0810-040			
45		RU 0810-045			
50		RU 0810-050			
60		RU 0810-060			
65		RU 0810-065			
70		RU 0810-070			
75		RU 0810-075			
85		RU 0810-085			
90		RU 0810-090			
95		RU 0810-095			
100		RU 0810-100	RU 0811-100		
115		RU 0810-115	RU 0811-115		
125		RU 0810-125	RU 0811-125		
140		RU 0810-140	RU 0811-140		
150		RU 0810-150	RU 0811-150		
165		RU 0810-165	RU 0811-165		
180		RU 0810-180	RU 0811-180		
190		RU 0810-190	RU 0811-190		
205		RU 0810-205	RU 0811-205	RU 0812-205	
215		RU 0810-215	RU 0811-215		
220				RU 0812-220	
235			RU 0811-235		
240		RU 0810-240	RU 0811-240	RU 0812-240	
250					
255		RU 0810-255	RU 0811-255	RU 0812-255	
280				RU 0812-280	RU 0813-280
295				RU 0812-295	RU 0813-295
300					
315				RU 0812-315	RU 0813-315
335				RU 0812-335	RU 0813-335
355				RU 0812-355	RU 0813-355
375					RU 0813-375
395					RU 0813-395
410					RU 0813-410
430					RU 0813-430
Satz mit Halter set with rack juego con soporte jeu avec porte-clous set con fermo		RU 0810-025 RU 0810-100 (13) <b>RU 0810-000</b>	RU 0811-100 RU 0811-255 (13) <b>RU 0811-000</b>	RU 0812-205 RU 0812-355 (9) <b>RU 0812-000</b>	RU 0813-280 RU 0813-430 (9) <b>RU 0813-000</b>
Satz mit Halter set with rack juego con soporte jeu avec porte-clous set con fermo		RU 0810-100 RU 0810-255 (13) <b>RU 0810-001</b>			
Halter, allein rack, only soporte, suelto porte-clous, seul solo fermo		2,4 mm <b>RU 0810-009</b>	3,2 mm <b>RU 0811-009</b>	4,8 mm <b>RU 0812-009</b>	6,4 mm <b>RU 0813-009</b>

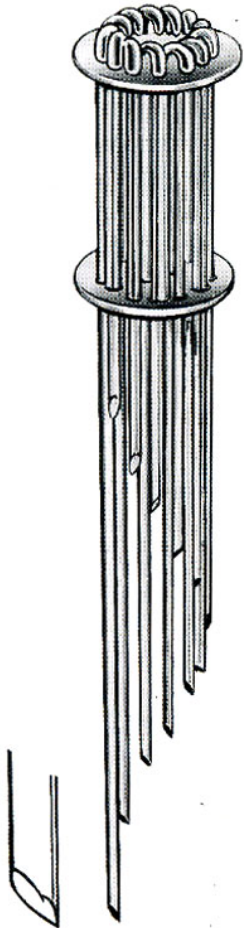





**Zubehör für Haken-Marknägel**  
**Accessories for Intramedullary Pins with Hooks**  
**Accesorios para clavos intramedulares con ganchos**  
**Accessoires pour clous médullaires avec crochets**  
**Accessori per ganci e chiodi intramidollari**



Vorbohrer  
 Reamers  
 Perforadores iniciales  
 Trépans  
 Alesatore

Ein- und Auschlaginstrumente  
 Driver-extractors  
 Impactores-Extractores  
 Impacteurs-Extracteurs  
 Impattatore-Estrattore

Biegehebel  
 Bender  
 Palanca  
 Levier pour plier  
 les clous  
 Leva per piegare

Drahtumführungs-  
 nadeln  
 Wire-guides  
 Aguja pasa-hilos  
 Passe-fils  
 Passafilo

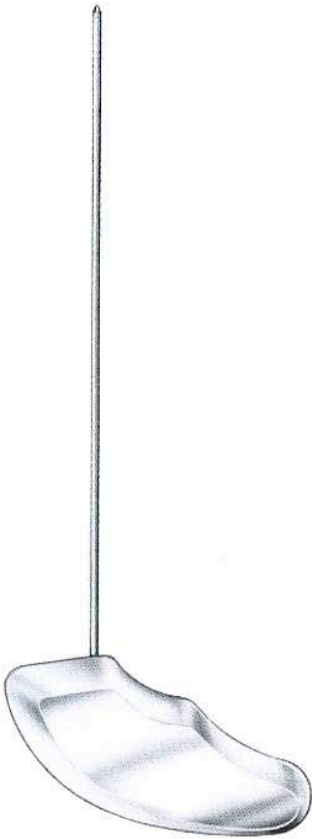

18 cm – 27 cm

für Nägel  
 for nails  
 para clavos  
 pour clous  
 per chiodi

Ø mm

2,4	RU 0815-024	RU 0816-024
3,2	RU 0815-032	RU 0816-032
4,8	RU 0815-048	RU 0816-048
6,4	RU 0815-064	RU 0816-064



17 cm/6<sup>3</sup>/<sub>4</sub>"



24 cm/9<sup>1</sup>/<sub>2</sub>"  
 RU 0817-000



25 cm

Fig. 1  
 klein – small – petit –  
 pequeña – piccolo  
 RU 0818-001

Fig. 2  
 mittel – medium – medium –  
 media – medio  
 RU 0818-002

Fig. 3  
 groß – large – grand –  
 grande – grande  
 RU 0818-003



**Schenkelhalsnägel**  
**Hip Nails**  
**Clavos para cuello del fémur fracturado**  
**Clous pour le col du fémur**  
**Chiodi per il collo del femore**



**Smith-Petersen**  
 12,7 mm Ø

60 mm, 2 <sup>1</sup> / <sub>4</sub> "	RU 0820-060
65 mm, 2 <sup>1</sup> / <sub>2</sub> "	RU 0820-065
70 mm, 2 <sup>3</sup> / <sub>4</sub> "	RU 0820-070
75 mm, 3"	RU 0820-075
80 mm, 3 <sup>1</sup> / <sub>4</sub> "	RU 0820-080
85 mm, 3 <sup>3</sup> / <sub>8</sub> "	RU 0820-085
90 mm, 3 <sup>1</sup> / <sub>2</sub> "	RU 0820-090
95 mm, 3 <sup>3</sup> / <sub>4</sub> "	RU 0820-095
100 mm, 4"	RU 0820-100
105 mm, 4 <sup>1</sup> / <sub>8</sub> "	RU 0820-105
110 mm, 4 <sup>1</sup> / <sub>4</sub> "	RU 0820-110
115 mm, 4 <sup>1</sup> / <sub>2</sub> "	RU 0820-115
120 mm, 4 <sup>3</sup> / <sub>4</sub> "	RU 0820-120
125 mm, 5"	RU 0820-125
130 mm, 5 <sup>1</sup> / <sub>8</sub> "	RU 0820-130
135 mm, 5 <sup>1</sup> / <sub>4</sub> "	RU 0820-135
140 mm, 5 <sup>1</sup> / <sub>2</sub> "	RU 0820-140
145 mm, 5 <sup>3</sup> / <sub>4</sub> "	RU 0820-145
150 mm, 6"	RU 0820-150
160 mm, 6 <sup>1</sup> / <sub>4</sub> "	RU 0820-160



Platte, allein  
 Plate, only  
 Placa, suelta  
 Plaque, seule  
 Solo placca

**RU 0825-020**

**Mc Laughlin**

**RU 0825-023**

**RU 0825-024**



komplett mit Fixierschraube, Federscheibe und Arretierungsplättchen  
 complete with fixing screw, locking washer, pronged washer  
 completa con tornillo fijador, arandela elástica y arandela de freno  
 complet avec vis de fixation, rondelle ressort et plaquette d'arrêt  
 completo con vite di fissaggio, rondella elastica e placchetta d'arresto

95 mm

5 Löcher – holes – orificios – trous – fori

**RU 0825-005**



**Zubehör für Schenkelhalsnägel**  
**Accessories for Hip Nails**  
**Accesorios para clavos cuello del fémur fracturado**  
**Accessoires pour clous pour le col de fémur**  
**Accessori per chiodi del collo femorale**



Steckschlüssel für Fixierschrauben  
Wrench for screws  
Llave, para tornillos fijadores  
Clé pour vis de fixation  
Chiave per viti di fissaggio

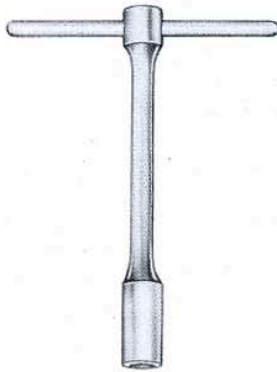

RU 0828-001

Vorbohrer – Nagelstarter  
Nail starter  
Iniciador  
Trépan  
Alesatore

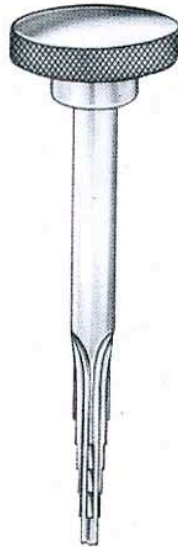

Rithey  
21 cm/8<sup>1</sup>/<sub>4</sub>"  
RU 0828-121

Vorschlagstahl  
Nail driver  
Conductor  
Conducteur  
Condotto



Lloyd  
21 cm/8<sup>1</sup>/<sub>4</sub>"  
RU 0828-219

Vorschlaginstrument und  
Nagelzieher  
Impactor and extractor  
Conductor y extractor  
Impacteur, extracteur  
Impattatore ed estrattore



Lloyd  
20 cm/8"  
RU 0828-320

Vorschlaginstrument  
Nail driver  
Conductor  
Conducteur  
Condotto



Sven Johansson  
16 cm/6<sup>1</sup>/<sub>4</sub>"  
RU 0828-416

Nagelzieher  
Nail extractor  
Extractor  
Extracteur  
Estrattore

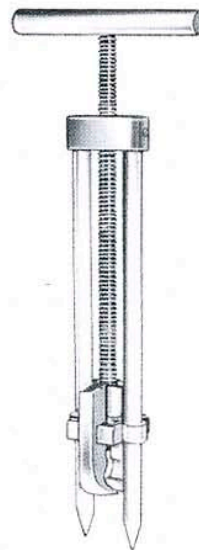

21 cm/8<sup>1</sup>/<sub>4</sub>"  
RU 0828-621