

# ALLGEMEINES INSTRUMENTARIUM

## GENERAL SURGICAL INSTRUMENTS

Seiten 39 - 152

Pages 39 - 152

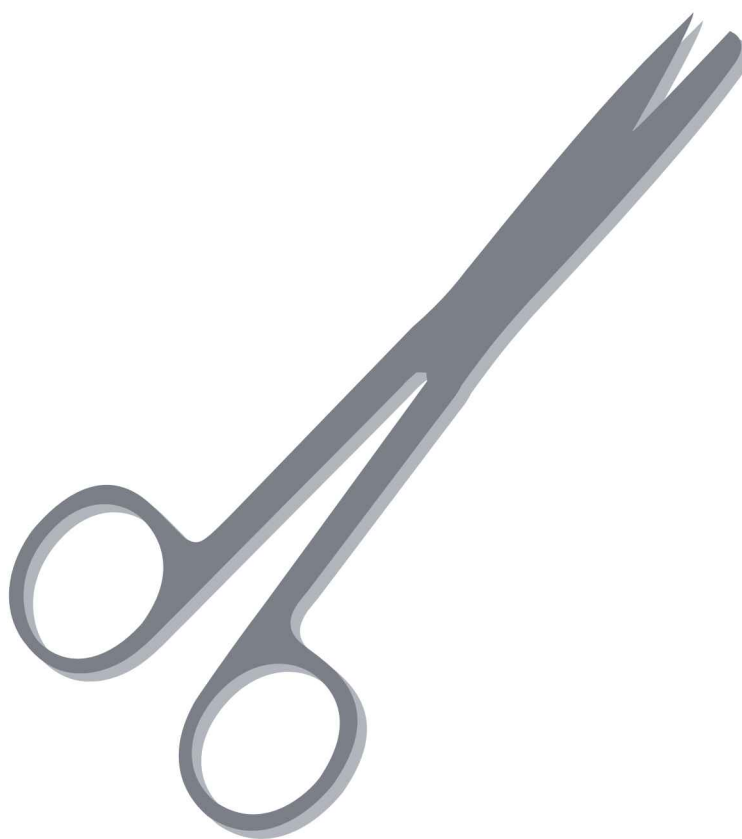

### Übersicht

Scheren, Klemmen, Zangen, Pinzetten  
Haken, Sperrer  
Wangen, Lippenhalter  
Skalpellgriffe, -klingen, Rasierklingen  
Sonden, Spatel, Watteträger  
Messinstrumente, Diagnostik  
Trokare, Kanülen, Spritzen  
Meißel, Stößel, Osteotome  
Löffel, Raspatorien, Elevatorien  
Hohlmeißel, Knochensplitterzangen  
Hämmer  
Nadelhalter, Nadeln  
Sonden, Absaugrohre

### Overview

Scissors, clamps, forceps  
Hooks, retractors  
Retractors  
Scalpel handles, – blades, razor blades  
Probes, spatulas, cotton applicators  
Measuring instruments, diagnostic  
Trocars, cannulas, syringes  
Bone chisels, pestles, osteotomes  
Bone curettes, raspatories, elevators  
Bone rongeur forceps, – cutting forceps  
Mallets  
Needle holders, needles  
Ligature conductors, Suction tubes

### Seiten / Pages

40-88, 128  
89-103  
103  
104-109  
110-113  
113-124  
125-127  
129-130  
131-135  
135-138  
138-139  
127, 140-149  
150-152

**CHIRURGISCHE SCHEREN  
OPERATING SCISSORS**



**Mod. Rudolf**  
14,5 cm/5¾"  
gerade/straight  
**RU 1000-14**

mit extra großen Ringen  
with extra large rings



**Standard**  
Fig. 1  
gerade/straight



**Standard**  
Fig. 2  
gerade/straight



**Standard**  
Fig. 3  
gerade/straight

11,5 cm/4½"	<b>RU 1001-11</b>	<b>RU 1002-11</b>	<b>RU 1003-11</b>
13 cm/5"	<b>RU 1001-13</b>	<b>RU 1002-13</b>	<b>RU 1003-13</b>
14,5 cm/5¾"	<b>RU 1001-14</b>	<b>RU 1002-14</b>	<b>RU 1003-14</b>
15,5 cm/6"	<b>RU 1001-15</b>	<b>RU 1002-15</b>	<b>RU 1003-15</b>
16,5 cm/6½"	<b>RU 1001-16</b>	<b>RU 1002-16</b>	<b>RU 1003-16</b>

**Rudolf**  
Tc



**Standard**  
14,5 cm/5¾"  
gerade/straight

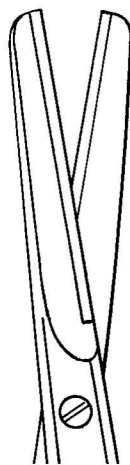

Fig. 1  
**RU 1004-14**

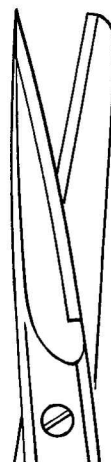

Fig. 2  
**RU 1006-14**



Fig. 3  
**RU 1008-14**

**CHIRURGISCHE SCHEREN  
OPERATING SCISSORS**



**Mod. Rudolf**  
14,5 cm/5¾"  
gebogen/curved  
**RU 1010-14**

mit extra großen Ringen  
with extra large rings



**Standard**  
Fig. 1  
gebogen/curved



**Standard**  
Fig. 2  
gebogen/curved



**Standard**  
Fig. 3  
gebogen/curved

11,5 cm/4½"	<b>RU 1011-11</b>	<b>RU 1012-11</b>	<b>RU 1013-11</b>
13 cm/5"	<b>RU 1011-13</b>	<b>RU 1012-13</b>	<b>RU 1013-13</b>
14,5 cm/5¾"	<b>RU 1011-14</b>	<b>RU 1012-14</b>	<b>RU 1013-14</b>
15,5 cm/6"	<b>RU 1011-15</b>	<b>RU 1012-15</b>	<b>RU 1013-15</b>
16,5 cm/6½"	<b>RU 1011-16</b>	<b>RU 1012-16</b>	<b>RU 1013-16</b>

**Rudolf**<sup>®</sup>  
Tc

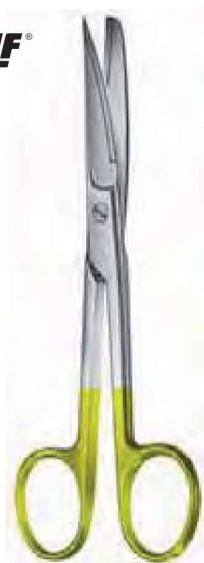

**Standard**  
14,5 cm/5¾"  
gebogen/curved

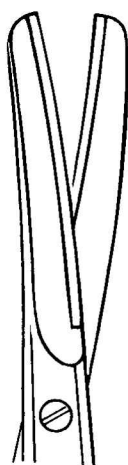

Fig. 1  
**RU 1014-14**



Fig. 2  
**RU 1016-14**



Fig. 3  
**RU 1018-14**

**CHIRURGISCHE SCHEREN, PRÄPARIERSCHEREN**  
**OPERATING SCISSORS, DISSECTING SCISSORS**



**Standard  
- Graziol -**  
*gerade/straight*



**Standard  
- Graziol -**  
*gebogen/curved*



13 cm/5"

**RU 1021-13**

**RU 1022-13**

**RU 1023-13**

**RU 1031-13**

**RU 1032-13**

**RU 1033-13**

14,5 cm/5¾"

**RU 1021-14**

**RU 1022-14**

**RU 1023-14**

**RU 1031-14**

**RU 1032-14**

**RU 1033-14**



**Lexer**  
16 cm/6¼"  
**RU 1101-16**

**Rudolf**<sup>®</sup>  
SUPERCUT



**Lexer**  
16 cm/6¼"  
*gezahnt/serrated*  
**RU 1101-16 MC**

**Rudolf**<sup>®</sup>  
Tc



**Lexer**  
16 cm/6¼"  
**RU 1103-16**



**CHIRURGISCHE SCHEREN, PRÄPARIERSCHEREN  
OPERATING SCISSORS, DISSECTING SCISSORS**



**Mayo**  
gerade/straight  
**RU 1250-14**

14,5 cm/5¾"



gebogen/curved  
**RU 1251-14**

**Kudolf**<sup>®</sup>  
Tc



gerade/straight  
**RU 1252-14**

**Mayo**  
14,5 cm/5¾"

gebogen/curved  
**RU 1253-14**



**Baby-Metzenbaum**  
gerade/straight  
**RU 1280-11**

11,5 cm/4½"



gebogen/curved  
**RU 1281-11**

**Kudolf**<sup>®</sup>  
SUPERCUT



gerade, gezahnt  
straight, serrated  
**RU 1280-11 MC**

**Baby-Metzenbaum**  
11,5 cm/4½"

gebogen, gezahnt  
curved, serrated  
**RU 1281-11 MC**

**PRÄPARIERSCHEREN  
DISSECTING SCISSORS**



**Metzenbaum-Fino**

14,5 cm/5¾"

gerade/straight  
**RU 1290-14**



gebogen/curved  
**RU 1291-14**

**Rudolf**  
SUPERCUT



**Metzenbaum-Fino**

14,5 cm/5¾"

gerade, gezahnt  
straight, serrated  
**RU 1290-14 MC**

gebogen, gezahnt  
curved, serrated  
**RU 1291-14 MC**



**Metzenbaum**

14,5 cm/5¾"  
gerade/straight  
**RU 1301-14**

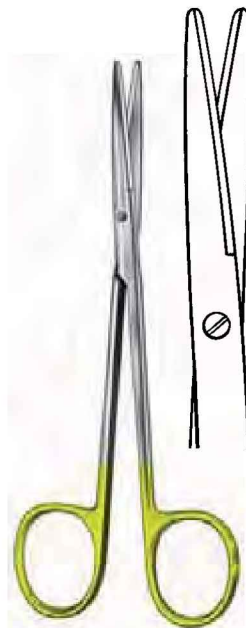

**Metzenbaum**

14,5 cm/5¾"  
gerade/straight  
**RU 1304-14**

**Rudolf**  
Tc



**Metzenbaum-Fino**

14,5 cm/5¾"  
gerade/straight  
**RU 1306-14**

**PRÄPARIERSCHEREN  
DISSECTING SCISSORS**



**Metzenbaum**  
14,5 cm/5¾"  
gebogen/*curved*  
**RU 1311-14**

**Rudolf**<sup>®</sup>  
SUPERCUT



**Metzenbaum**  
14,5 cm/5¾"  
gebogen, gezahnt  
*curved, serrated*  
**RU 1311-14 MC**

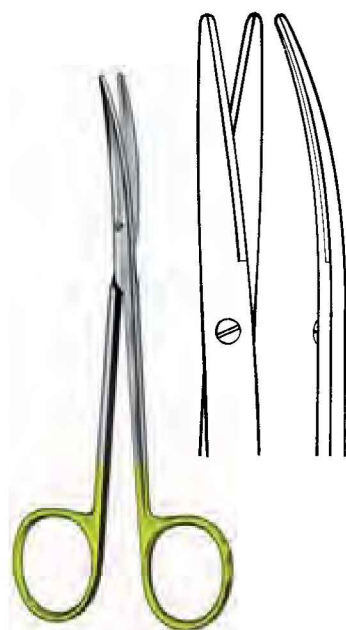

**Metzenbaum**  
14,5 cm/5¾"  
gebogen/*curved*  
**RU 1314-14**

**Rudolf**<sup>®</sup>  
Tc



**Metzenbaum-Fino**  
14,5 cm/5¾"  
gebogen/*curved*  
**RU 1316-14**

**PRÄPARIERSCHEREN  
DISSECTING SCISSORS**



**Metzenbaum**  
gerade/straight  
18 cm/7" **RU 1321-18**  
20 cm/8" **RU 1321-20**

**Rudolf**<sup>®</sup>  
Tc



**Metzenbaum-Fino**  
18 cm/7"  
gerade/straight  
**RU 1326-18**



**Metzenbaum-Fino**  
gebogen/curved  
18 cm/7" **RU 1330-18**  
20 cm/8" **RU 1330-20**



**Metzenbaum**  
gebogen/curved  
18 cm/7" **RU 1331-18**  
20 cm/8" **RU 1331-20**

**Rudolf**<sup>®</sup>  
SUPERCUT



**Metzenbaum  
Metzenbaum-Fino**

gebogen, gezahnt  
curved, serrated

**Metzenbaum**  
18 cm/7" **RU 1331-18 MC**  
20 cm/8" **RU 1331-20 MC**

**Metzenbaum-Fino**  
18 cm/7" **RU 1330-18 MC**

**PRÄPARIERSCHEREN, FEINE CHIRURGISCHE SCHEREN**  
**DISSECTING SCISSORS, FINE OPERATING SCISSORS**



**Kudolf**<sup>®</sup>  
Tc



**Metzenbaum**  
gebogen/*curved*

**RU 1334-18**

**RU 1334-20**

**Metzenbaum-Fino**  
gebogen/*curved*

**RU 1336-18**

**RU 1336-20**

18 cm/7"

20 cm/8"



12 cm/4¾"  
gerade/*straight*  
**RU 1503-12**

12 cm/4¾"  
gebogen/*curved*  
**RU 1513-12**

**Kudolf**<sup>®</sup>  
SUPERCUT



**Plastic Surgery**  
12 cm/4¾"

gerade, gezahnt  
*straight, serrated*  
**RU 1503-12 MC**

gebogen, gezahnt  
*curved, serrated*  
**RU 1513-12 MC**

**FEINE CHIRURGISCHE SCHEREN  
FINE OPERATING SCISSORS**

**Rudolf**<sup>®</sup>  
SUPERCUT



11,5 cm/4½"

gerade, gezahnt  
straight, serrated  
**RU 1518-11 MC**

gebogen, gezahnt  
curved, serrated  
**RU 1519-11 MC**

gerade  
straight



**Wagner**  
12 cm/4¾"



Fig. 1

**RU 1521-12**



Fig. 2

**RU 1522-12**



Fig. 3

**RU 1523-12**

gebogen  
curved



Fig. 1

**RU 1524-12**



Fig. 2

**RU 1525-12**



Fig. 3

**RU 1526-12**



**FEINE CHIRURGISCHE SCHEREN  
FINE OPERATING SCISSORS**



gerade/straight

**RU 1580-15** 15 cm/6"  
**RU 1580-18** 18 cm/7"

**Reynolds**



gebogen/curved

**RU 1581-15**  
**RU 1581-18**

**Rudolf**<sup>®</sup>  
SUPERCUT



**Reynolds**

15 cm/6"

gerade, gezahnt  
straight, serrated  
**RU 1580-15 MC**

gebogen, gezahnt  
curved, serrated  
**RU 1582-15 MC**

**Rudolf**<sup>®</sup>  
SUPERCUT



**Jameson**

gezahnt/serrated

**RU 1583-15 MC** 15 cm/6"  
**RU 1583-18 MC** 18 cm/7"



**Jameson-Werber**

13 cm/5"

gebogen/curved  
**RU 1584-13**



**Jameson-Werber**

15 cm/6"

gebogen/curved  
**RU 1584-15**

**FEINE SCHEREN**  
**FINE SCISSORS**

**Rudolf**<sup>®</sup>  
SUPERCUT



11,5 cm/4½"

gerade, gezahnt	gebogen, gezahnt
<i>straight, serrated</i>	<i>curved, serrated</i>
<b>RU 1630-09 MC</b>	<b>RU 1631-09 MC</b>
<b>RU 1630-11 MC</b>	<b>RU 1631-11 MC</b>



9 cm/3½"

**RU 1636-09**

RU 1630-09, 10, 11 und/*and*  
RU 1631-09, 10, 11  
siehe Seite 62/*see page 62*



**Baby-Lexer (Knapp)**

10 cm/4"

gerade/*straight*  
**RU 1650-10**



gebogen/*curved*  
**RU 1651-10**



gerade/*straight*  
**RU 1670-14**



**Joseph**

14 cm/5½"

gebogen/*curved*  
**RU 1671-14**

**PRÄPARIERSCHEREN  
DISSECTING SCISSORS**



**Kilner (Ragnell)**

**RU 1675-12** 12 cm/4¾"  
**RU 1675-13** 13 cm/5"  
**RU 1675-15** 15 cm/6"



**Mod. Rudolf**  
11 cm/4½"  
gebogen, gezahnt  
*curved, serrated*  
**RU 1676-11 MC**

**Rudolf**<sup>®</sup>  
SUPERCUT



**Mod. Rudolf**  
14 cm/5½"  
gebogen, gezahnt  
*curved, serrated*  
**RU 1676-14 MC**

**PRÄPARIERSCHEREN  
DISSECTING SCISSORS**

**Rudolf**<sup>®</sup>  
SUPERCUT



**Reynolds**  
13 cm/5"  
gezahnt/serrated  
RU 1677-13 MC

**Rudolf**<sup>®</sup>  
SUPERCUT

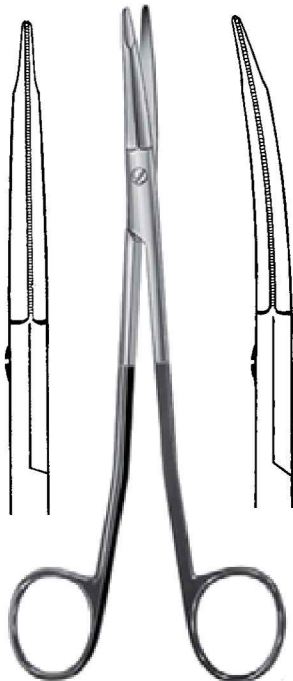

**Freeman-Kaye**  
18 cm/7"  
gerade, gezahnt    gebogen, gezahnt  
straight, serrated    curved, serrated  
RU 1680-18 MC    RU 1681-18 MC

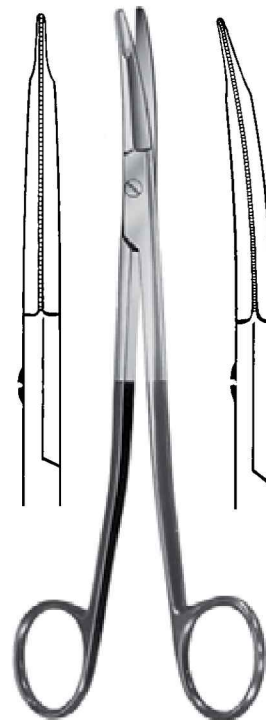

**Freeman-Gorney**  
19 cm/7½"  
gerade, gezahnt    gebogen, gezahnt  
straight, serrated    curved, serrated  
RU 1682-19 MC    RU 1683-19 MC

**PRÄPARIERSCHEREN  
DISSECTING SCISSORS**

**Rudolf**<sup>®</sup>  
SUPERCUT



**Gorney**  
12,5 cm/5"  
gerade/straight  
gezahnt/serrated  
**RU 1688-12 MC**



**Gorney**  
12,5 cm/5"  
gebogen/curved  
gezahnt/serrated  
**RU 1689-12 MC**

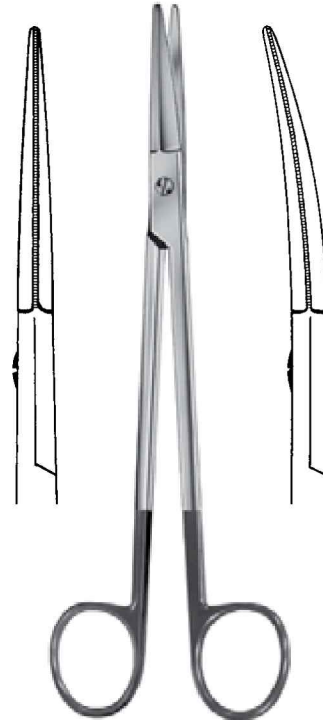

**Gorney**  
19 cm/7½"  
gerade  
straight  
**RU 1688-19 MC**



gebogen/curved  
**RU 1689-19 MC**



**Freeman**  
18 cm/7"  
gebogen/curved  
**RU 1693-18 MC**



10 cm/4½"  
**RU 1706-10**  
Speichelgangschere  
Salival scissors



**Mc Indoe**  
19 cm/7½"  
**RU 1730-19**



15 cm/6"  
**RU 1792-15**  
Nerv-Präparierschere  
Nerve dissecting scissors

**TONSILLENSCHEREN  
TONSIL SCISSORS**



**Böttcher**  
18 cm/7" 18 cm/7"  
stumpf/blunt spitz/sharp  
**RU 1810-18 RU 1811-18**



**Prince**  
17,5 cm/7"  
**RU 1815-17**



**Tönnis**  
18 cm/7"  
gerade/straight  
**RU 1820-18**



**Tönnis**  
18 cm/7"  
gebogen/curved  
**RU 1821-18**



**Tönnis-Adson**  
17,5 cm/7"  
**RU 1825-17**

**Rudolf**<sup>®</sup>  
Tc

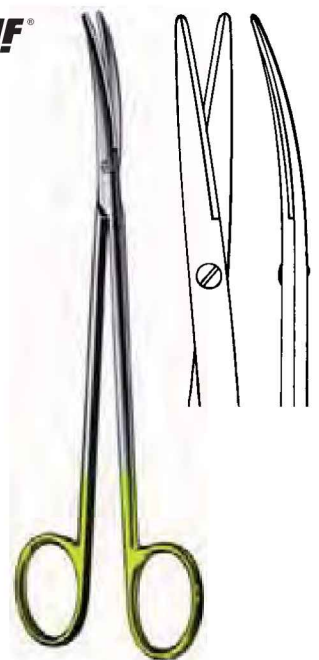

**Tönnis-Adson**  
17,5 cm/7"  
**RU 1829-17**



**TONSILLENSCHEREN, NASENSCHEREN  
TONSIL SCISSORS, NASAL SCISSORS**



**Good**  
19 cm/7½"  
**RU 1845-19**



**Heymann**  
18 cm/7"  
**RU 2115-18**

**Rudolf**<sup>®</sup>  
SUPERCUT



**Heymann**  
18 cm/7"  
gezahnt/serrated  
**RU 2115-18 MC**



**Heymann**  
19,5 cm/7½"  
**RU 2116-19**

**NASENSCHEREN  
NASAL SCISSORS**



**Kirstein**  
19 cm/7½"  
gezahnt/serrated  
**RU 2117-18**



**Cottle-Masing**  
10,5 cm/4½"  
spitz/sharp      stumpf/blunt  
**RU 2120-10      RU 2121-10**



**Kilner**  
11,5 cm/4½"  
gerade, spitz  
straight, sharp  
**RU 2124-11**

**NASENSCHEREN  
NASAL SCISSORS**



**Rudolf**<sup>®</sup>  
Tc  
RU 2129-13

**Fomon**  
13 cm/5"  
RU 2130-13

**Rudolf**<sup>®</sup>  
SUPERCUT



**Fomon**  
13 cm/5"  
gezahnt/serrated  
RU 2130-13 MC



**Fomon**  
13,5 cm/5¼"  
schlank/gezahnt  
delicate, serrated  
RU 2131-13

**Rudolf**<sup>®</sup>  
SUPERCUT



**Fomon**  
13,5 cm/5¼"  
schlank/gezahnt  
delicate, serrated  
RU 2131-13 MC

**NASENSCHEREN  
NASAL SCISSORS**



**Fomon**  
13,5 cm/5¼"  
**RU 2132-13**

**Rudolf**<sup>®</sup>  
SUPERCUT



**Fomon**  
13 cm/5"  
gezahnt/serrated  
**RU 2132-13 MC**



**Cottle**  
16 cm/6¼"  
**RU 2135-16**

**Rudolf**<sup>®</sup>  
SUPERCUT



**Cottle**  
16 cm/6¼"  
gezahnt/serrated  
**RU 2135-16 MC**



**Halle**  
19 cm/7½"  
**RU 2140-19**

**Rudolf**<sup>®</sup>  
Tc  
**RU 2136-16**

**MIKROSCHEREN  
MICRO SCISSORS**



12 cm/4 $\frac{3}{4}$ "  
gerade/straight  
**RU 2370-12**



16 cm/6 $\frac{1}{4}$ "  
gerade/straight  
**RU 2370-16**



12 cm/4 $\frac{3}{4}$ "  
gebogen/curved  
**RU 2371-12**



16 cm/6 $\frac{1}{4}$ "  
gebogen/curved  
**RU 2371-16**

**MIKROSCHEREN  
MICRO SCISSORS**

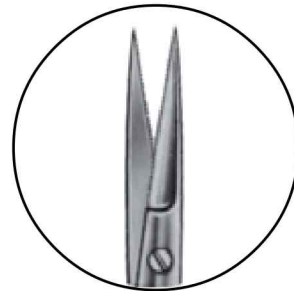

gezahnt  
serrated



16 cm/6¼"  
gerade/straight  
**RU 2372-16**



16 cm/6¼"  
gebogen/curved  
**RU 2373-16**



**Millesi**  
16 cm/6¼"  
gerade/straight  
**RU 2376-16**



**Millesi**  
16 cm/6¼"  
gebogen/curved  
**RU 2377-16**



**FEINE SCHEREN  
FINE SCISSORS**



	<b>Fino</b> gerade/straight	<b>Fino</b> gebogen/curved
10,5 cm/4¼"	<b>RU 2418-10</b>	<b>RU 2419-10</b>
11,5 cm/4½"	<b>RU 2418-11</b>	<b>RU 2419-11</b>



	gerade/straight	gebogen/curved	<b>Fino</b> gerade/straight	<b>Fino</b> gebogen/curved
9,5 cm/3¾"	<b>RU 2420-09</b>	<b>RU 2421-09</b>	<b>RU 2422-09</b>	<b>RU 2423-09</b>
10,5 cm/4¼"	<b>RU 2420-10</b>	<b>RU 2421-10</b>	<b>RU 2422-10</b>	<b>RU 2423-10</b>
11,5 cm/4½"	<b>RU 2420-11</b>	<b>RU 2421-11</b>	<b>RU 2422-11</b>	<b>RU 2423-11</b>

**FEINE SCHEREN  
FINE SCISSORS**

**Rudolf**<sup>®</sup>  
Tc

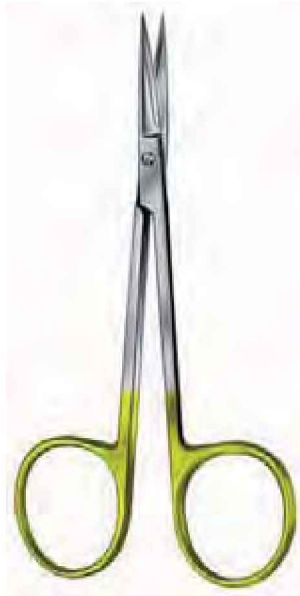

gerade/straight  
**RU 2406-11**

11,5 cm/4½"



gebogen/curved  
**RU 2407-11**

**Rudolf**<sup>®</sup>  
SUPERCUT



gerade, gezahnt  
straight, serrated  
**RU 2406-11 MC**

11,5 cm/4½"

gebogen, gezahnt  
curved, serrated  
**RU 2407-11 MC**



gerade/straight

**RU 1630-09**

**RU 1630-10**

**RU 1630-11**

**Standard**

9 cm/3½"

10,5 cm/4¼"

11,5 cm/4½"



gebogen/curved

**RU 1631-09**

**RU 1631-10**

**RU 1631-11**

**FEINE SCHEREN  
FINE SCISSORS**



**Stevens**

	gerade straight	gebogen curved
10,5 cm/4¼"	<b>RU 2430-10</b>	<b>RU 2431-10</b>
11,5 cm/4½"	<b>RU 2430-11</b>	<b>RU 2431-11</b>



spitz/*pointed*

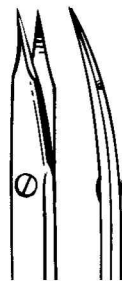

stumpf/*blunt*



**Rudolf**<sup>®</sup>  
**SUPERCUT**



**Stevens**

	11,5 cm/4½"
gerade, gezahnt straight, serrated	gebogen, gezahnt curved, serrated
<b>RU 2440-11 MC</b>	<b>RU 2441-11 MC</b>



**Graefe**

10,5 cm/4¼"  
**RU 2455-10**



**Wilmer**

10 cm/4"  
**RU 2457-10**



	11,5 cm/4½"
gerade, straight <b>RU 2460-11</b>	gebogen, curved <b>RU 2461-11</b>
Strabismusscheren/ <i>Strabismus scissors</i>	



**FEINE SCHEREN**  
**FINE SCISSORS**

**Rudolf**<sup>®</sup>  
Tc



11,5 cm/4½"

gerade/straight **RU 2462-11**  
Strabismusscheren/*Strabismus scissors*

gebogen/curved **RU 2463-11**



**Rudolf**<sup>®</sup>  
SUPERCUT

11,5 cm/4½"

gerade, gezahnt  
straight, serrated **RU 2462-11 MC**  
Strabismusscheren/*Strabismus scissors*

gebogen, gezahnt  
curved, serrated **RU 2463-11 MC**



**Chadwick**  
11 cm/4½"  
**RU 2470-11**



9,5 cm/3¾"

gerade/straight **RU 2476-02**  
gebogen/curved **RU 2476-03**

**LIGATURSCHEREN, DRAHTSCHEREN  
LIGATURE SCISSORS, WIRE CUTTING SCISSORS**



**Littauer**  
14 cm/5½"  
**RU 2500-14**



**Spencer**  
9 cm/3½"  
**RU 2510-09**



**Spencer**  
**RU 2510-10** 10,5 cm/4¼"  
**RU 2510-12** 12 cm/4¾"



**Northbent**  
12,5 cm/5"  
**RU 2520-12**



**Universal**  
12 cm/4¾"  
gezahnt/serrated  
**RU 2600-12**



**Universal**  
12 cm/4¾"  
gezahnt/serrated  
**RU 2601-12**

**VERBANDSCHEREN  
BANDAGE SCISSORS**



**Universal**  
14,5 cm/5¾"  
**RU 2602-14**



**Mod. Rudolf**  
16 cm/6¼"  
**RU 2602-16**



**Universal**  
18 cm/7"  
**RU 2602-18**



**Harvey**  
12,5 cm/5"  
gezahnt/*serrated*  
**RU 2610-12**



**Schuknecht**  
10 cm/4"  
gezahnt/*serrated*  
**RU 2615-10**



**Lister**  
**RU 2650-09** 9,0 cm/3½"  
**RU 2650-11** 11,0 cm/4½"  
**RU 2650-14** 14,0 cm/5½"  
**RU 2650-15** 15,5 cm/6"  
**RU 2650-18** 18,0 cm/7"



**Rudolf**<sup>®</sup>  
Tc



**Goldmann-Fox**  
13 cm/5"  
gebogen, gezahnt  
*curved, serrated*  
**RU 2903-13**



**Quinby**  
12 cm/4¾"  
**RU 2911-12**



11 cm/4½"  
gezahnt/*serrated*  
**RU 2942-11**



*gerade/straight*

9,0 cm/3½"  
10,5 cm/4¼"

**RU 2980-09**  
**RU 2980-10**



*gebogen/curved*

**RU 2981-09**  
**RU 2981-10**

**ARTERIENKLEMMEN  
HEMOSTATIC FORCEPS**



gerade  
straight

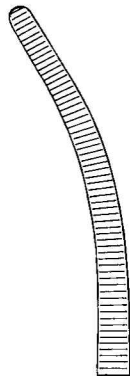

gebogen  
curved

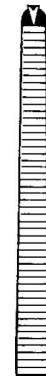

gerade  
straight

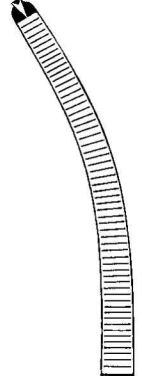

gebogen  
curved

Rochester-Péan		cm	in	Ochsner-Kocher	
RU 3000-13	RU 3001-13	13	5"	RU 3010-13	RU 3011-13
RU 3000-14	RU 3001-14	14	5½"	RU 3010-14	RU 3011-14
RU 3000-16	RU 3001-16	16	6¼"	RU 3010-16	RU 3011-16
RU 3000-18	RU 3001-18	18	7"	RU 3010-18	RU 3011-18
RU 3000-20	RU 3001-20	20	8"	RU 3010-20	RU 3011-20



gerade  
straight



gebogen  
curved

◀ fein  
fine ▶



gerade  
straight

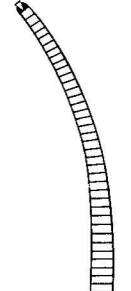

gebogen  
curved

Péan		cm	in	Kocher	
RU 3020-13	RU 3021-13	13	5"	RU 3030-13	RU 3031-13
RU 3020-14	RU 3021-14	14	5½"	RU 3030-14	RU 3031-14

**ARTERIENKLEMMEN  
HEMOSTATIC FORCEPS**



**Kelly**  
14 cm/5½"

**Kelly-Rankin**  
16 cm/6¼"



**RU 3050-14**

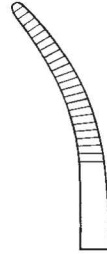

**RU 3051-14**

14 cm/5½"



**RU 3050-16**

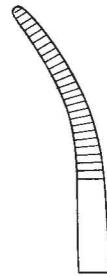

**RU 3051-16**

16 cm/6¼"

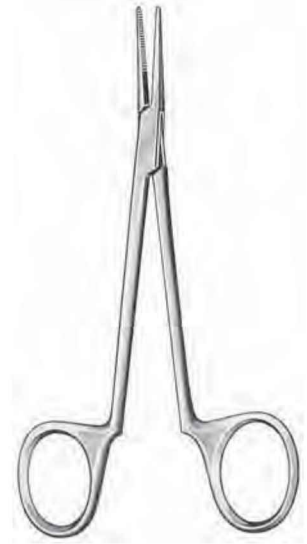

14 cm/5½"  
gerade  
straight gebogen  
curved

**RU 3068-14**

**RU 3069-14**



**Crile**  
14 cm/5½"

**Crile-Rankin**  
16 cm/6¼"

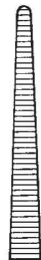

**RU 3070-14**

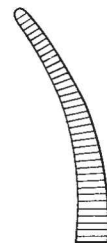

**RU 3071-14**

14 cm/5½"

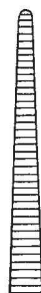

**RU 3070-16**



**RU 3071-16**

16 cm/6¼"



**RU 3072-14**



**RU 3073-14**



**Baby-Crile**  
14 cm/5½"

**ARTERIENKLEMMEN  
HEMOSTATIC FORCEPS**

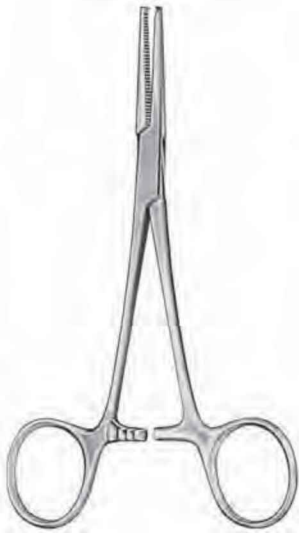

**Crile**

14 cm/5½"

**Crile-Rankin**

16 cm/6¼"

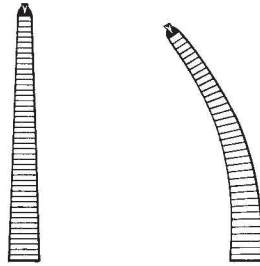

14 cm/5½"  
**RU 3074-14**    **RU 3075-14**

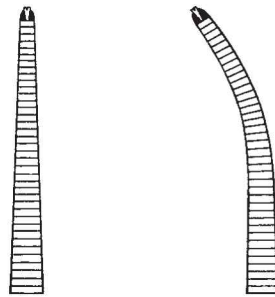

16 cm/6¼"  
**RU 3074-16**    **RU 3075-16**



**Baby-Crile**

14 cm/5½"



**RU 3076-14**



**RU 3077-14**



**Leriche**

15 cm/6"

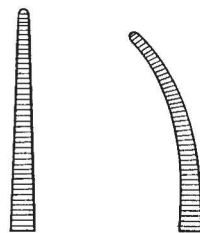

**RU 3080-15**    **RU 3081-15**

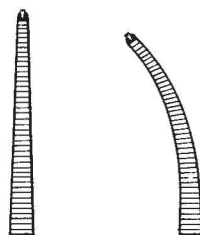

**RU 3082-15**    **RU 3083-15**



**Providence**

14 cm/5½"



**RU 3090-14**



**RU 3091-14**

**ARTERIENKLEMMEN  
HEMOSTATIC FORCEPS**



9,5 cm/3¾"  
**RU 3097-09**  
Ligaturklemme, glatt  
*Ligature forceps, smooth*



**Halsted-Mosquito**  
12 cm/4¾"  
14 cm/5½"

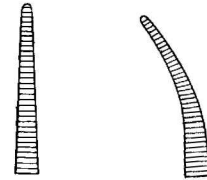

**RU 3100-12 RU 3101-12**  
**RU 3100-14 RU 3101-14**

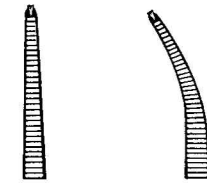

**RU 3110-12 RU 3111-12**  
**RU 3110-14 RU 3111-14**



**Halsted-Mosquito**  
18 cm/7"  
21 cm/8¼"

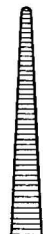

**RU 3100-18**  
**RU 3100-21**

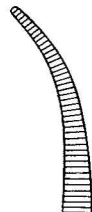

**RU 3101-18**  
**RU 3101-21**

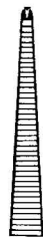

**RU 3110-18**  
**RU 3110-21**



**RU 3111-18**  
**RU 3111-21**

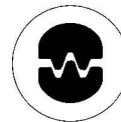

**Rudolf**<sup>®</sup>  
DEBAKEY



**Mosquito**  
12 cm/4¾"

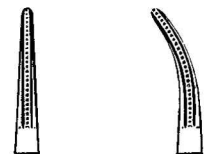

**RU 7680-12 RU 7681-12**

Atrauma-Arterienklemmen  
*Atrauma hemostatic forceps*

**ARTERIENKLEMMEN  
HEMOSTATIC FORCEPS**



**Jacobson-Halsted**  
13 cm/5"  
sehr fein/very fine

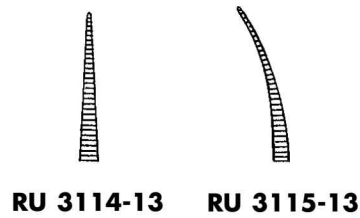

**Micro-Mosquito**  
10 cm/4"  
12 cm/4¾"

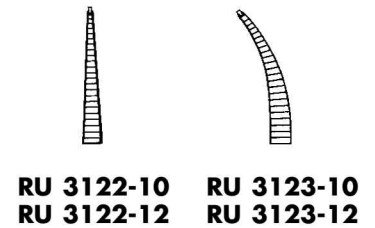
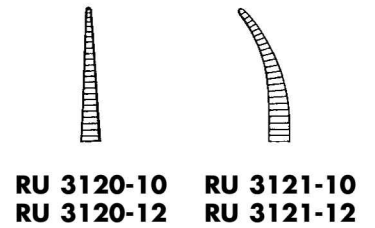

12 cm/4¾"  
**RU 3137-12**

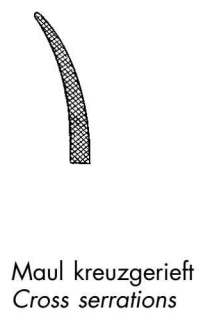

**Hartmann**  
10 cm/4"

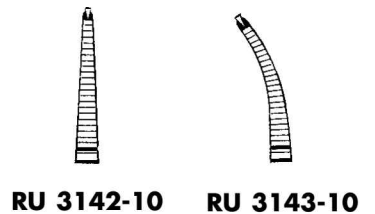
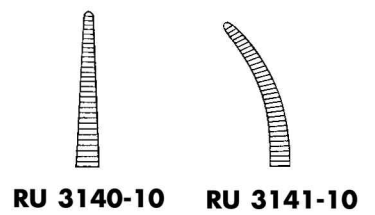



**ARTERIENKLEMMEN, TONSILLEN-KLEMMZANGEN  
HEMOSTATIC FORCEPS, TONSIL FORCEPS**



**Mosquito-Dandy**  
12 cm/4¾"  
seitwärts gebogen  
*lateral curved*

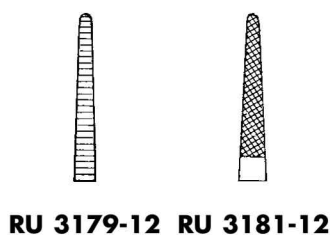

**Adson**  
18,5 cm/7¼"

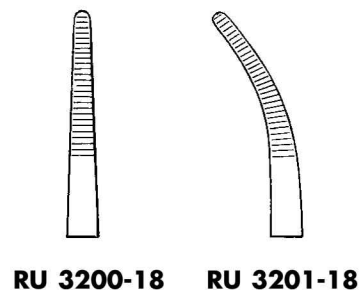

**Baby-Adson**

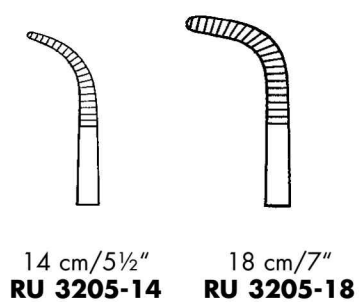

**Schnidt**  
19 cm/7½"  
Tonsillen-Klemmzange  
*Tonsil forceps*

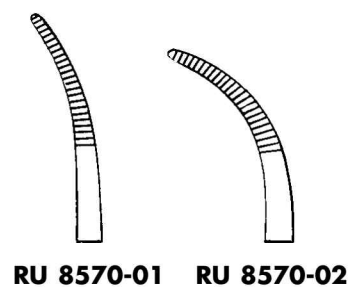



**ARTERIENKLEMMEN, TONSILLENKLEMMEN,  
HEMOSTATIC FORCEPS, TONSIL FORCEPS**



**Birkett**  
19 cm/7½"



**RU 3210-19**

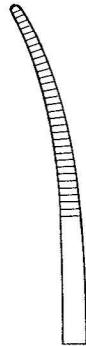

**RU 3211-19**



**Baby-Overholt**  
13,5 cm/5¼"  
**RU 3289-14**

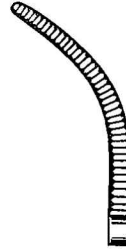

**Baby-Mixter**  
14 cm/5½"      18 cm/7"  
**RU 3328-14      RU 3328-18**

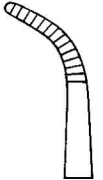

**Negus**  
19 cm/7½"

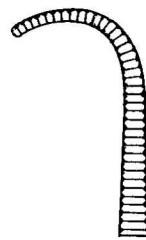

Fig. 1  
**RU 3387-01**



Fig. 2  
**RU 3387-02**



**Mikulicz**  
18,5 cm/7¼"  
**RU 3499-18**



**Mikulicz**  
20 cm/8"  
**RU 3501-20**

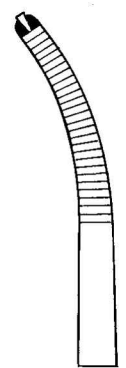

**TONSILLENKLEMMEN, TUCHKLEMMEN**  
**TONSIL FORCEPS, TOWEL FORCEPS**



**Mikulicz**  
18 cm/7"  
**RU 3504-18**



**Mikulicz**  
20 cm/8"

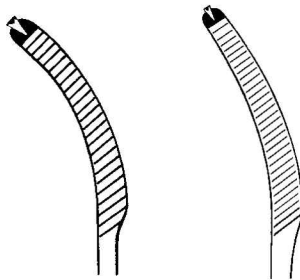

**RU 3505-20**    **RU 3506-20**



**Schädel**  
9 cm/3½"  
**RU 3550-09**



**Jones**  
**RU 3552-05** 5 cm/2"  
**RU 3552-09** 9 cm/3½"



**Backhaus**  
**RU 3600-09** 9 cm/3½"  
**RU 3600-11** 11 cm/4½"  
**RU 3600-13** 13 cm/5"  
**RU 3600-15** 15 cm/6"

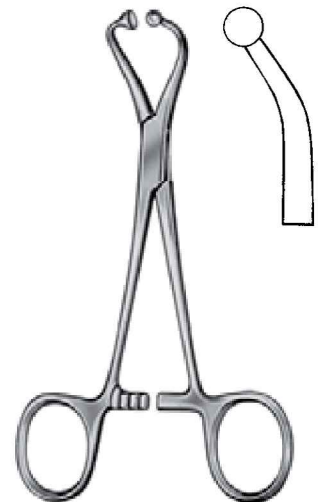

**RU 3617-11** 11 cm/4½"  
**RU 3617-13** 13 cm/5"

**KORN-(POLYPEN) ZANGEN, SINUSKLEMMEN  
POLYPUS AND DRESSING FORCEPS, SINUS FORCEPS**



**Ulrich**  
22 cm/8¾"

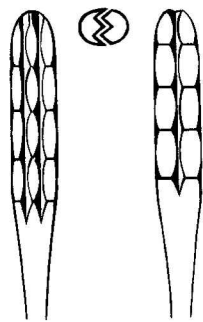

gerade  
straight  
**RU 3800-22**

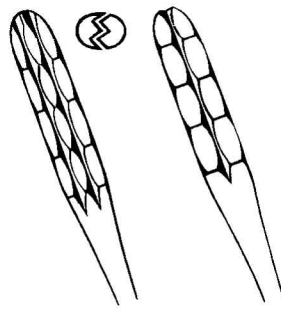

gebogen  
curved  
**RU 3801-22**



**Lister**

**RU 3810-12** 12,5 cm/5"  
**RU 3810-16** 16 cm/6¼"  
**RU 3810-18** 18 cm/7"  
Sinusklemme/Sinus forceps



17,5 cm/7"  
gebogen/curved  
**RU 3815-17**



**Gross-Maier**

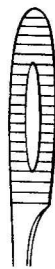

gerade/straight  
**RU 3860-20** 20 cm/8"  
**RU 3860-25** 25 cm/10"

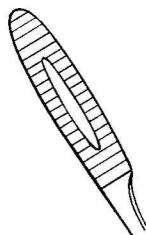

gebogen/curved  
**RU 3861-20** 20 cm/8"  
**RU 3861-25** 25 cm/10"



**Duplay**  
20 cm/8"  
**RU 3881-20**

**BULLDOGGKLEMMEN  
BULLDOG CLAMPS**



**Rudolf**<sup>®</sup>  
DEBAKEY



**De Bakey-Hess**  
4,5 cm/1¾"  
**RU 3936-20**

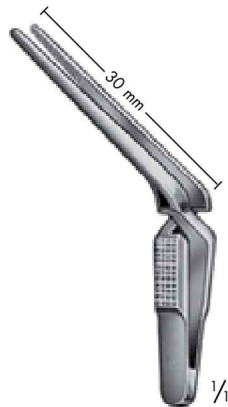

**De Bakey-Hess**  
5,5 cm/2¼"  
**RU 3936-30**



**RU 7586-07**  
**RU 7586-08**

8 cm/3⅞"  
9 cm/3½"



**RU 7587-07**  
**RU 7587-08**



23 cm/9"  
**RU 7586-00**  
Anlegezange/Setting forceps



**FASSZANGEN  
GRASPING FORCEPS**



**Lahey**  
15 cm/6"  
**RU 6280-15**  
Kropffasszange  
Goitre grasping forceps



**Allis**  
15 cm/6"  
Zähne 4:5 **RU 6500-15**  
teeth 5:6 **RU 6502-15**



**Czerny**  
20,5 cm 8¼"  
**RU 7175-20**



**Braun**  
15,5 cm/6¼"  
**RU 7197-16**

**ANATOMISCHE PINZETTEN  
DRESSING FORCEPS**

**Rudolf**<sup>®</sup>  
Tc



schmal  
narrow



cm	in	Standard	Standard	Engl. Modell	Cottle
10,5	4¼	<b>RU 4000-10</b>			
11,5	4½	<b>RU 4000-11</b>		<b>RU 4010-11</b>	
13,0	5	<b>RU 4000-13</b>		<b>RU 4010-13</b>	<b>RU 4024-13</b>
14,5	5¾	<b>RU 4000-14</b>	<b>RU 4002-14</b>	<b>RU 4010-14</b>	
15,0	6	<b>RU 4000-15</b>			<b>RU 4026-15</b>
16,0	6¼	<b>RU 4000-16</b>	<b>RU 4002-16</b>	<b>RU 4010-16</b>	
18,0	7	<b>RU 4000-18</b>	<b>RU 4002-18</b>	<b>RU 4010-18</b>	
20,0	8	<b>RU 4000-20</b>	<b>RU 4002-20</b>	<b>RU 4010-20</b>	
25,0	10	<b>RU 4000-25</b>	<b>RU 4002-25</b>	<b>RU 4010-25</b>	

**Rudolf**<sup>®</sup>  
Tc

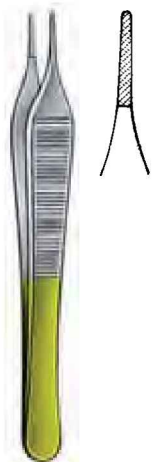

cm	in	Ewald	Jacobson-Adson	Mikro-Adson	Adson Standard	Adson
12,0	4¾	<b>RU 4032-12</b>	<b>RU 4033-12</b>	<b>RU 4034-12</b>	<b>RU 4035-12</b>	<b>RU 4036-12</b>
15,5	6		<b>RU 4033-15</b>	<b>RU 4034-15</b>	<b>RU 4035-15</b>	<b>RU 4036-15</b>



**ANATOMISCHE PINZETTEN, TUMORFASSPINZETTEN**  
**DRESSING FORCEPS, TUMOR GRASPING FORCEPS**









**Rudolf**<sup>®</sup>  
Tc



cm	in	McIndoe	Semken	Semken
12	4¾		<b>RU 4040-12</b>	
15	6	<b>RU 4038-15</b>	<b>RU 4040-15</b>	<b>RU 4042-15</b>



**Yasargil**

 Ø 3 mm 22 cm/8¾" <b>RU 4064-22/01</b>	 Ø 5 mm 22 cm/8¾" <b>RU 4064-22/02</b>	 Ø 7 mm 24 cm/9½" <b>RU 4064-24/03</b>
 Ø 3 mm 22 cm/8¾" <b>RU 4064-22/04</b>	 Ø 3 mm 22 cm/8¾" <b>RU 4064-22/05</b>	 Ø 5 mm 22 cm/8¾" <b>RU 4064-22/06</b>
	 Ø 5 mm 22 cm/8¾" <b>RU 4064-22/07</b>	



**MIKRO-PINZETTEN  
MICRO FORCEPS**



12 cm/4 $\frac{3}{4}$ "  
gerade/straight  
**RU 4068-12**



12 cm/4 $\frac{3}{4}$ "  
gebogen/curved  
**RU 4069-12**



15 cm/6"  
gerade/straight  
**RU 4068-15**



15 cm/6"  
gebogen/curved  
**RU 4069-15**

**MIKRO-PINZETTEN, TUMORFASS-, ANATOMISCHE PINZETTEN**  
**MICRO FORCEPS, TUMOR GRASPING FORCEPS, DRESSING FORCEPS**



**Gerald**  
17,5 cm/7"  
**RU 4070-17 RU 4071-17**



**Lazar** **RU 4075-08**  
15,5 cm/6"

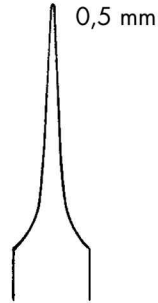

**RU 4075-05**

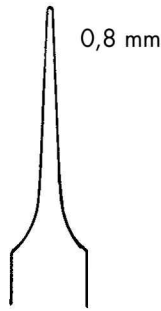

**RU 4075-08**

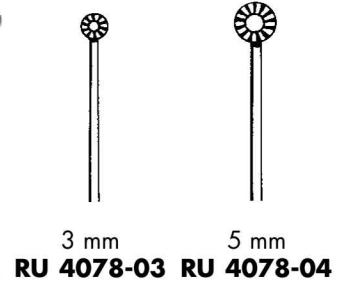

22 cm/8½"  
Maul flach, gezahnt  
Jaw flat, serrated

**Yasargil**



cm	in	<b>Potts-Smith</b>
18	7	<b>RU 4090-18</b>
21	8¼	<b>RU 4090-21</b>
25	10	<b>RU 4090-25</b>

cm	in	<b>Potts-Smith</b>
15	6	<b>RU 4092-15</b>
18	7	<b>RU 4092-18</b>
20	8	<b>RU 4092-20</b>
23	9	<b>RU 4092-23</b>
25	10	<b>RU 4092-25</b>

**Rudolf**  
Tc



**CHIRURGISCHE PINZETTEN**  
**TISSUE FORCEPS**

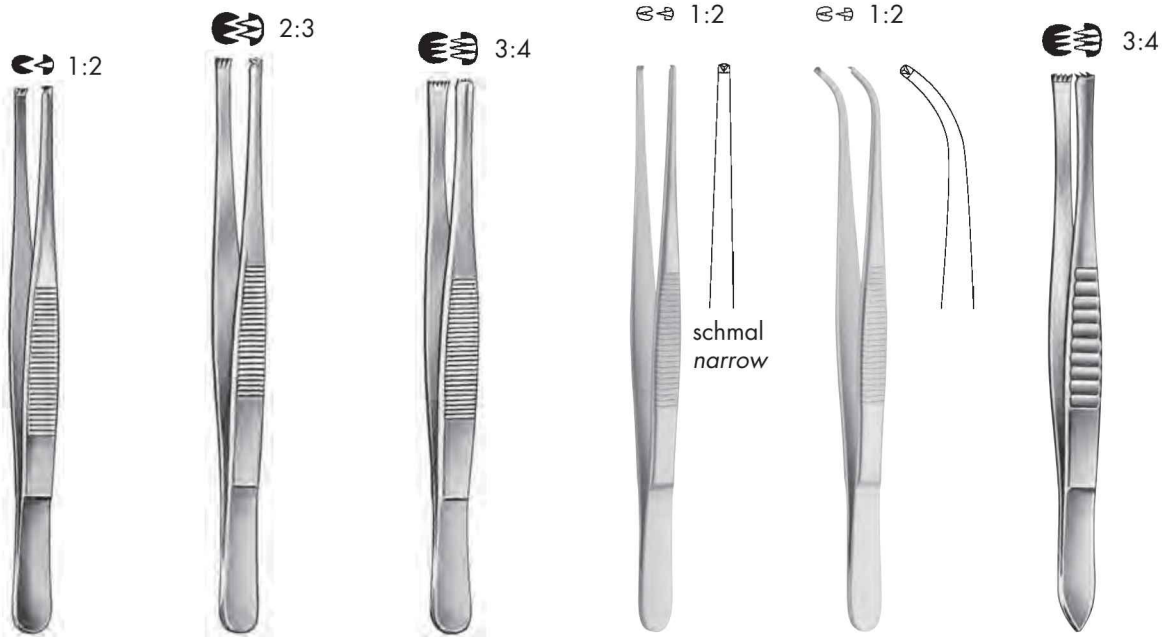

cm/in	Standard	Standard	Standard		Modell USA
10,5/4¼	<b>RU 4100-10</b>				
11,5/4½	<b>RU 4100-11</b>			<b>RU 4110-11</b>	
13,0/5	<b>RU 4100-13</b>	<b>RU 4102-13</b>		<b>RU 4110-13</b>	
14,5/5½	<b>RU 4100-14</b>	<b>RU 4102-14</b>		<b>RU 4110-14</b>	<b>RU 4111-1</b> <b>RU 4123-14</b>
15,0/6	<b>RU 4100-15</b>				
16,0/6¼	<b>RU 4100-16</b>	<b>RU 4102-16</b>	<b>RU 4103-16</b>	<b>RU 4110-16</b>	
18,0/7	<b>RU 4100-18</b>	<b>RU 4102-18</b>		<b>RU 4110-18</b>	
20,0/8	<b>RU 4100-20</b>	<b>RU 4102-20</b>	<b>RU 4103-20</b>	<b>RU 4110-20</b>	
25,0/10	<b>RU 4100-25</b>	<b>RU 4102-25</b>		<b>RU 4110-25</b>	

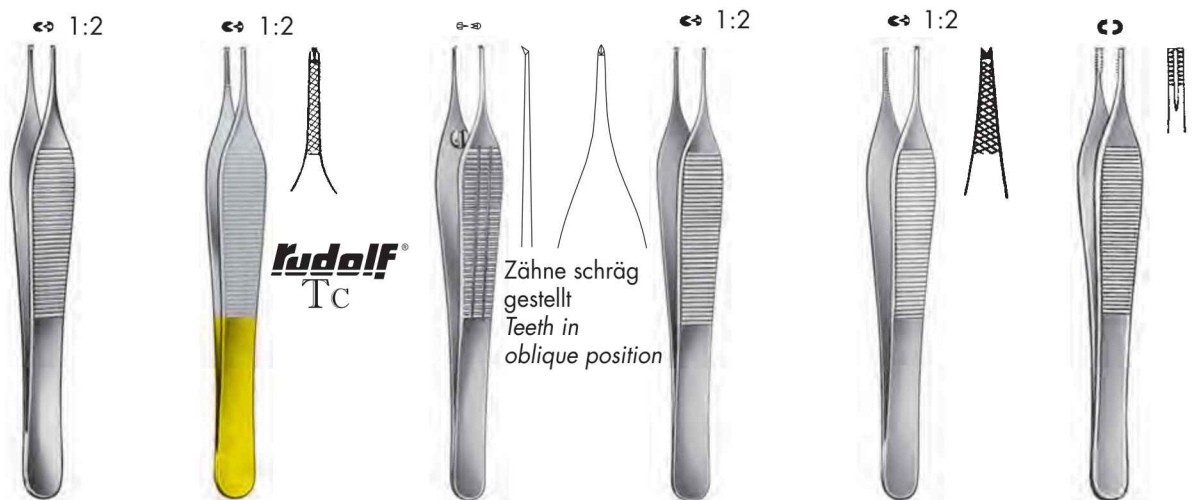

cm/in	Micro-Adson			Adson-Standard	Adson	Adson-Brown
12/4¾	<b>RU 4130-12</b>	<b>RU 4130-00/12</b>	<b>RU 4131-12</b>	<b>RU 4135-12</b>	<b>RU 4136-12</b>	<b>RU 4137-12</b>
15,5/6	<b>RU 4130-15</b>	<b>RU 4130-00/15</b>		<b>RU 4135-15</b>		<b>RU 4137-15</b>

**CHIRURGISCHE PINZETTEN  
TISSUE FORCEPS**

↔ 1:2



**McIndoe**  
15 cm/6"  
RU 4138-15/01

↔ 1:2



**Gillies**  
15 cm/6"  
RU 4138-15

↔ 1:2



cm/in	<b>Semken</b>
12/4 <sup>3</sup> / <sub>4</sub>	<b>RU 4140-12</b>
15/6	<b>RU 4140-15</b>

↔ 2:3



	<b>Semken</b>
	<b>RU 4142-12</b>
	<b>RU 4142-15</b>



	<b>Derlacki</b>
	<b>RU 4143-12</b>



cm/in	<b>Marschik</b>
15/6	
18/7	
20/8	
22/8 <sup>3</sup> / <sub>4</sub>	<b>RU 4146-22</b>
30/12	



	<b>Waugh</b>
	<b>RU 4155-15</b>
	<b>RU 4155-18</b>
	<b>RU 4155-20</b>
	<b>RU 4155-25</b>
	<b>RU 4155-30</b>



	<b>Gerald</b>
	<b>RU 4170-18</b>



	<b>Gerald</b>
	<b>RU 4171-18</b>

**UHRMACHERPINZETTEN, FEINE PINZETTEN  
WATCHMAKER'S FORCEPS, FINE FORCEPS**

0,3 mm



**No. 3**

11,5 cm/4½"  
**RU 4240-03**

0,2 mm



**No. 4**

11 cm/4½"  
**RU 4240-04**

0,15 mm



**No. 5**

11 cm/4½"  
**RU 4240-05**

0,3 mm



**No. 6**

11 cm/4½"  
**RU 4240-06**

0,2 mm



**No. 7**

11,5 cm/4½"  
**RU 4240-07**

↔ 1:2

0,4 mm



**No. 8**

11,5 cm/4½"  
**RU 4240-08**



cm/in

10,5/4¼

**RU 4250-10**

**RU 4251-10**

**RU 4260-10**

**RU 4261-10**

**SPLITTERPINZETTEN, ATRAUMATISCHE PINZETTEN  
SPLINTER FORCEPS, ATRAUMATIC TISSUE FORCEPS**

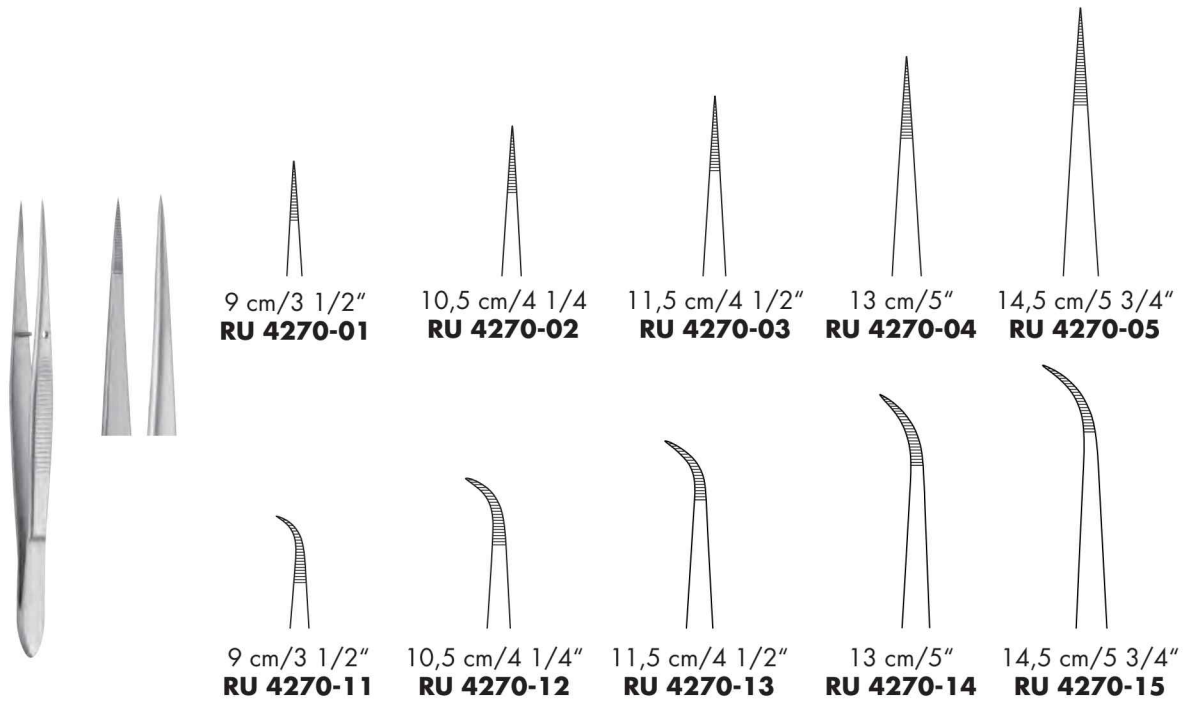

**Rudolf**<sup>®</sup>  
**DEBAKEY**



**De BaKEY**

Maulbreite width of jaw	1,5 mm	2,0 mm	2,7 mm
16 cm/6 1/4"	<b>RU 7580-16</b>	<b>RU 7581-16</b>	<b>RU 7582-16</b>
20 cm/ 8"	<b>RU 7580-20</b>	<b>RU 7581-20</b>	<b>RU 7582-20</b>



**De BaKEY**

2,0 mm	<b>RU 7584-16</b>
	<b>RU 7584-20</b>



**ATRAUMATISCHE-, OHR- UND NASENPINZETTEN, BULLDOGKLEMMEN  
ATRAUMATIC FORCEPS AND BULLDOG CLAMPS, AURAL AND NASAL FORCEPS**

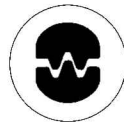

**Rudolf**<sup>®</sup>  
DeBAKEY



**Adson**

**RU 7585-12** 12 cm/4¾"  
**RU 7585-15** 15 cm/6"



**RU 7586-07** 8 cm/3"  
**RU 7586-08** 9 cm/3½"



**RU 7587-07**  
**RU 7587-08**



1 mm

cm	in	Troeltsch (Wilde)	Troeltsch	Lucae	Lucae (Fine)	Lucae	Cottle
11	4½	<b>RU 7860-11</b>					
12	4¾	<b>RU 7860-12</b>	<b>RU 7861-12</b>				
14	5½			<b>RU 7862-14</b>	<b>RU 7862-14/1</b>	<b>RU 7863-14</b>	
15	6	<b>RU 7860-15</b>					<b>RU 7863-15</b>
18	7	<b>RU 7860-18</b>					



**NASEN-, COLUMELLA- UND CHIRURGISCHE PINZETTEN**  
**NASAL FORCEPS, COLUMELLA FORCEPS, TISSUE FORCEPS**

2,2 mm



1 mm



2,2 mm



**Jansen  
(Gruenwald)**

**Jansen  
(Fine)**

**Jansen**

**Cottle**

16 cm/6¼"	<b>RU 7864-16</b>	<b>RU 7864-16/1</b>	<b>RU 7865-16</b>
18 cm/7"	<b>RU 7864-18</b>	<b>RU 7864-18/1</b>	
20 cm/8"	<b>RU 7864-20</b>	<b>RU 7864-20/1</b>	<b>RU 7865-20</b>

10 cm/4"  
**RU 8312-10**



**Graefe**  
11 cm/4½"

Zahnbreite 0,5 mm  
width of teeth



**Castroviejo**  
10 cm/4"  
**RU 9964-05**

ohne Schloß  
without spring catch

**RU 9942-11**

mit Schloß  
with spring catch

**RU 9943-11**

**WUND- UND NERVHÄKCHEN  
WOUND AND NERVE HOOKS**



**Cushing**  
19 cm/7½"



**RU 4426-01**



**RU 4426-02**



**Gillies**  
18 cm/7"  
**RU 6296-01**



**Gillies**  
18 cm/7"  
**RU 6296-02**



**Kilner**  
15 cm/6"  
**RU 6297-15**



**RU 6392-13**  
**RU 6392-18**



**RU 6393-13**  
**RU 6393-18**

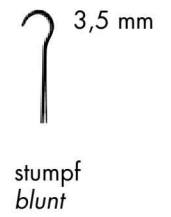

**WUND-, HAUT- UND TRACHEALHÄKCHEN  
WOUND AND TRACHEA HOOKS**

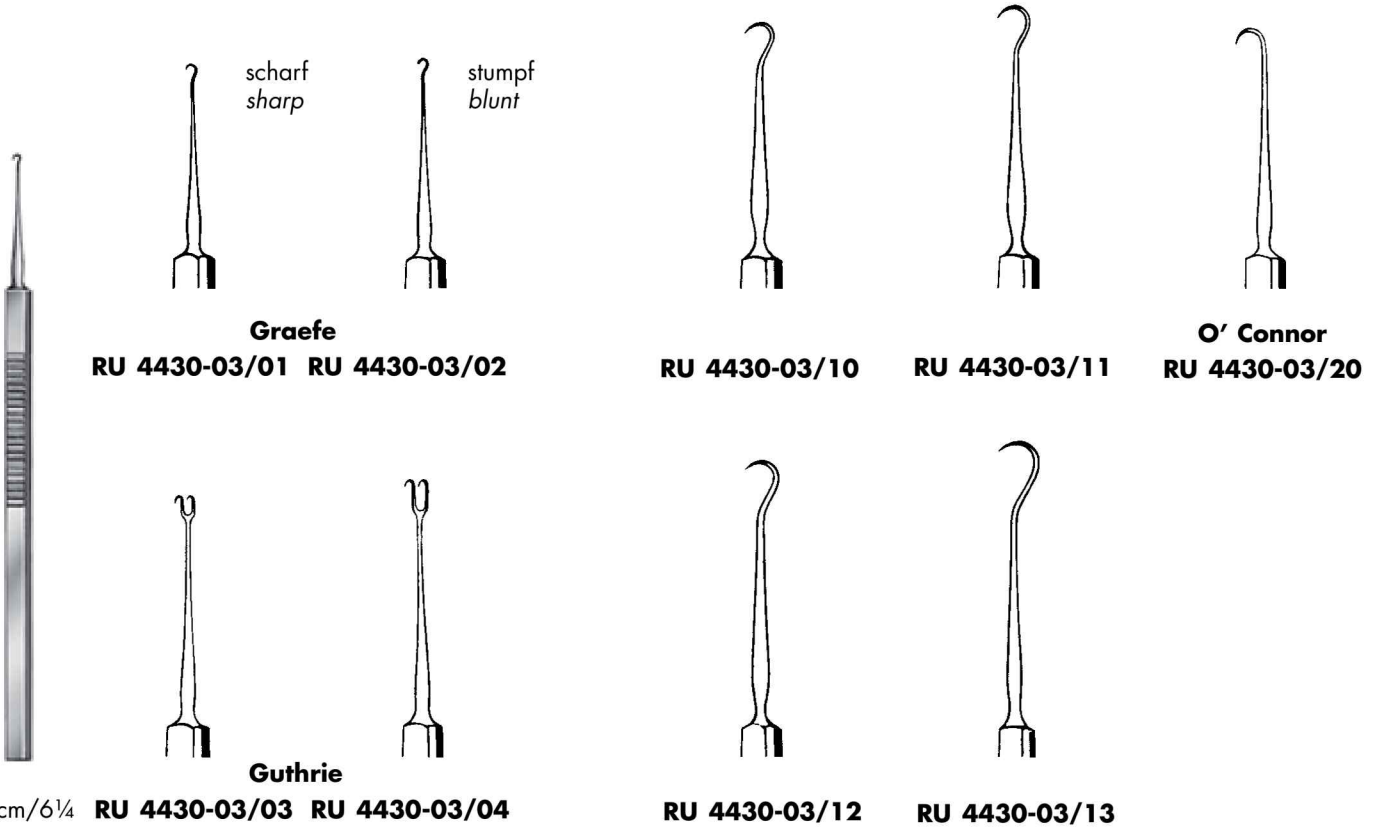

**WUND- UND TRACHEALHÄKCHEN  
WOUND AND TRACHEA HOOKS**



**Humby**  
11,5 cm/4½"  
RU 4437-00



**Lukens**  
17 cm/6¾"  
RU 4438-17



**Jackson**  
17 cm/6¾"  
RU 4439-17

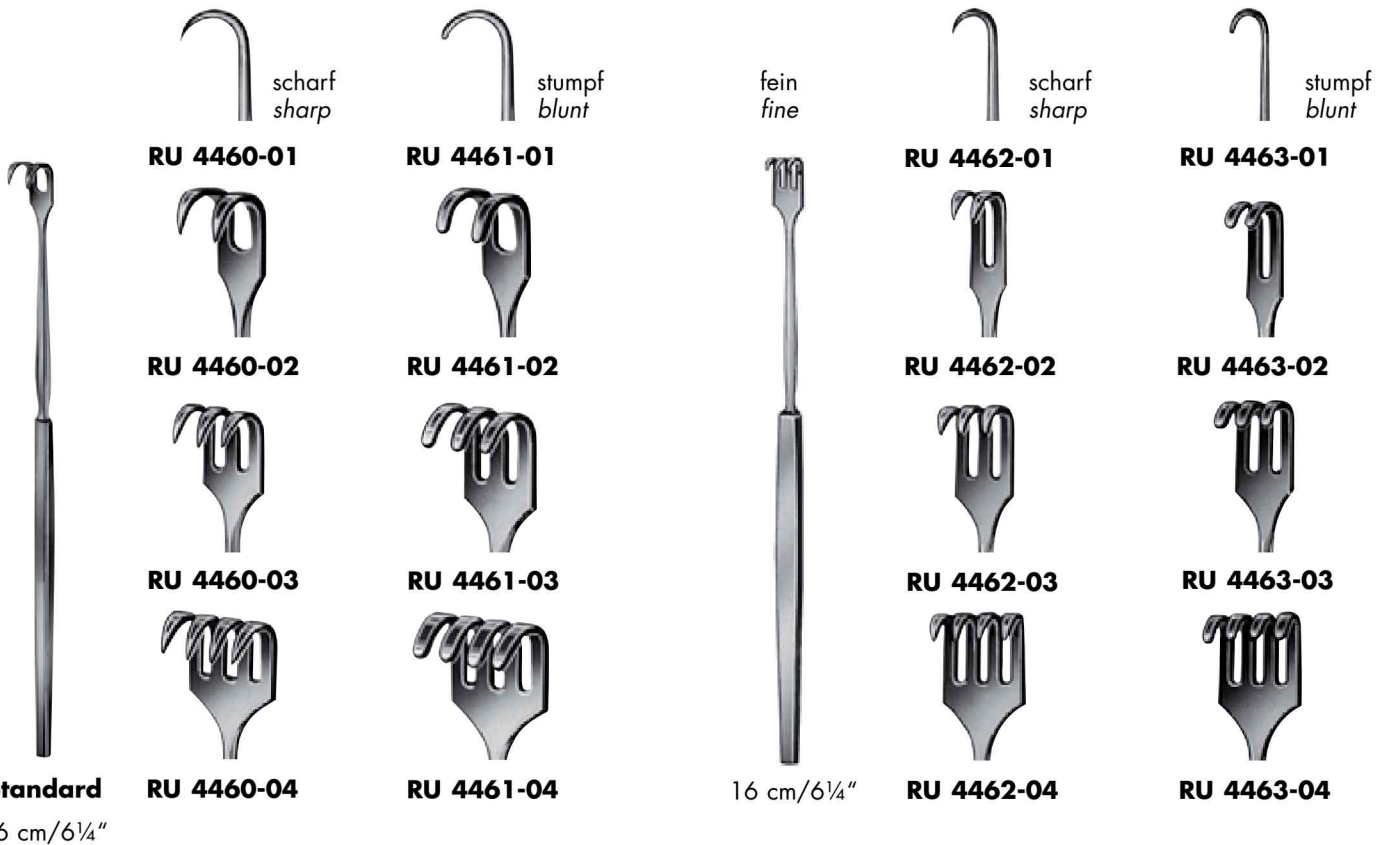

**WUND-, HAUT- UND TRACHEALHÄKCHEN  
WOUND AND TRACHEA HOOKS**

flexibel  
flexible



16 cm/6¼"



**RU 4464-01**

scharf  
sharp



**RU 4465-01**

stumpf  
blunt



**RU 4464-02**



**RU 4465-02**



**RU 4464-03**



**RU 4465-03**



**RU 4464-04**



**RU 4465-04**



**Jackson**  
13 cm/5"  
**RU 4468-13**



**Bergmann**  
14 cm/5½"  
**RU 4469-14**



**Meyerding**  
18 cm/7"



18 x 7 mm  
**RU 4470-01**



16 x 5 mm  
**RU 4470-02**



7 x 4 mm  
**RU 4470-03**



10 x 3 mm  
**RU 4470-04**



7 x 4 mm  
**RU 4470-05**



**RU 4471-01**



**RU 4471-02**

**Iterson**  
16 cm/6¼"

**TRACHEALHÄKCHEN, WUNDHAKEN  
TRACHEA HOOKS, RETRACTORS**



scharf  
sharp



stumpf  
blunt

**RU 4472-02**

**RU 4473-02**



**RU 4472-03**



**RU 4473-03**



**RU 4472-04**



**RU 4473-04**



**RU 4472-06**



**RU 4473-06**



**Volkmann**

11,5 cm/4½"

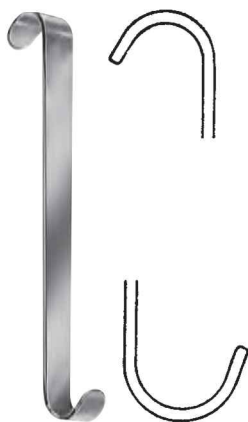

**Luer**

11 cm/4½"  
**RU 4479-11**



**Rose**

13 cm/5"  
**RU 4477-13**



scharf  
sharp

**RU 4486-01**

stumpf  
blunt

**RU 4486-02**

**Senn-Miller**

16 cm/6¼"

**WUNDHAKEN  
RETRACTORS**



**Ragnell-Davis**  
15 cm/6"  
**RU 4488-14**



**Langenbeck-Green**  
16 cm/6¼"



**RU 4490-01**



**RU 4490-02**



**RU 4490-03**



11 x 13 mm  
**RU 4490-13**



16 x 6 mm  
**RU 4490-16**



25 x 6 mm  
**RU 4490-25**



**Roux**

Satz/set			<b>RU 4492-00</b>
14 cm/5½"	Fig. 1	21x22 + 29x29 mm	<b>RU 4492-01</b>
15 cm/6"	Fig. 2	24x26 + 37x35 mm	<b>RU 4492-02</b>
17 cm/6¾"	Fig. 3	27x29 + 42x35 mm	<b>RU 4492-03</b>



**Baby-Roux**

13 cm/5"  
**RU 4492-13**



**WUNDHAKEN  
RETRACTORS**

30 x 19 mm



33 x 25 mm  
**Kilner**  
15 cm/6"  
**RU 4492-19**

35 x 29 mm



40 x 35 mm  
**Kilner**  
15 cm/6"  
**RU 4492-20**

30 x 18 mm



25 x 10 mm  
**Hajek**  
16,5 cm/6½"  
**RU 4492-21**



Satz  
set

**Farabeuf**  
12 cm/4¾"  
**RU 4497-12**



Satz  
set

**Farabeuf**  
15 cm/6"  
**RU 4497-15**

**WUNDHAKEN  
RETRACTORS**



**Volkman**  
22 cm/8¾"  
**RU 4500-01**

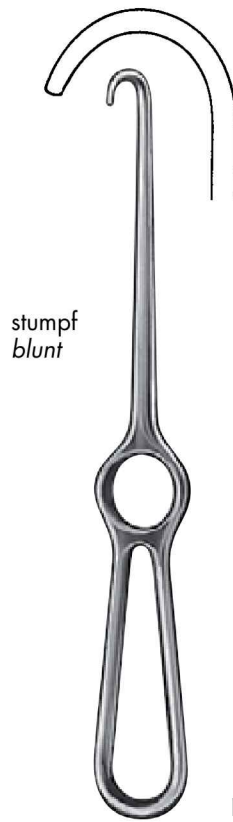

**Volkman**  
22 cm/8¾"  
**RU 4501-01**



scharf  
sharp

stumpf  
blunt

halbscharf  
semi-sharp

**Volkman**  
22 cm/8¾"

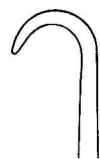
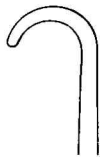

9 x 8 mm

9 x 13 mm

9 x 19 mm

9 x 29 mm

9 x 40 mm



**RU 4500-02**

**RU 4500-03**

**RU 4500-04**

**RU 4500-06**

**RU 4500-08**



**RU 4501-02**

**RU 4501-03**

**RU 4501-04**

**RU 4501-06**

**RU 4501-08**



**RU 4502-02**

**RU 4502-03**

**RU 4502-04**

**RU 4502-06**

**RU 4502-08**

**WUNDHAKEN  
RETRACTORS**



scharf  
sharp

**Kocher**

21,5 cm/8½"  
**RU 4506-11**



stumpf  
blunt

**Kocher**

21,5 cm/8½"  
**RU 4507-11**

30 x 12 mm



**Glanz**

21 cm/8¼"  
**RU 4511-21**

36 x 30 mm  
**RU 4510-03**



**Ollier**

22,5 cm/9"



36 x 55 mm  
**RU 4510-04**



55 x 20 mm  
**RU 4522-01**

63 x 20 mm  
**RU 4522-02**

60 x 20 mm  
**RU 4522-05**

**Langenbeck**  
21 cm/8¼"



35 x 7 mm  
**RU 4523-01**

35 x 10 mm  
**RU 4523-02**

35 x 15 mm  
**RU 4523-03**

60 x 20 mm  
**RU 4523-04**

**Langenbeck**  
21 cm/8¼"

**WUNDHAKEN  
RETRACTORS**



**Langenbeck**

21 cm/8¼"

<b>RU 4530-01</b>	30 x 11 mm
<b>RU 4530-02</b>	30 x 14 mm
<b>RU 4530-03</b>	33 x 14 mm
<b>RU 4530-04</b>	30 x 16 mm
<b>RU 4530-05</b>	40 x 11 mm
<b>RU 4530-06</b>	42 x 13 mm
<b>RU 4530-07</b>	50 x 11 mm



**Langenbeck**

22 cm/8¾"

<b>RU 4531-01</b>	
<b>RU 4531-05</b>	
<b>RU 4531-06</b>	



**Kocher**

19 cm/7½"

19 x 12 mm	
<b>RU 4536-01</b>	
21 x 15 mm	
<b>RU 4536-02</b>	

**Kocher-Langenbeck**

21,5 cm/8½"

25 x 6 mm	<b>RU 4538-11</b>
25 x 8 mm	<b>RU 4538-12</b>
35 x 8 mm	<b>RU 4538-13</b>
35 x 11 mm	<b>RU 4538-14</b>
35 x 15 mm	<b>RU 4538-15</b>
40 x 11 mm	<b>RU 4538-16</b>
55 x 11 mm	<b>RU 4538-17</b>
70 x 14 mm	<b>RU 4538-18</b>
80 x 12 mm	<b>RU 4538-19</b>
80 x 16 mm	<b>RU 4538-20</b>



**Middeldorpf**



14 x 17 mm  
21,5 cm/8½"  
**RU 4551-01**



20 x 22 mm  
22 cm/8¾"  
**RU 4551-02**



26 x 30 mm  
23,5 cm/9¼"  
**RU 4551-03**

**WUNDSPERRER  
RETRACTORS**



**Finsen**

cm/in	scharf/sharp	stumpf/blunt	scharf/sharp
5 cm/2"	<b>RU 4640-05</b>	<b>RU 4641-05</b>	
7 cm/2¾"	<b>RU 4640-07</b>	<b>RU 4641-07</b>	<b>RU 4642-07</b>

**Allport**

9,5 cm/3¾"  
**RU 4645-09**



**Alm**

cm/in	scharf/sharp	stumpf/blunt
7 cm/2¾"	<b>RU 4650-07</b>	<b>RU 4651-07</b>
10 cm/4"	<b>RU 4650-10</b>	<b>RU 4651-10</b>

10 cm/4"

scharf/sharp      stumpf/blunt  
**RU 4655-01/10**   **RU 4655-10**

**Jansen**

10,5 cm/4¼"  
scharf/sharp      stumpf/blunt  
**RU 4680-10**      **RU 4681-10**

**WUNDSPERRER, KIEFERHÖHLENSPERRER  
RETRACTORS, ANTRUM RETRACTORS**

**Kieferhöhlensperrerr  
Antrum retractor**



rechtes Blatt voll,  
scharf gezahnt  
solid blade right  
coarse serrated



**Perkins**  
13 cm/5"  
**RU 4688-01**



linkes Blatt voll,  
scharf gezahnt  
solid blade left  
coarse serrated



**Perkins**  
13 cm/5"  
**RU 4688-02**

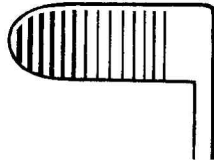

**Plester**  
11 cm/4½"  
**RU 4690-01**



**Plester**  
11 cm/4½"  
**RU 4690-02**

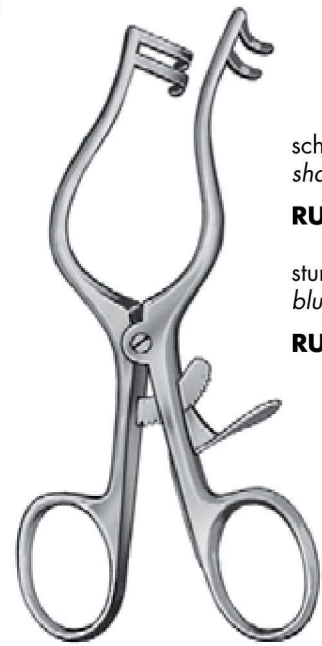

**Plester**  
13 cm/5"

scharf  
sharp  
**RU 4691-01**

stumpf  
blunt  
**RU 4691-02**



**KIEFERHÖHLENSPERRER, WUNDSPERRER  
ANTRUM RETRACTORS, RETRACTORS**

verstellbar/adjustable



17 cm/6¾"

Blatt/blade  
25 x 17 mm **RU 4694-05**  
35 x 17 mm **RU 4694-07**



17 cm/6¾"

**RU 4694-06**  
**RU 4694-08**



**Fisch**  
17 cm/6¾"  
**RU 4694-11**



**Fisch**  
17 cm/6¾"  
**RU 4694-13 B**



**Weitlaner**

scharf      stumpf  
sharp      blunt

10,5 cm/4¼" **RU 4700-10 RU 4701-10**



**Weitlaner**

scharf      stumpf  
sharp      blunt

**RU 4700-13 RU 4701-13**

**RU 4700-16 RU 4701-16**



**Weitlaner-Wullstein**

scharf      stumpf  
sharp      blunt

**RU 4710-13 RU 4711-13**

**RU 4710-16 RU 4711-16**

13 cm/5"

16,5 cm/6½"

**WUNDSPERRER  
RETRACTORS**



**Bellucci**  
13 cm/5"  
**RU 4713-13**



**Mollison**  
15 cm/6"  
**RU 4714-15**



**Henley**  
16,5 cm/6½"  
scharf/sharp stumpf/blunt  
**RU 4718-00 RU 4718-01**  
komplett mit 3 Mittelvalven  
complete with 3 central blades



16 x 19 mm  
**RU 4718-19**



16 x 25 mm  
**RU 4718-25**



16 x 32 mm  
**RU 4718-32**

Mittelvalven, allein  
Central blades, only

**WUNDSPERRER, WANGEN- UND LIPPENHALTER  
RETRACTORS, CHEEK AND LIP RETRACTOR**



**Weitlaner-Baby**  
13 cm/5"  
**RU 4719-13**



**Cone  
(Adson-Baby)**  
13 cm/5"  
verstellbar/adjustable  
scharf/sharp    stumpf/blunt  
**RU 4722-13    RU 4723-13**



19 cm/7½"  
**RU 8420-19**  
Wangen- und Lippenhalter  
Cheek and lip retractors

**SKALPELLGRIFFE  
SCALPEL HANDLES**



No. 3  
**RU 4850-03**



No. 4  
**RU 4850-04**



No. 7  
**RU 4850-07**



No. 8  
**RU 4850-08**



No. 9  
**RU 4850-09**

**SKALPELLGRIFFE  
SCALPEL HANDLES**



No. 3 L  
**RU 4850-31**



No. 4 L  
**RU 4850-41**



22,5 cm/9"  
**RU 4850-78**

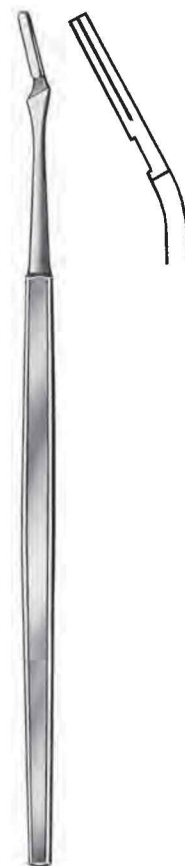

22,5 cm/9"  
**RU 4850-79**

**SKALPELLKLINGEN  
SCALPEL BLADES**

Packung à 100 Stk.  
Package of 100 pcs.



unsteril/ <i>non-sterile</i> steril/ <i>sterile</i>	Fig. 10	Fig. 11	Fig. 12	Fig. 13	Fig. 15
	<b>RU 4851-10</b> <b>RU 4852-10</b>	<b>RU 4851-11</b> <b>RU 4852-11</b>	<b>RU 4851-12</b> <b>RU 4852-12</b>	<b>RU 4851-13</b> <b>RU 4852-13</b>	<b>RU 4851-15</b> <b>RU 4852-15</b>

passend zu den Griffen/*for handles*: RU 4850-03, RU 4850-07, RU 4850-31

Packung à 100 Stk.  
Package of 100 pcs.



unsteril/ <i>non-sterile</i> steril/ <i>sterile</i>	Fig. 18	Fig. 19	Fig. 20	Fig. 21
	<b>RU 4851-18</b> <b>RU 4852-18</b>	<b>RU 4851-19</b> <b>RU 4852-19</b>	<b>RU 4851-20</b> <b>RU 4852-20</b>	<b>RU 4851-21</b> <b>RU 4852-21</b>

passend zu den Griffen/*for handles*: RU 4850-04, RU 4850-08, RU 4850-09, RU 4850-41

Packung à 100 Stk.  
Package of 100 pcs.



unsteril/ <i>non-sterile</i> steril/ <i>sterile</i>	Fig. 22	Fig. 23	Fig. 24	Fig. 25
	<b>RU 4851-22</b> <b>RU 4852-22</b>	<b>RU 4851-23</b> <b>RU 4852-23</b>	<b>RU 4851-24</b> <b>RU 4852-24</b>	<b>RU 4851-25</b> <b>RU 4852-25</b>

passend zu den Griffen/*for handles*: RU 4850-04, RU 4850-08, RU 4850-09, RU 4850-41



**MINI-KLINGEN, SKALPELLGRIFFE**  
**MINI BLADES, SCALPEL HANDLES**

Packung à 10 Stk.  
Package of 10 pcs.  
steril/sterile



Fig. 64  
**RU 4853-64**



Fig. 65  
**RU 4853-65**



Fig. 67  
**RU 4853-67**



Fig. 69  
**RU 4853-69**



13,5 cm/5½"  
**RU 4853-01**



15,5 cm/6"  
**RU 4853-02**



3 K  
10 cm/4" **RU 4853-03 K**  
13 cm/5" **RU 4853-13 K**  
15 cm/6" **RU 4853-15 K**

Griff für Mini-Skalpellklingen  
Handle for mini scalpel blades

**SKALPELLGRIFFE FÜR MINI-KLINGEN**  
**SCALPEL HANDLES FOR MINI BLADES**



**Caspar**  
18 cm/7"  
**RU 4854-03**



20 cm/8"  
**RU 4854-04**



**Landolt**  
21 cm/8¼"  
**RU 4854-10**



**Landolt**  
25 cm/10"  
**RU 4854-11**

**FISTELMESSER, RASIERKLINGEN UND -HALTER**  
**FISTULA KNIVES, RAZOR BLADES AND -HOLDERS**

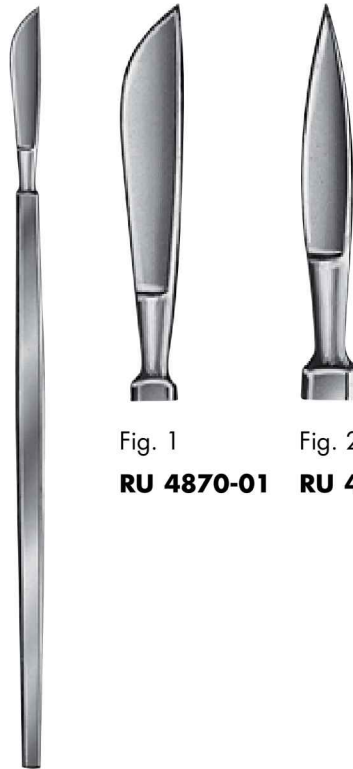

Fig. 1

**RU 4870-01**

Fig. 2

**RU 4870-02**

**Simon**  
20 cm/8"



**RU 4874-00**

Packung à 10 Klingen  
Package of 10 blades



**Castroviejo**  
Ø 8 mm  
13 cm/5"  
**RU 4878-13**

**SONDEN, PFLASTERSPATEL, WATTETRÄGER**  
**PROBES, PLASTER SPATULAS, COTTON APPLICATORS**



cm/in	1,0 mm Ø	1,5 mm Ø		
11,5/4½	<b>RU 4900-11</b>	<b>RU 4901-11</b>	<b>RU 4910-11</b>	
13,0/5	<b>RU 4900-13</b>	<b>RU 4901-13</b>	<b>RU 4910-13</b>	<b>RU 4914-13</b>
14,5/5¾	<b>RU 4900-14</b>	<b>RU 4901-14</b>	<b>RU 4910-14</b>	<b>RU 4914-14</b>

**Stacke**  
1,0 mm Ø  
10,5 cm/4¼"  
**RU 4916-10**

**Lange**  
18 cm/7"  
**RU 4919-01**

Pflasterspatel  
Plaster spatulas



13 cm/5"  
**RU 4920-13**



**Hartmann**  
22 cm/8½"  
**RU 4921-01**



**Pelteson**  
23 cm/9"  
**RU 4921-23**



**Fein**  
28 cm/11"  
**RU 4922-28**



**Killian**  
25 cm/10"  
**RU 4922-50**

**SONDEN UND DILATATOREN  
PROBES AND DILATORS**



**Seiffert**  
18 cm/7"  
Ø 0,5 mm  
**RU 4924-18**

Speichelgangsonde  
aus Silber  
Salival probe  
silver



**Killian**  
16,5 cm/6½"  
Ø 1,5 mm  
**RU 4927-01**



16 cm/6¼"  
Ø 1,4 mm  
**RU 4927-02**



**Siebenmann**  
18 cm/7"  
**RU 4928-18**



**Wilder**  
9,5 cm/3¾"  
**RU 9630-01**



**Wilder**  
9,5 cm/3¾"  
**RU 9630-02**



**Wilder**  
9,5 cm/3¾"  
**RU 9630-03**

Fig.	Bowman
0000/000	<b>RU 9651-00/3</b>
000/00	<b>RU 9651-00/2</b>
00/0	<b>RU 9651-00</b>
0/1	<b>RU 9651-01</b>
1/2	<b>RU 9651-12</b>
2/3	<b>RU 9651-23</b>
3/4	<b>RU 9651-34</b>
4/5	<b>RU 9651-45</b>
5/6	<b>RU 9651-56</b>
6/7	<b>RU 9651-67</b>
7/8	<b>RU 9651-78</b>



Fig.	Bowman
0000/000	<b>RU 9652-00/3</b>
000/00	<b>RU 9652-00/2</b>
00/0	<b>RU 9652-00</b>
0/1	<b>RU 9652-01</b>
1/2	<b>RU 9652-12</b>
2/3	<b>RU 9652-23</b>
3/4	<b>RU 9652-34</b>
4/5	<b>RU 9652-45</b>
5/6	<b>RU 9652-56</b>
6/7	<b>RU 9652-67</b>
7/8	<b>RU 9652-78</b>



Bitte Materialart angeben:  
Please add type of material:

**NS** Neusilber,  
**NS** German silver,

**SI** Silber  
**SI** silver

oder **NR** NR-Stahl  
or **NR** stainless steel

**WATTETRÄGER  
COTTON APPLICATORS**



**Universal**

cm	in	1,2 mm Ø	1,5 mm Ø	1,7 mm Ø
12,5	5"	<b>RU 4930-12</b>		<b>RU 4932-12</b>
16	6¼"	<b>RU 4930-16</b>		<b>RU 4932-16</b>
18	7"		<b>RU 4931-18</b>	<b>RU 4932-18</b>



**Jobson-Horne**  
18 cm/7"  
**RU 4933-02/18**



spiralförmig  
spiral threads

**Frohn**

cm	in	Ø 1,0 mm
12	4¾"	<b>RU 4934-01</b>
14	5½"	<b>RU 4934-02</b>
16	6¼"	<b>RU 4934-03</b>



**Frohn**

cm	in	Ø 1,0 mm
		<b>RU 4934-11</b>
		<b>RU 4934-12</b>
		<b>RU 4934-13</b>



**WATTETRÄGER, MESSINSTRUMENTE**  
**COTTON APPLICATORS, MEASURING INSTRUMENTS**



**Farell**  
**(Farell-Lathbury)**

rund  
round



dreikant  
triangular



**Mod. Rudolf**

rund  
round



dreikant  
triangular



cm/in				Ø 1,2 mm	Ø 1,5 mm	Ø 1,5 mm
12/4¾				<b>RU 4937-12</b>	<b>RU 4938-12</b>	<b>RU 4939-12</b>
14/5¾	Ø 0,9 mm	<b>RU 4935-14</b>	<b>RU 4936-14</b>	<b>RU 4937-14</b>	<b>RU 4938-14</b>	<b>RU 4939-14</b>
16/6¼	Ø 1,1 mm	<b>RU 4935-16</b>	<b>RU 4936-14</b>	<b>RU 4937-16</b>	<b>RU 4938-16</b>	<b>RU 4939-16</b>
18/7				<b>RU 4937-18</b>	<b>RU 4938-18</b>	<b>RU 4939-18</b>

graduiert mm: in  
graduated mm: in



10 cm/4"  
15 cm/6"  
20 cm/8"

**RU 5104-10**  
**RU 5104-15**  
**RU 5104-20**



**Townley**  
10 cm/4"  
**RU 5114-10**

**F. O. OTOSKOPE**  
**F. O. OTOSCOPE**

**HEINE BETA 200<sup>®</sup> F. O. Otokop**

Solide Ganzmetallkonstruktion mit Fiberglas-Beleuchtung. Großflächiges Sichtfenster. Gebläse-Anschluss. Xenon/Halogen-Beleuchtung. Völlig luftdichter Abschluss der kratzfesten Schwenklupe. Vergrößerung: ca. 3fach.

Distale Fiberoptik-Beleuchtung mit HEINE XHL<sup>®</sup>-Halogenlampe

- ▶ helle, schattenfreie Ausleuchtung ohne Reflexe



**HEINE BETA 200<sup>®</sup> F. O. Otoloscope**

Solid, all-metal construction. A quality instrument for the physician's office with fiber optics illumination. Large diameter viewing-window. Insufflation port. The swivel window features an airtight seal.

Distal fiber optics illumination with HEINE XHL<sup>®</sup> halogen bulb

- ▶ bright, shadow-free light without reflections

**F. O. Otokop**

**Otoloscope**  
2,5 V Halogen  
**RU 5126-10**

3,5 V Halogen  
**RU 5126-11**

**Ersatzlampe**

**Spare bulb**  
2,5 V Halogen  
**RU 5126-50**

3,5 V Halogen  
**RU 5126-51**



Ø 2,4 mm

**RU 5126-36**  
schwarz/black



Ø 3,0 mm

**RU 5126-37**



Ø 4,0 mm

**RU 5126-38**



Ø 5,0 mm

**RU 5126-39**

1 Satz Dauergebrauchstrichter (4 Stk.)  
1 Set (4 pcs.), re-usable

**RU 5126-40**

Einweg-Trichter (grau) 1000er Karton  
Disposable tips (grey) 1000 in box  
für Kinder/for children 2,5 mm

**RU 5126-45**

für Erwachsene/for adults 4,0 mm

**RU 5126-46**



**Set komplett mit BETA 200<sup>®</sup> F. O. Otokop**

1 Satz Dauergebrauchstrichter, 10 Einmalgebrauchstrichter, Ersatzlampe, im Hartschalenetui mit:

**Set complete with BETA 200<sup>®</sup> F. O. otoscope**

1 set of re-usable tips, 10 disposable tips, spare bulb, in solid case with:

Satz/Set



Batteriegriff  
(ohne Batterien)  
Battery handle  
(without batteries)  
2,5 V Halogen

**RU 5126-20**



Akkugriff  
Rechargeable handle  
3,5 V Halogen

**RU 5126-21**



Akkugriff  
mit Ladegerät, 3,5 V  
Rechargeable handle  
with charger, 3,5 V

**RU 5126-22**

**HEINE BETA 100<sup>®</sup> Diagnostik-Otoskop**

Ein neues Diagnostik-Otoskop mit direkter Xenon/Halogenbeleuchtung mit elegantem Ganzmetallgehäuse. Extrem vielseitig mit Anschluss für Nasenspekulum und Spreizspekulum für leichtes Instrumentieren. Das große Sichtfenster mit ca. 3x-Vergrößerung ist aus kratzfestem, optischem Glas. Das Kopfstück ist innen schwarz mattiert, um Reflexe zu eliminieren.

**HEINE BETA 100<sup>®</sup> Diagnostic-Otoscope**

*A new, all-metal otoscope with direct halogen illumination in an elegant all-metal instrument head. Unusually versatile in combination with nasal- and spreadable specula for easy instrumentation. Large diameter viewing window with ca. 3 x magnification, made of resistant optical glass. The instrument head is mat black inside to eliminate reflections.*

**Beta 100<sup>®</sup> Otoskop Ersatzlampe**  
**Otoscope Spare bulb**

2,5 V Halogen  
**RU 5127-10**

2,5 V Halogen  
**RU 5127-50**

3,5 V Halogen  
**RU 5127-11**

3,5 V Halogen  
**RU 5127-51**



Ø 2,2 mm

**RU 5127-34**



Ø 2,8 mm

**RU 5127-35**



Ø 3,5 mm

**RU 5127-36**



Ø 4,5 mm

**RU 5127-37**



Ø 5,5 mm

**RU 5127-38**



Ø 10,0 mm

**RU 5127-39**

1 Satz Dauergebrauchs-Trichter (6 St.) 5 Ohrtrichter, 1 Nasentrichter  
*1 Set re-usable tips (6 pcs.) 5 ear specula, 1 nose spec.*

**RU 5127-40**

Einweg-Trichter (grau) 1000er Karton  
*Disposable tips (grey) 1000 in box*

**RU 5127-45**

für Kinder/*for children* 2,5 mm

**RU 5127-46**

für Erwachsene/*for adults* 4,0 mm



**Set komplett mit BETA 100<sup>®</sup> Diagnostik-Otoskop**

1 Satz Dauergebrauchstrichter, 10 Einmalgebrauchstrichter, Ersatzlampe, im Hartschalenetui mit:

**Set complete with BETA 100<sup>®</sup> Diagnostic otoscope**

*1 set of re-usable tips, 10 disposable tips, spare bulb, in solid case with:*

Satz/Set



Batteriegriff  
(ohne Batterien)  
*Battery handle*  
(without batteries)  
2,5 V Halogen

**RU 5127-20**



Akkugriff  
*Rechargeable handle*  
3,5 V Halogen

**RU 5127-21**



Akkugriff  
mit Ladegerät, 3,5 V  
*Rechargeable handle*  
with charger, 3,5 V

**RU 5127-22**

## STROMQUELLEN, KOMBINIERTE DIAGNOSTIK-SETS POWER SUPPLIES, COMBINED DIAGNOSTIC SETS

Der BETA® R 3,5 V Griff wird, nach Abschrauben der Schutzkappe, direkt in der Steckdose aufgeladen.

*The BETA® R 3.5 V handle can be charged directly in the main socket or outlet after unscrewing the cap.*

Vollautomatische Ladung mit Überladeschutz. Zwei Griffe können unabhängig voneinander in einem Ladegerät geladen werden.

*This handle/charger system features fully automatic charging with overcharge protection. Two handles can be independently charged in one charger.*



### HEINE BETA® Batteriegriff 2,5 V

Ø 145 x 30 mm

(ohne Batterien)

**Battery handle**

(without batteries)

**RU 5123-50**



### HEINE BETA® Akkugriff R 3,5 V

Ø 170 x 30 mm

**Rechargeable handle**

**RU 5123-55**

Ladebatterie 3,5 V

*Rechargeable battery 3.5 V*

**RU 5123-70**



### HEINE BETA® NT 3,5 V - Griff

Ø 145 x 30 mm

**Rechargeable handle**

**RU 5123-60**

dto. mit Ladegerät

*dto. with charger*

**RU 5123-63**



BETA 200® Ophthalmoskop, BETA 100® Diagnostik-Otoskop, 1 Satz Dauergebrauchstrichter, 10 Einmalgebrauchstrichter, gebogener Kehlkopfspiegel mit Zubehör, spreizbares Nasenspekulum, je 1 Ersatzlampe, im Reißverschluss-Betui:

*Set complete with BETA 200® ophthalmoscope, BETA 100® diagnostic otoscope, 1 Set of re-usable tips, 10 disposable tips, curved laryngeal mirror with accessories, spreadable nasal speculum, one spare bulb each, in zipper case:*

Set mit Batteriegriff, 2,5 V

(ohne Batterien)

*Set with battery handle 2.5 V*

(without batteries)

**RU 5128-20**

Set mit Akkugriff, 3,5 V

*Set with rechargeable*

*handle 3.5 V*

**RU 5128-21**

Set mit Akkugriff

und Ladegerät 3,5 V

*Set with rechargeable*

*handle and charger, 3.5 V*

**RU 5128-22**



BETA 200® Ophthalmoskop, BETA 200® F. O. Otoskop, 1 Satz Dauergebrauchstrichter, 10 Einmalgebrauchstrichter, je 1 Ersatzlampe, im Hartschalenetui:

*Set complete with BETA 200® ophthalmoscope, BETA 200® F. O. otoscope, 1 Set of re-usable tips. 10 disposable tips, one spare bulb each, in solid case:*

Set mit Batteriegriff, 2,5 V

(ohne Batterien)

*Set with battery handle 2.5 V*

(without batteries)

**RU 5128-40**

Set mit Akkugriff, 3,5 V

*Set with rechargeable*

*handle 3.5 V*

**RU 5128-41**

Set mit Akkugriff

und Ladegerät 3,5 V

*Set with rechargeable*

*handle and charger, 3.5 V*

**RU 5128-42**



**MINI-OTOSKOPE, 2,5 V HALOGEN**  
**MINI OTOSCOPE, 2.5 V HALOGEN**



**Heine Mini 2000 F. O. Otoskop**  
komplett mit 4 Dauergebrauchs-Trichter,  
RU 5126-36 bis RU 5126-39,  
10 Einmalgebrauchs-Trichter,  
je 5 Stück,  
2,5 mm RU 5126-45 und  
4,0 mm RU 5126-46  
Mini-Griff in Hartschalenetui.

**Heine Mini 2000 F. O. Otoscope**  
complete with 4 re-usable tips,  
RU 5126-36 to RU 5126-39,  
10 disposable tips,  
each 5 pcs.  
2.5 mm RU 5126-45 and  
4.0 mm RU 5126-46  
Mini handle in case

**Heine Mini 2000 Otoskop**  
wie oben, jedoch mit Mini-Otoskop

**Heine Mini 2000 F. O. Otoscope**  
as above but with mini-otoscope

	schwarz/black	blau/blue	grün/green
<b>F. O. Otoskop komplett</b> <b>F. O. Otoscope complete</b>	<b>RU 5130-02</b>	<b>RU 5130-03</b>	<b>RU 5130-04</b>
Otoskop-Kopf allein Otoscope only	<b>RU 5130-12</b>	<b>RU 5130-13</b>	<b>RU 5130-14</b>
Ersatzlampe/Spare bulb	<b>RU 5127-50</b>		
<b>Otoskop komplett</b> <b>Otoscope complete</b>	<b>RU 5130-22</b>	<b>RU 5130-23</b>	<b>RU 5130-24</b>
Otoskop-Kopf allein Otoscope only	<b>RU 5130-32</b>	<b>RU 5130-33</b>	<b>RU 5130-34</b>
Ersatzlampe/Spare bulb	<b>RU 5130-40</b>		
Mini-Batteriegriff Mini Battery handle only	<b>RU 5130-52</b>	<b>RU 5130-53</b>	<b>RU 5130-54</b>
Hartschalenetui solid case	<b>RU 5130-70</b>		

## LUPENBRILLE C 2.3 BINOCULAR LOUPE C 2.3

### Die ultraleichte Lupenbrille

Arbeitsabstand 340 mm oder 450 mm

Die leichte (46 g), kompakte und bequeme HEINE Lupenbrille C mit 2,3facher Vergrößerung bietet gute Voraussetzungen für präzises und sicheres Arbeiten.

HEINE-Qualität zu einem außergewöhnlich attraktiven Preis.

### The ultra-light binocular loupe

Working distance 340 mm or 450 mm

The light weight (46 g), compact and comfortable HEINE Binocular Loupe C offers a 2.3 x magnification and is the ideal tool for professionals, who want to achieve the best results.

HEINE quality at a bargain price.

Geringer Abstand der Optik vom Untersucherauge ergibt extrem großes Sichtfeld

*The optics are close to the examiner's eyes to give an exceptionally large field of view*

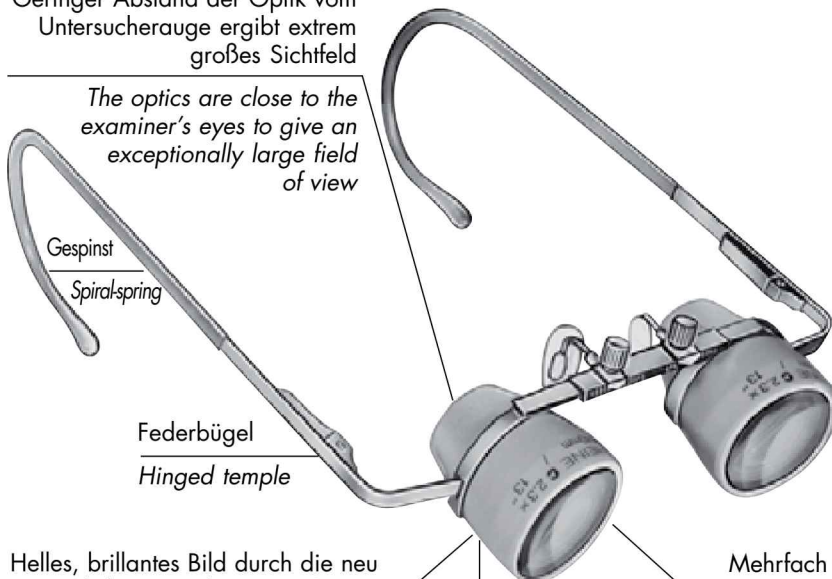

Helles, brillantes Bild durch die neu entwickelte C-Optik 2.3 x 340 mm

*Brilliant, high-resolution image with the new C optics 2.3 x 340 mm*

Mehrfach vergütete, hochwertige Optik, kratzfest

*Multi-coated, scratch-resistant silica glass lenses*

Die besonders kompakte Optik erlaubt es, an den Okularen vorbeizusehen, falls erwünscht

*Slimline optics – easy to view without magnification if required*

### Glasklares Sichtschutzvisier

Das Visier wird mit zwei Klammern direkt an der Brillenfassung befestigt.

### Clear protective visor

The visor is attached to the loupe frame by two simple clips

**RU 5145-70** (12er Pack)



### Aufsteckbare Schutzgläser (Paar)

**Detachable protective lenses**

**RU 5145-71**



### Brillenetui

**Protective case**

**RU 5145-72**



### Technische Daten/Specifications

	<b>RU 5145-34</b>	<b>RU 5145-45</b>
Vergrößerung/ <i>magnification</i>	2,3 x	2.3 x
Arbeitsabstand/ <i>working distance</i>	340 mm	450 mm
Sichtfeld/ <i>field of view</i>	ca. 110 mm	ca. 130 mm
Gewicht/ <i>weight</i>	46 g	46 g
PD Einstellung/ <i>PD range</i>	50 bis/to 74 mm	
<b>Dioptrie/<i>dioptry</i></b>	<b>Arbeitsabstand/<i>working distance</i></b>	
+ 2	440 mm	670 mm
+ 1	390 mm	560 mm
0	340 mm	450 mm
- 1	300 mm	420 mm
- 2	270 mm	370 mm



## STIRNSPIEGEL HEAD MIRRORS



### Ziegler

mit schwarzem Plastikband  
*with black head band*

Ø 90 mm **RU 5150-09**

Ø 100 mm **RU 5150-10**

mit weißem Plastikband  
*with white head band*

Ø 90 mm **RU 5151-09**

Ø 100 mm **RU 5151-10**

Stirnband, allein  
*Head band only*

schwarz/*black*

**RU 5150-20**

weiß/*white*

**RU 5151-20**

Stirnspiegel, allein  
*Reflector only*

Ø 90 mm **RU 5152-09**



### Murphy

**RU 5150-25**

Stirnband aus Zelluloid, weiß, allein  
*Celluloid head band, white, only*

## CLAR STIRNLAMPEN CLAR HEADLIGHTS

### Clar

#### Stirnlampe

mit weißem Plastikstirnband  
*with white plastic head band*

**RU 5153-00**

mit Zelluloidstirnband  
*with celluloid head band*

**RU 5154-00**

Ersatzspiegel  
*Spare mirror*

**RU 5154-80**

Ersatz-Schaumgummipolsterung  
*Spare foam rubber pad*

**RU 5154-85**

Ersatz-Glühbirne  
*Spare bulb*

**RU 5154-90**



### Clar

#### Stirnlampe Clar F 55

Ergonomischer, gepolsterter Stirnreif; Lichtfokussierung per Drehknopf; leicht wechselbarer Spiegel; 2 m teilbares Kabel mit Bananensteckern, Spiegel Ø 55 mm, 6 Volt

#### Headlight Clar F 55

*Ergonomic headband with foam at the inside; adjustable light beam by control knob; easily replaceable mirror; 2 m divisible cord with banana plugs, mirror Ø 55 mm, 6 Volt*

**RU 5155-00**

Ersatzspiegel  
*Spare mirror*

**RU 5155-05**

Ersatz-Schaumgummipolsterung  
*Spare foam rubber pad*

**RU 5154-85**

Ersatz-Glühbirne  
*Spare bulb*

**RU 5155-99**



Daten zum Trafo entnehmen Sie bitte Seite 124  
*For transformer please refer to page 124*

## CLAR STIRNLAMPEN, KALTLICHT-STIRNLAMPEN CLAR HEADLIGHTS, FIBER OPTIC HEADLIGHTS

### Clar

#### **Stirnlampe Clar S, 55 mm**

Reflektorhohlspiegel Ø 55 mm; verstellbarer ergonomischer Stirnreif; 2m Zuleitung, Bananenstecker, 6 Volt

#### **Headlight Clar S, 55 mm**

Concave mirror Ø 55 mm; adjustable ergonomic headband; 2m cord with banana plugs, 6 Volt

#### **RU 5155-10**

Ersatzspiegel  
Spare mirror

#### **RU 5155-15**

Ersatz-Glühbirne  
Spare bulb

#### **RU 5155-99**

Daten zum Trafo entnehmen Sie bitte Seite 124  
For transformer please refer to page 124



### Clar

#### **Kaltlicht Stirnlampe Clar 73**

Klassische HNO-Stirnlampe mit kleinem Spiegelreflektor. Untere Spiegelausbuchtung zur optimalen, monokularen Sicht. Komplett mit 2300 mm ultraleichtem F/O-Kabel und gepolstertem Stirnreif mit Kopfbügel und zentraler Schnellverstellung. Ohne Adapter für Lichtquelle.

#### **Fiber Optic Headlight Clar 73**

Classical ENT-headlight with small mirror. Lower hollow for optimal, monocular view. Complete with ultra light 2300 mm fiber optic light guide and easily adjustable leather bolstered headband with cross band. Without fitting for light source.

#### **RU 5155-20**

In der hitzefesten Variante können diese Stirnleuchten aber auch mit Hochleistungslichtquellen 180 Watt Xenon und 300 Watt Xenon benutzt werden.

Bitte angeben!

The heat resistant model offers the use with one of the high power xenon short arc light sources like 180 W Xenon and 300 W Xenon.

Please inform us!



## STIRNLAMPEN HEADLIGHTS

### Stirnlampe nach Jansen

Verstellbare Optik zur Lichtfokussierung; verstellbarer ergonomischer Stirnreif; 2m Zuleitung, Bananenstecker, 6 Volt.

### Headlight by Jansen

Adjustable lens tube for centering the light beam; Adjustable ergonomic headband; 2 m cord, banana plugs, 6 Volt.

#### RU 5157-10

Ersatz-Glühbirne  
Spare bulb

#### RU 5155-99

Daten zum Trafo entnehmen Sie bitte Seite 124  
For transformer please refer to page 124



### Xenon kabellose Stirnlampe mit Batteriebox

Helle Stirnlampe mit 6000° K Hochleistungslampe; optimiertes, parabolisches, optisches System mit Fixfocus; Hochleistungs-Miniatur-Xenon-Glühlampe mit integriertem Reflektor; höchste Mobilität durch integrierte Batteriebox für 2 Mignonzellen (AA).

Der schlanke, einstellbare Leuchtenkörper sorgt für ungehinderte Sicht; ergonomischer Stirnreif mit schwarzem Lederpolster.

### Xenon cords headlight with battery box

Very bright Xenon headlight with high power optical system and fixfocus. Special miniature Xenon incandescent reflector lamp (6000° K), optimised lightspot, mobile use with integrated battery box for 2 AA cells.

The slim lamp body results in an obstacle free view. Ergonomic adjustable headband with black leather bolster.

**RU 5157-20** Xenon Stirnlampe mit Batteriebox und 2 x 1,5 V Mignon-Zellen

Xenon headlight with battery box and 2 x 1,5 V batteries, size A 4

**RU 5157-21** Ersatzlampe mit Reflektor  
Spare lamp with reflector





## KALTLICHT-STIRNLAMPEN FIBER OPTIC HEADLIGHTS

### RU 5158-10 Miniatur-Stirnleuchte

Stirnleuchte mit hoher Lichtleistung zur intensiven Tiefenausleuchtung. Durch kleinen Lichtaustritt und verstellbare Kleinoptik optimales Sichtfeld.

Komplett mit 2200 mm rechtsseitig montiertem F/O-Kabel (Faserbündel-Ø 2,2 mm) und ledergepolstertem Stirnreif. Ohne Adapter für Lichtquelle.

#### **Miniature headlight**

*High light capacity miniature headlight for intensive depth illumination. Very small adjustable optic. Variable light beam. Complete with 2200 mm long F/O light guide is mounted on right side of ergonomic and leather bolstered headband. Without adapter for light source.*

**RU 5158-11** Wie 5158-10, jedoch 90° abgewinkeltes Kabelende.  
*Same as 5158-10 but cable end 90° angled.*

**RU 5158-20** OP-Version der Miniaturstirnleuchte. Der Faserbündelquerschnitt von 3,5 mm und das 2-fach Linsensystem sorgen für einen kleinen und homogenen Lichtfleck. Ohne Adapter für Lichtquelle.

*Operation theatre version of miniature headlight. The fiber bundle-Ø of 3.5 mm as well as the double lens system effect a small and homogenous light spot. Without fitting.*

**RU 5158-21** Wie 5158-20, jedoch 90° abgewinkeltes Kabelende.  
*Same as 5128-20 but cable end 90° angled.*



**RU 5158-11  
RU 5158-21**

In der hitzefesten Variante können diese Stirnleuchten aber auch mit Hochleistungslichtquellen 180 Watt Xenon und 300 Watt Xenon benutzt werden.

Bitte angeben!

*The heat resistant model offers the use with one of the high power xenon short arc light sources like 180 W Xenon and 300 W Xenon.*

*Please inform us!*

### RU 5158-40 Miniatur-Stirnleuchte mit Kopfbügelstirnband

Fiberoptische Miniaturstirnleuchte für den OP-Bereich. Maximales Sichtfeld durch Miniatur-Hochleistungs-Optik. Der Faserbündelquerschnitt von 3.5 mm und die verstellbare Kleinoptik mit 2-fachem Linsensystem gewährleisten einen sehr hellen und homogenen Lichtfleck. Das ledergepolsterte Stirnband mit Kopfbügel und zentraler Einhandverstellung sorgt für bequemen Sitz, auch über längere Zeit. Ohne Adapter für Lichtquelle.

#### **Miniature headlight with cross band headband**

*Fiber optic miniature headlight for operation theatre. Perfect view because of very small optic. The fiber bundle Ø of 3.5 mm as well as the double lens system effect a small and homogenous light spot. The leather bolstered headband with cross band is adjustable by one hand. It is comfortable also during long period of use. Without fitting for light source.*

**RU 5158-41** Wie 5158-40, jedoch 90° abgewinkeltes Kabelende.

*Same as 5158-40 but cable end 90° angled.*



**RU 5158-41**

## SPANNUNGSQUELLEN POWER SOURCES

### Steckernetzteil

- RU 5161-01** Spannungsausgang umschaltbar 4 V/6 V,  
max. 1000 mA, 2x Bananenbuchse
- RU 5161-02** Kabel-Zwischenschalter

### Wall plug transformer

- RU 5161-01** Output voltages switchable 4 V/6 V,  
max. 1000 mA, 2x banana plug
- RU 5161-02** Cord switch



**RU 5161-01**

**RU 5161-02**

### Batteriebox

Batteriebox 6 V für 4 Stk. Babyzelle-Batterien (Typ C),  
mit Cinch-Buchse und Schnurschalter.  
Spannung kann mit Batterieatrappe auf 4,5 V (1 Stück  
RU 5161-05) und 3 V (2 Stück RU 5161-05) gesenkt werden.  
Maße: 150 x 80 x 45 mm (L x B x H)

- RU 5161-03** Batteriebox 6 V
- RU 5161-04** Adapter, Bananen-Buchsen auf Cinch-Stecker
- RU 5161-05** Batterieatrappe



**RU 5161-03**



**RU 5161-04**



**RU 5161-05**

### Battery box

Battery box 6 V for 4 batteries type C,  
with cinch socket and cord switch.  
Voltage can be reduced to 4.5 V (1 pice RU 5161-05) or 3 V  
(2 pice RU 5161-05).  
Measures: 150 x 80 x 45 mm (L x W x H)

- RU 5161-03** Battery box 6 V
- RU 5161-04** Adapter, Banana sockets to cinch plug
- RU 5161-05** Battery dummy

### Tischtrafo

Regelbare Spannung von 0 bis 10 V, 2 A,  
Maße: 200 x 160 x 80 mm (L x B x H)

- RU 5161-20** Tischtrafo, 0-10 V

### Desk type light transformer

Adjustable voltage from 0 up to 10 V, 2 A  
Dimensions: 200 x 160 x 80 mm (L x W x H)

- RU 5161-20** Desk type transformer



Lichtquelle siehe Imaging-Katalog  
Light sources see Imaging-Catalogue

**TROKARE, SAUGKANÜLEN  
TROCARS, SUCTION TUBES**



**Krause**  
16 cm/6¼"  
Ø 5,5 mm  
**RU 5252-15**



**Coakley**  
16 cm/6¼"  
Ø 2,25 mm  
**RU 5253-16**



**Lichtwitz**

Ø mm	19 cm/7½"
1,8	<b>RU 5255-19</b>
2,0	<b>RU 5255-20</b>
2,3	<b>RU 5255-23</b>
2,7	<b>RU 5255-27</b>



**Pierce**

Ø mm	16 cm/6¼"
3,0	<b>RU 5258-30</b>
4,0	<b>RU 5258-40</b>
5,0	<b>RU 5258-50</b>



**Yankauer**  
27 cm/10½"  
**RU 5260-27**  
Saugkanüle  
Suction tube



**KANÜLEN  
CANNULAS**



**RU 5283-01**  
Kehlkopfkanüle  
*Laryngeal needle*



Ø 0,8 mm  
**RU 5283-05**



Ø 0,8 mm  
**RU 5283-06**



Ø 0,8 mm  
**RU 5283-07**

Septumkanülen/Septum needles



Ø 0,8 mm  
**RU 5283-09**  
Tonsillkanüle  
*Tonsil needle*



Luer-Lock  
Ø 0,8 mm  
**RU 8375-01**  
Septumkanüle  
*Septum needle*



**Pravaz**

0,9 x 38 mm	<b>RU-12131-01</b>
0,8 x 35 mm	<b>RU-12131-02</b>
0,7 x 32 mm	<b>RU-12131-03</b>
0,65 x 30 mm	<b>RU-12131-04</b>
0,6 x 25 mm	<b>RU-12131-05</b>
0,5 x 23 mm	<b>RU-12131-06</b>
0,45 x 18 mm	<b>RU-12131-07</b>

**SPRITZEN, FÜHRUNGSNADELN, REDON  
SYRINGES, GUIDE NEEDLES, REDON**

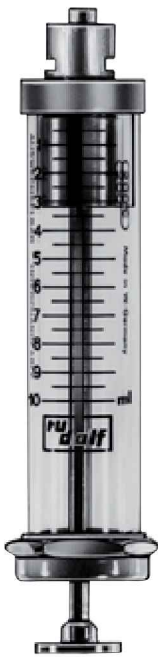

**Luer-Lock**

ml/cc	
1	<b>RU-12004-01</b>
2	<b>RU-12004-02</b>
5	<b>RU-12004-05</b>
10	<b>RU-12004-10</b>



**Luer-Lock**

ml/cc	Spritze Syringe	Zylinder Cylinder
2	<b>RU 5285-02</b>	<b>RU 5285-02/Z</b>
5	<b>RU 5285-05</b>	<b>RU 5285-05/Z</b>
10	<b>RU 5285-10</b>	<b>RU 5285-10/Z</b>

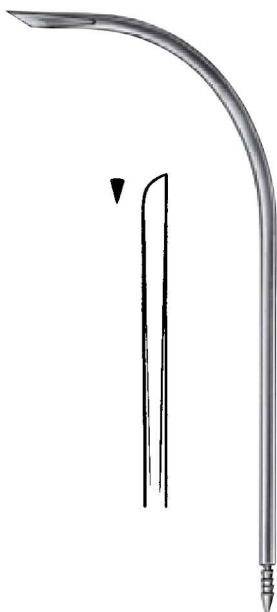

Charr/Fr.	
8	<b>RU 5291-28</b>
10	<b>RU 5291-30</b>
12	<b>RU 5291-32</b>
14	<b>RU 5291-34</b>



Charr/Fr.	
8	<b>RU 5291-48</b>
10	<b>RU 5291-50</b>
12	<b>RU 5291-52</b>
14	<b>RU 5291-54</b>

**KATHETERZANGEN  
CATHETER FORCEPS**



**Magill**

15 cm/6"  
für Kleinkinder/*for infants*  
**RU 5295-15**

20 cm/8"  
für Kinder/*for children*  
**RU 5295-20**

25 cm/10"  
für Erwachsene/*for adults*  
**RU 5295-25**

**FLACH- UND HOHLMEISSEL, OSTEOTOME  
BONE CHISELS, GOUGES, OSTEOTOMES**



Breite  
width  
mm

13,5 cm/5¼"

4	<b>RU 5300-04</b>	<b>RU 5302-04</b>	<b>RU 5304-04</b>
6	<b>RU 5300-06</b>	<b>RU 5302-06</b>	<b>RU 5304-06</b>
8	<b>RU 5300-08</b>	<b>RU 5302-08</b>	<b>RU 5304-08</b>
10	<b>RU 5300-10</b>	<b>RU 5302-10</b>	<b>RU 5304-10</b>
12	<b>RU 5300-12</b>	<b>RU 5302-12</b>	<b>RU 5304-12</b>
14	<b>RU 5300-14</b>	<b>RU 5302-14</b>	<b>RU 5304-14</b>
16	<b>RU 5300-16</b>	<b>RU 5302-16</b>	<b>RU 5304-16</b>

Osteotome  
Osteotome

Flachmeißel  
Bone chisels

Hohlmeißel  
Gouges

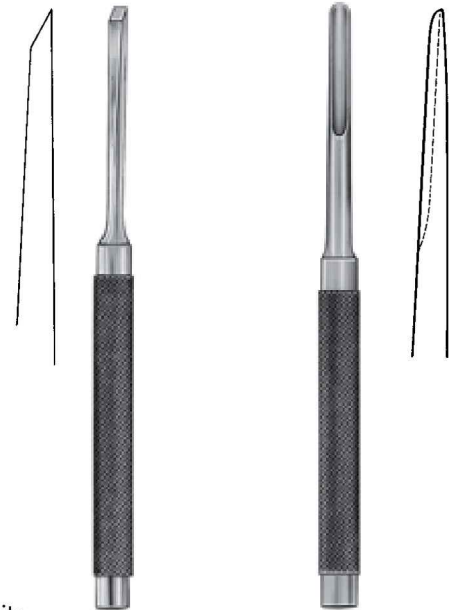

Breite  
width  
mm

**Lucas**  
16 cm/6¼"

3	<b>RU 5305-01/03</b>	<b>RU 5305-02/03</b>
4	<b>RU 5305-01/04</b>	<b>RU 5305-02/04</b>
5	<b>RU 5305-01/05</b>	<b>RU 5305-02/05</b>
6	<b>RU 5305-01/06</b>	<b>RU 5305-02/06</b>

Flachmeißel  
Bone chisels

Hohlmeißel  
Gouges

Breite  
width

mm

**Partsch**

13,5 cm/5¼"

**Partsch**

13,5 cm/5¼"

2	<b>RU 5308-02</b>	<b>RU 5314-02</b>
3	<b>RU 5308-03</b>	<b>RU 5314-03</b>
4	<b>RU 5308-04</b>	<b>RU 5314-04</b>
5	<b>RU 5308-05</b>	<b>RU 5314-05</b>
6	<b>RU 5308-06</b>	<b>RU 5314-06</b>
7	<b>RU 5308-07</b>	<b>RU 5314-07</b>
8	<b>RU 5308-08</b>	<b>RU 5314-08</b>

Flachmeißel  
Bone chisels

Hohlmeißel  
Gouges



Flachmeißel  
Bone chisels

Hohlmeißel  
Gouges



**STÖSSEL, OSTEOTOME, FLACH- UND HOHLMEISSEL  
PESTLES, OSTEOTOMES, BONE CHISELS AND GOUGES**



○ 3 mm  
**RU 5317-03**

○ 5 mm  
**RU 5317-05**

16 cm/6¼"  
Stößel  
Pestle



■ 2,5 mm  
**RU 5318-02**

■ 3,5 mm  
**RU 5318-03**

**Passow**  
12 cm/4¾"



mm  
2 **RU 5332-02**  
3 **RU 5332-03**  
4 **RU 5332-04**  
6 **RU 5332-06**  
8 **RU 5332-08**  
10 **RU 5332-10**  
12 **RU 5332-12**  
15 **RU 5332-15**

**Mini-Lambotte**  
12,5 cm/5"

Osteotome  
Osteotome



**Mini-Lexer**  
18 cm/7"

mm  
**RU 5334-04** 4 **RU 5335-04**  
**RU 5334-06** 6 **RU 5335-06**  
**RU 5334-08** 8 **RU 5335-08**  
**RU 5334-10** 10 **RU 5335-10**  
**RU 5334-12** 12 **RU 5335-12**

Osteotome  
Osteotome

Hohlmeißel  
Osteotome



**SCHARFE LÖFFEL  
BONE CURETTES**



**Volkmann**  
17 cm/6¾"

- |      |                   |
|------|-------------------|
| Fig. |                   |
| 0000 | <b>RU 5350-40</b> |
| 000  | <b>RU 5350-30</b> |
| 00   | <b>RU 5350-20</b> |
| 0    | <b>RU 5350-10</b> |
| 1    | <b>RU 5350-01</b> |
| 2    | <b>RU 5350-02</b> |
| 3    | <b>RU 5350-03</b> |
| 4    | <b>RU 5350-04</b> |
| 5    | <b>RU 5350-05</b> |
| 6    | <b>RU 5350-06</b> |

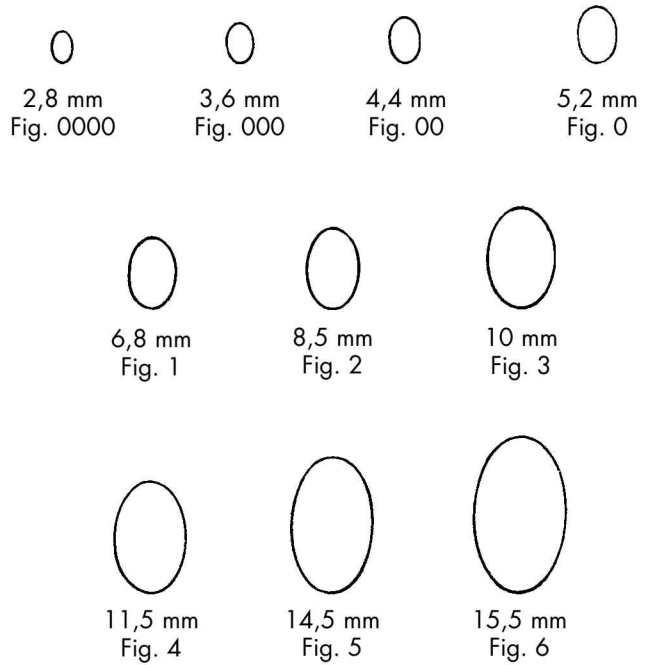

- |      |                   |
|------|-------------------|
| Fig. | <b>Spratt</b>     |
| 000  | <b>RU 5353-30</b> |
| 00   | <b>RU 5353-20</b> |
| 0    | <b>RU 5353-10</b> |
| 1    | <b>RU 5353-01</b> |
| 2    | <b>RU 5353-02</b> |
| 3    | <b>RU 5353-03</b> |
| 4    | <b>RU 5353-04</b> |
| 5    | <b>RU 5353-05</b> |
| 6    | <b>RU 5353-06</b> |



**Spratt**  
16 cm/6¼"

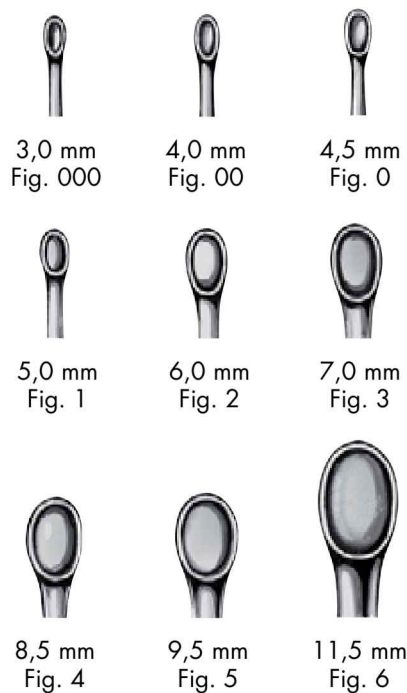

**Lempert**  
21,5 cm/8½"



**SCHARFE LÖFFEL  
BONE CURETTES**



**Uffenorde**  
17 cm/6¾"  
RU 5357-01



**Uffenorde**  
17 cm/6¾"  
RU 5357-02



**Martini**  
13,5cm/5"



**Jansen**  
16 cm/6¼"  
RU 5367-00/16



**Williger**  
13,5 cm/5"



**Barth-Preysing**  
19cm/7½"  
RU 5369-00/19



**Jacobson**  
13 cm/5"  
RU 5369-13



**RASPATORIEN  
PERIOSTEAL RASPATORIES**



**Molt**  
19 cm/7½"  
RU 5379-19

13 mm

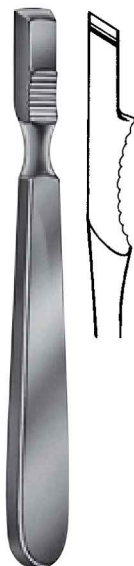

**Farabeuf**  
15 cm/6"  
RU 5380-15

13 mm



**Farabeuf**  
15 cm/6"  
RU 5381-15

15 mm



**Jansen**  
16,5 cm/6½"  
RU 5388-16

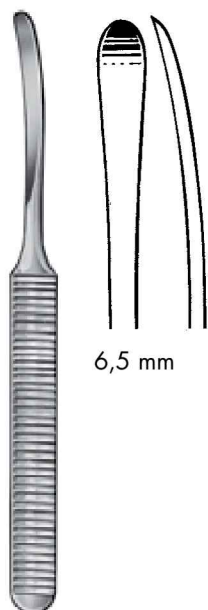

**Williger**  
16 cm/6¼"  
RU 5392-05 5 mm  
RU 5392-08 8 mm  
RU 5392-16 6,5 mm

6,5 mm



17 cm/6¾"

6 mm  
RU 5394-06

8 mm

RU 5394-08 RU 5399-00/16

4 mm



**Joseph**

16 cm/6¼"

RU 5399-00/16



**Lempert**

RU 7992-18

RU 7992-20

18 cm/7¼"

20,5 cm/8"

**RASPATORIEN, ELEVATORIEN  
PERIOSTEUM RASPATORIES, ELEVATORS**



19 cm/7½"  
**RU 5410-01**



18,5 cm/7¼"  
**RU 5410-02**



18,5 cm/7¼"  
**RU 5410-03**



18,5 cm/7¼"  
**RU 5410-04**



**Langenbeck**  
20 cm/8"  
**RU 5420-20**



**Williger**  
16 cm/6¼"  
**RU 5426-16**



**Quervain**  
20 cm/8"  
**RU 5427-20**

**ELEVATORIEN, HOHLMEISSELZANGEN**  
**ELEVATORS, BONE RONGEUR FORCEPS**

4,5 mm



**König**  
15 cm/6"  
RU 5431-01

4,5 mm

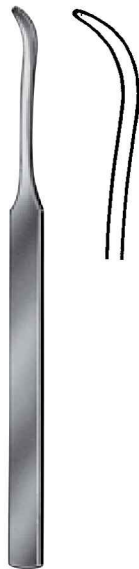

**König**  
15 cm/6"  
RU 5431-02



**McDonald**  
19 cm/7½"  
RU 5434-19

4 mm



**Sebileau**  
17 cm/6¾"  
RU 5436-17

6 mm



**Sewall**  
20 cm/8"  
RU 8335-20



**Bane-Hartmann**  
17,5 cm/7"  
RU 5559-17



**Friedmann**  
14 cm/5½"  
RU 5560-14



**Cleveland**  
14 cm/5½"  
RU 5562-14

**HOHLMEISSELZANGEN  
BONE RONGEUR FORCEPS**



**Mead**  
16,5 cm/6½"

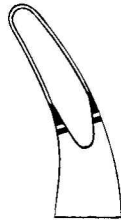

**RU 5566-16**



**RU 5568-16**



gerade  
straight

	cm	in
<b>RU 5570-16</b>	16	6¼
<b>RU 5570-19</b>	19	7½

**Lempert**

gebogen  
curved

<b>RU 5571-16</b>
<b>RU 5571-19</b>



**Beyer**  
18 cm/7"  
**RU 5572-18**



**Jansen**  
17,5 cm/7"



**RU 5573-17**



**RU 5574-17**



**Blumenthal**  
15,5 cm/6"



**RU 5575-01**



**RU 5575-02**

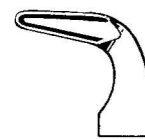

**RU 5575-03**

**HOHLMEISSELZANGEN  
BONE RONGEUR FORCEPS**



**Jansen**  
18 cm/7"  
**RU 5576-19**

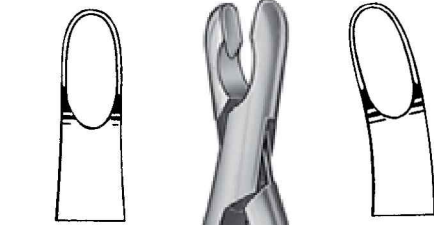

gerade  
straight  
**RU 5580-17**

gebogen  
curved  
**RU 5581-17**



**Luer**  
17 cm/6<sup>3</sup>/<sub>4</sub>"



**Luer**  
15 cm/6"

**RU 5582-15**

**RU 5583-15**

**RU 5584-15**



**Böhler**  
15 cm/6"



gerade/straight  
3 mm **RU 5588-15/1**  
4 mm **RU 5588-15**



gebogen/curved  
**RU 5588-15/1**  
**RU 5588-15**



**Zaufal-Jansen  
Beyer**  
18 cm/7"



4 mm  
**Zaufal-Jansen  
RU 5590-18**

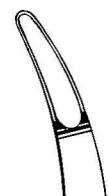

3 mm  
**Beyer  
RU 5592-18**

**HOHLMEISSELZANGEN, KNOCHENSPLITTERZANGEN, HÄMMER  
BONE RONGEUR FORCEPS, BONE CUTTING FORCEPS, MALLETS**

6 mm



**Ruskin**  
18 cm/7"  
gebogen/curved  
**RU 5594-18**



**Böhler**  
15 cm/6"



gerade  
straight

**RU 5700-15**



aufgebogen  
curved on flat

**RU 5701-15**



17 cm/6<sup>3</sup>/<sub>4</sub>"  
**RU 5703-17**



16 cm/6<sup>1</sup>/<sub>4</sub>"  
**RU 5759-16**

Drahtschneide- und Biegezange  
Wire cutting and bending pliers



Ø 30 mm, 215 g  
24,5 cm/9<sup>3</sup>/<sub>4</sub>"  
**RU 5798-24**

Ersatzbackenpaar  
Pair of spare jaws  
**RU 5798-51**

◀ mit auswechselbaren  
Kunststoffbacken  
with interchangeable  
plastic jaws ▶

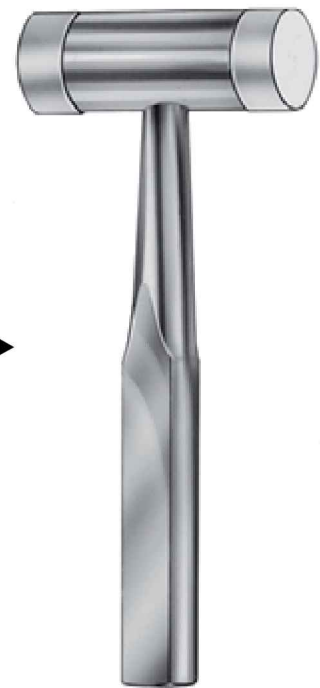

Ø 25 mm, 140 g  
18 cm/7"  
**RU 5799-18**

Ersatzbackenpaar  
Pair of spare jaws  
**RU 5799-51**



**HÄMMER  
MALLETS**



**Heermann**  
19,5 cm/7½"  
**RU 5807-19**



**Cottle**  
1 Seite flach  
1 Seite convex  
*1 side flat*  
*1 side convex*  
Ø 30 mm, 350 g  
19 cm/7½"  
**RU 5809-19**



**Williger**  
150 g  
23 cm/9½"  
bleigefüllt/lead filled  
**RU 5810-23**



**Hajek**  
Ø 27 mm, 140 g  
22 cm/8¾"  
**RU 5811-23**



Ø 22 mm, 165 g  
19 cm/7½"  
bleigefüllt/lead filled  
**RU 5812-19**



bleigefüllt  
lead filled  
**RU 5814-16**  
Messing massiv  
solid brass  
**RU 5815-16**

Ø 20 mm  
16,5 cm/6½"



**CHIRURGISCHE NADELN  
SURGICAL NEEDLES**

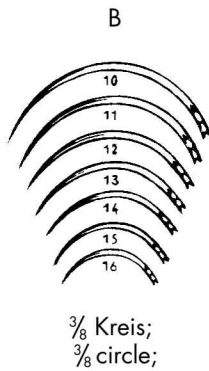

Fig.

10	<b>RU 5875-10</b>	<b>RU 5875-10 S</b>
11	<b>RU 5875-11</b>	<b>RU 5875-11 S</b>
12	<b>RU 5875-12</b>	<b>RU 5875-12 S</b>
13	<b>RU 5875-13</b>	<b>RU 5875-13 S</b>
14	<b>RU 5875-14</b>	<b>RU 5875-14 S</b>
15	<b>RU 5875-15</b>	<b>RU 5875-15 S</b>
16	<b>RU 5875-16</b>	<b>RU 5875-16 S</b>

▲  
Nadeln mit Dreikantschneide  
*triangular point*

gewöhnliches Ohr  
*regular eye*

Federöhr  
*spring eye*

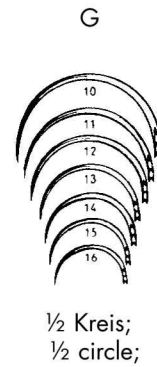

Fig.

10	<b>RU 5879-10</b>	<b>RU 5879-10 S</b>
11	<b>RU 5879-11</b>	<b>RU 5879-11 S</b>
12	<b>RU 5879-12</b>	<b>RU 5879-12 S</b>
13	<b>RU 5879-13</b>	<b>RU 5879-13 S</b>
14	<b>RU 5879-14</b>	<b>RU 5879-14 S</b>
15	<b>RU 5879-15</b>	<b>RU 5879-15 S</b>
16	<b>RU 5879-16</b>	<b>RU 5879-16 S</b>

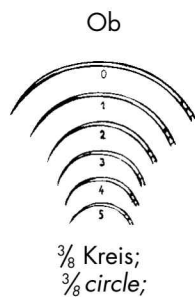

Fig.

0	<b>RU 5898-10</b>	<b>RU 5898-10 S</b>
1	<b>RU 5899-01</b>	<b>RU 5899-01 S</b>
2	<b>RU 5899-02</b>	<b>RU 5899-02 S</b>
3	<b>RU 5899-03</b>	<b>RU 5899-03 S</b>
4	<b>RU 5899-04</b>	<b>RU 5899-04 S</b>
5	<b>RU 5899-05</b>	<b>RU 5899-05 S</b>

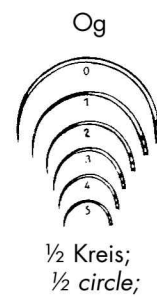

Fig.

0	<b>RU 5900-10</b>	<b>RU 5900-10 S</b>
1	<b>RU 5901-01</b>	<b>RU 5901-01 S</b>
2	<b>RU 5901-02</b>	<b>RU 5901-02 S</b>
3	<b>RU 5901-03</b>	<b>RU 5901-03 S</b>
4	<b>RU 5901-04</b>	<b>RU 5901-04 S</b>
5	<b>RU 5901-05</b>	<b>RU 5901-05 S</b>

**MIKRO-NADELHALTER  
MICRO NEEDLE HOLDERS**



gerade/straight gebogen/curved



mit Sperre/with ratchet  
gerade/straight gebogen/curved

12 cm/4 <sup>3</sup> / <sub>4</sub> "	<b>RU 5860-12</b>	<b>RU 5861-12</b>	<b>RU 5864-12</b>	<b>RU 5865-12</b>
15 cm/6"	<b>RU 5860-15</b>	<b>RU 5861-15</b>	<b>RU 5864-15</b>	<b>RU 5865-15</b>



**Barraquer**  
12 cm/4<sup>3</sup>/<sub>4</sub>"  
**RU 5973-12**

**NADELHALTER  
NEEDLE HOLDERS**



**Brown**  
13 cm/5"     **RU 5928-13**  
18 cm/7"     **RU 5928-18**



**Mayo-Hegar**  
schlankes Modell  
*delicate pattern*  
16 cm/6¼"     **RU 6003-16**  
18 cm/7"     **RU 6003-18**  
20 cm/8"     **RU 6003-20**



**Crile-Wood**  
15 cm/6"     **RU 6012-15**



**Senning**  
17 cm/6¾"     **RU 6017-17**  
schlank/*slim*

**NADELHALTER MIT HARTMETALLEINLAGEN**  
**NEEDLE HOLDERS WITH TUNGSTEN CARBIDE INSERTS**

**Rudolf**<sup>®</sup>  
Tc



**Neivert**  
13 cm/5"  
zwei Ringe abgewinkelt  
*two rings angled*  
**RU 6045-13**



16 cm/6¼" **RU 6050-16**  
18 cm/7" **RU 6050-18**  
20 cm/8" **RU 6050-20**

**Mayo-Hegar**



**Hegar-Baumgartner**  
14 cm/5½"  
**RU 6052-14**



**Mayo-Hegar**  
schweres Modell  
*heavy pattern*  
20 cm/8" **RU 6053-20**

**NADELHALTER MIT HARTMETALLEINLAGEN**  
**NEEDLE HOLDERS WITH TUNGSTEN CARBIDE INSERTS**



**Rudolf**  
Tc



**De Bakey**

18 cm/7"	<b>RU 6054-18</b>
20 cm/8"	<b>RU 6054-20</b>
23 cm/9"	<b>RU 6054-23</b>

**De Bakey**

16,5 cm/6½"	<b>RU 6054-40</b>
21 cm/8¼"	<b>RU 6054-41</b>



**Baby-Crile-Wood**

15 cm/6"  
**RU 6055-01**



**Crile-Wood**

15 cm/6"  
**RU 6055-15/1**



**Crile-Wood**

cm	in	
18	7	<b>RU 6055-18</b>
20	8	<b>RU 6055-20</b>

**NADELHALTER MIT HARTMETALLEINLAGEN  
NEEDLE HOLDERS WITH TUNGSTEN CARBIDE INSERTS**



**Halsey**  
13 cm/5"  
glatt/smooth



**Converse**  
12,5 cm/5"  
**RU 6057-12**



**Ryder**



**Micro-Ryder**



**Rudolf**  
(Swedish pattern)

13 cm/5"	<b>RU 6059-13</b>	<b>RU 6059-63</b>
15 cm/6"	<b>RU 6059-16</b>	<b>RU 6059-65</b>
18 cm/7"	<b>RU 6059-18</b>	<b>RU 6059-68</b>
20 cm/8"	<b>RU 6059-20</b>	<b>RU 6059-70</b>

15 cm/6"	<b>RU 6060-00/15</b>
17 cm/6¾"	<b>RU 6060-00/17</b>



**NADELHALTER MIT HARTMETALLEINLAGEN**  
**NEEDLE HOLDERS WITH TUNGSTEN CARBIDE INSERTS**



**Sarot**  
18 cm/7"  
**RU 6060-18**

**Rudolf**<sup>®</sup>  
Tc



**Mathieu**  
17 cm/6"  
20 cm/8"  
**RU 6066-17**  
**RU 6066-20**



**Langenbeck**  
20 cm/8"  
24 cm/9½"  
**RU 6067-50**  
**RU 6067-54**



**Lichtenberg**  
20 cm/8"  
**RU 6068-20**

**NADELHALTER MIT HARTMETALLEINLAGEN**  
**NEEDLE HOLDERS WITH TUNGSTEN CARBIDE INSERTS**

**Rudolf**<sup>®</sup>  
Tc



**Baby-Olsen-Hegar**  
11,5 cm/4½"  
**RU 6079-11**



**Olsen-Hegar**  
14 cm/5½"  
**RU 6080-14**



**Olsen-Hegar**  
17 cm/6¾"  
**RU 6080-17**

**UNTERBINDUNGSNADELN  
LIGATURE NEEDLES**



20 cm/8"  
links, für rechte Hand  
left, for right hand



**RU 6104-20**



scharf  
sharp



**RU 6106-20**



20 cm/8"  
rechts, für linke Hand  
right, for left hand

**Deschamps-Standard**



20 cm/8"  
links, für rechte Hand  
left, for right hand



**RU 6108-03**



scharf  
sharp



**RU 6108-04**



20 cm/8"  
rechts, für linke Hand  
right, for left hand

**Deschamps**

**UNTERBINDUNGSNADELN  
LIGATURE NEEDLES**

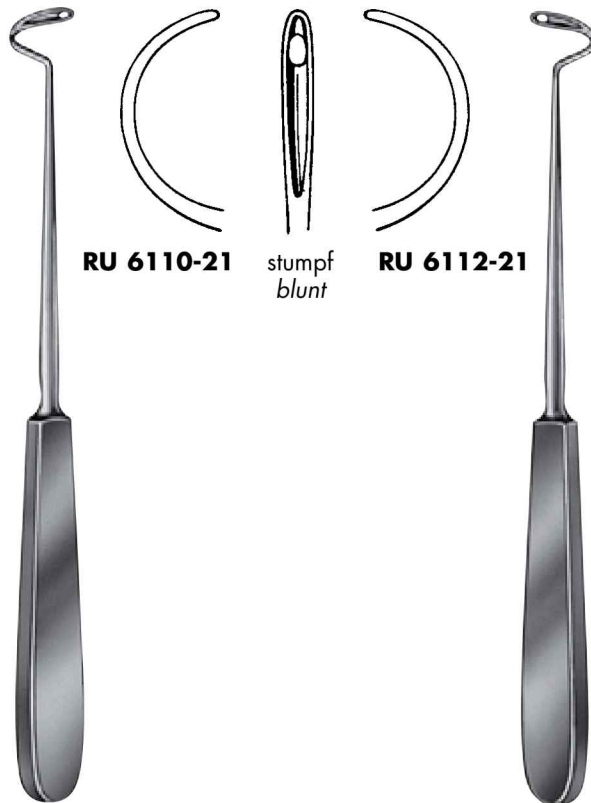

**RU 6110-21**

stumpf  
blunt

**RU 6112-21**

**Deschamps**

21 cm/8¼"  
links, für rechte Hand  
left, for right hand

21 cm/8¼"  
rechts, für linke Hand  
right, for left hand



**Kronecker**

13 cm/5"  
links, für rechte Hand    rechts, für linke Hand  
left, for right hand    right, for left hand  
**RU 6118-15**            **RU 6119-15**

**FÜHRUNGSHOHLSONDEN  
LIGATURE CONDUCTORS**



**König**  
19,5 cm/7¾"  
**RU 6141-19**



**König**  
19,5 cm/7¾"  
**RU 6142-19**



**König**  
20 cm/8"  
**RU 6143-20**

**ABSAUGROHRE  
SUCTION TUBES**



Ø 5 mm Charr./Fr. 15  
17 cm/6 ¾"  
**RU 6417-01**

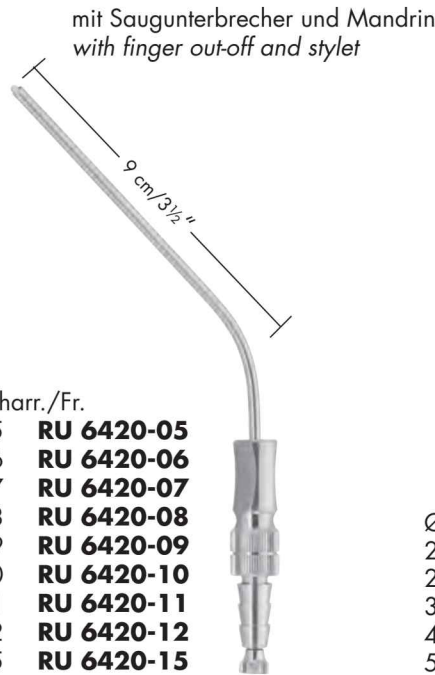

Ø mm	Charr./Fr.	Part Number
1,5	5	<b>RU 6420-05</b>
2,0	6	<b>RU 6420-06</b>
2,3	7	<b>RU 6420-07</b>
2,5	8	<b>RU 6420-08</b>
3,0	9	<b>RU 6420-09</b>
3,3	10	<b>RU 6420-10</b>
3,5	11	<b>RU 6420-11</b>
4,0	12	<b>RU 6420-12</b>
5,0	15	<b>RU 6420-15</b>

**Frazier  
(Fergusson)**

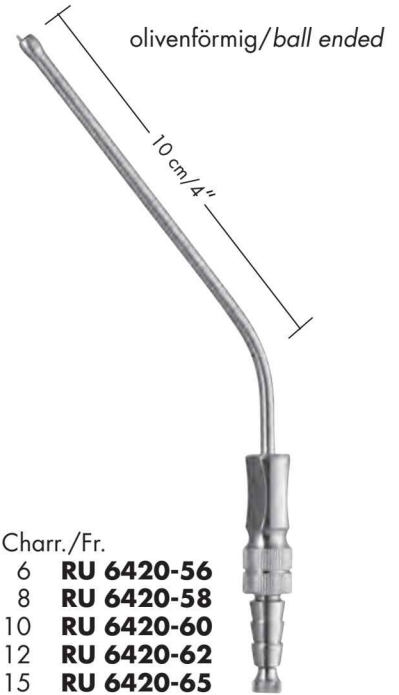

Ø mm	Charr./Fr.	Part Number
2,0	6	<b>RU 6420-56</b>
2,5	8	<b>RU 6420-58</b>
3,3	10	<b>RU 6420-60</b>
4,0	12	<b>RU 6420-62</b>
5,0	15	<b>RU 6420-65</b>

**Frazier**



Abstandsmarkierungen  
bei 5 – 9 cm  
Calibrations marked  
at 5 – 9 cm

Ø mm	Charr./Fr.	Part Number
2,0	6	<b>RU 6420-76</b>
2,5	8	<b>RU 6420-78</b>
3,3	10	<b>RU 6420-80</b>
4,0	12	<b>RU 6420-82</b>
5,0	15	<b>RU 6420-85</b>

**Frazier**



Ø mm	Charr./Fr.	Part Number
2,0	6	<b>RU 6421-06</b>
2,3	7	<b>RU 6421-07</b>
2,5	8	<b>RU 6421-08</b>
3,0	9	<b>RU 6421-09</b>
3,3	10	<b>RU 6421-10</b>
3,5	11	<b>RU 6421-11</b>
4,0	12	<b>RU 6421-12</b>
5,0	15	<b>RU 6421-15</b>

**Fergusson**

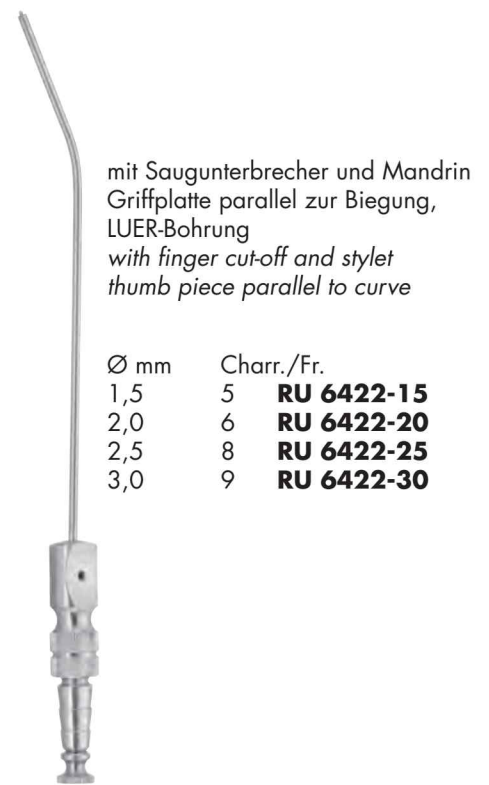

mit Saugunterbrecher und Mandrin  
Griffplatte parallel zur Biegung,  
LUER-Bohrung  
with finger cut-off and stylet  
thumb piece parallel to curve

Ø mm	Charr./Fr.	Part Number
1,5	5	<b>RU 6422-15</b>
2,0	6	<b>RU 6422-20</b>
2,5	8	<b>RU 6422-25</b>
3,0	9	<b>RU 6422-30</b>

**Plester**  
19,5 cm/7 ¾"



**MIKRO-ABSAUGROHRE, ABSAUGROHRE  
MICRO SUCTION TUBES, SUCTION TUBES**



Absaugrohr mit LUER-Bohrung  
Suction tube, with LUER hub

Saugset komplett  
Suction set complete

**RU 6423-50/00**

bestehend aus:  
consisting of:

- RU 6423-50/01**
- RU 6423-50/04**
- RU 6423-50/06**
- RU 6423-50/08**

**Wullstein**  
**RU 6423-50/01**



Mikro-Saugkanülen  
Micro suction cannulas

- 0,4 mm **RU 6423-50/04**
- 0,6 mm **RU 6423-50/06**
- 0,8 mm **RU 6423-50/08**



4 mm

20 cm/8"  
scharf/sharp  
**RU 6429-30**  
Saug-Raspatorium  
Suction Raspatory