

Naht, Verband, Tracheotomie, Dermatologie
Suture, Dressing, Tracheotomy, Dermatology
Sutura, Vendaje, Traqueotomía, Dermatología
Suture, Pansement, Trachéotomie, Dermatologie
Sutura, Bendaggi, Tracheotomia, Dermatologia

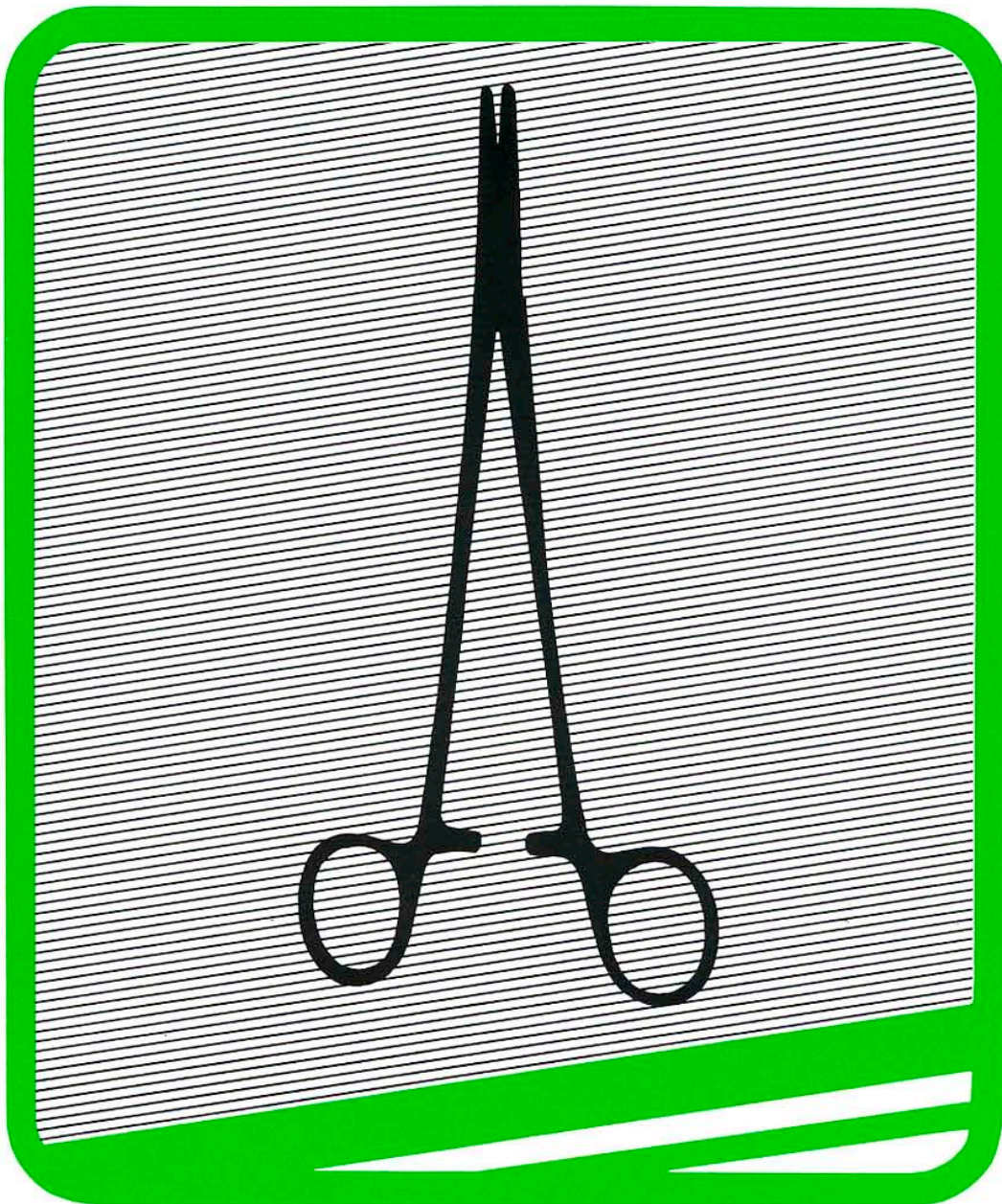

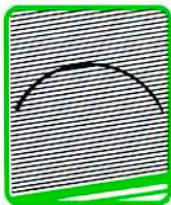

Chirurgische Nadeln
Surgical Needles
Suturas musculares y cutáneas
Aiguilles chirurgicales
Suture muscolari e cutanee



gewöhnliches Öhr
 regular eye
 ojo ordinario
 chas régulier
 cruna chiusa



Federöhr
 spring eye
 ojo de resorte
 chas à ressort
 cruna aperta



| | | | | |
|-------------|-------------|-----------|------------|-------------|
| gerade | straight | recto | droits | rette |
| halbgebogen | half curved | 1/2 curvo | 1/2 courbé | 1/2 curvi |
| 3/8 Kreis | 3/8 circle | 3/8 curvo | 3/8 cercle | 3/8 cerchio |
| 1/2 Kreis | 1/2 circle | 1/2 curvo | 1/2 cercle | 1/2 cerchio |
| 5/8 Kreis | 5/8 circle | 5/8 curvo | 5/8 cercle | 5/8 cerchio |



Nadeln mit Dreikantschneide
 triangular point
 punta triangular
 pointe triangulaire
 punte triangolare



runde Nadeln
 round point
 punta redonda
 pointe ronde
 punte rotonde



Nadeln mit Trokarspitze
 trocar point
 punta de trocar
 pointe de trocart
 punte trequarti

Verpackungsformen: Päckchen à 12 Stück, auf Wunsch auch in Großmengen.
 packaging: packets of 12 pieces; bigger unit-packs available on request.
 formas de embalaje: Paquetitos de 12 unidades, según deseo también en cantidades mayores.
 formes d'emballage: paquet de 12 pièces, sur demande également en grandes quantités.
 forma d'imballaggio: con 12 pezzi, a richiesta anche in quantità maggiori.

Die Abbildungen zeigen die natürliche Größe der Nadeln.
 The illustrations represent the natural size of the needles.
 Las ilustraciones representan el tamaño natural de las agujas.
 Les illustrations représentent la grandeur naturelle des aiguilles.
 Le illustrazioni rappresentano gli aghi a grandezza naturale.



Chirurgische Nadeln
 Surgical Needles
 Suturas musculares y cutáneas
 Aiguilles chirurgicales
 Suture muscolari e cutanee

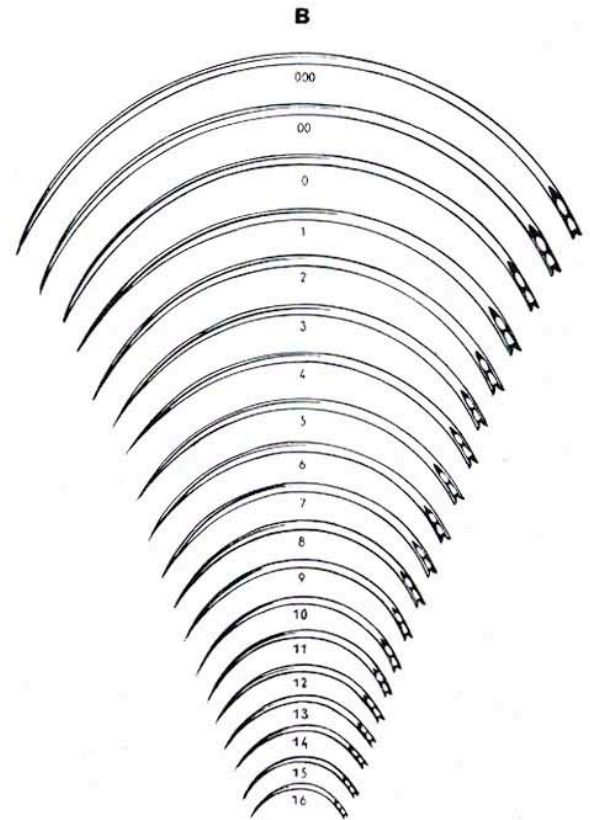
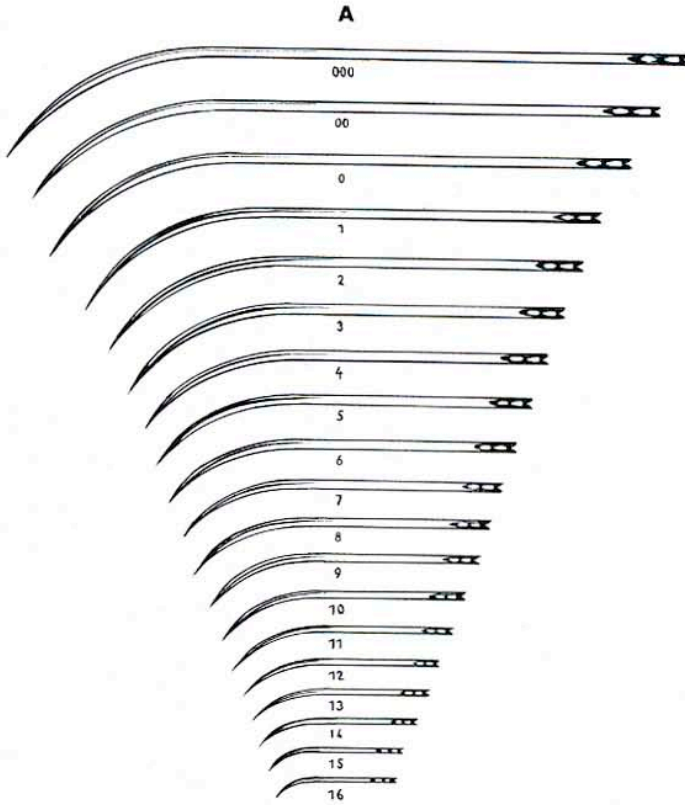
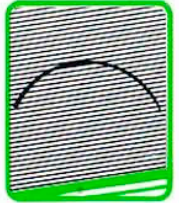

halb-gebogen; half curved; semi-curved; semi-courbes; semi curvi

$\frac{3}{8}$ Kreis; $\frac{3}{8}$ circle; $\frac{3}{8}$ circulo; $\frac{3}{8}$ cercle; $\frac{3}{8}$ cerchio



| Fig. | RU 5870-30 | RU 5870-30 S | RU 5872-30 | RU 5872-30 S | RU 5874-30 | RU 5874-30 S | RU 5876-30 | RU 5876-30 S |
|------|------------|--------------|------------|--------------|------------|--------------|------------|--------------|
| 000 | RU 5870-30 | RU 5870-30 S | RU 5872-30 | RU 5872-30 S | RU 5874-30 | RU 5874-30 S | RU 5876-30 | RU 5876-30 S |
| 00 | RU 5870-20 | RU 5870-20 S | RU 5872-20 | RU 5872-20 S | RU 5874-20 | RU 5874-20 S | RU 5876-20 | RU 5876-20 S |
| 0 | RU 5870-10 | RU 5870-10 S | RU 5872-10 | RU 5872-10 S | RU 5874-10 | RU 5874-10 S | RU 5876-10 | RU 5876-10 S |
| 1 | RU 5871-01 | RU 5871-01 S | RU 5873-01 | RU 5873-01 S | RU 5875-01 | RU 5875-01 S | RU 5877-01 | RU 5877-01 S |
| 2 | RU 5871-02 | RU 5871-02 S | RU 5873-02 | RU 5873-02 S | RU 5875-02 | RU 5875-02 S | RU 5877-02 | RU 5877-02 S |
| 3 | RU 5871-03 | RU 5871-03 S | RU 5873-03 | RU 5873-03 S | RU 5875-03 | RU 5875-03 S | RU 5877-03 | RU 5877-03 S |
| 4 | RU 5871-04 | RU 5871-04 S | RU 5873-04 | RU 5873-04 S | RU 5875-04 | RU 5875-04 S | RU 5877-04 | RU 5877-04 S |
| 5 | RU 5871-05 | RU 5871-05 S | RU 5873-05 | RU 5873-05 S | RU 5875-05 | RU 5875-05 S | RU 5877-05 | RU 5877-05 S |
| 6 | RU 5871-06 | RU 5871-06 S | RU 5873-06 | RU 5873-06 S | RU 5875-06 | RU 5875-06 S | RU 5877-06 | RU 5877-06 S |
| 7 | RU 5871-07 | RU 5871-07 S | RU 5873-07 | RU 5873-07 S | RU 5875-07 | RU 5875-07 S | RU 5877-07 | RU 5877-07 S |
| 8 | RU 5871-08 | RU 5871-08 S | RU 5873-08 | RU 5873-08 S | RU 5875-08 | RU 5875-08 S | RU 5877-08 | RU 5877-08 S |
| 9 | RU 5871-09 | RU 5871-09 S | RU 5873-09 | RU 5873-09 S | RU 5875-09 | RU 5875-09 S | RU 5877-09 | RU 5877-09 S |
| 10 | RU 5871-10 | RU 5871-10 S | RU 5873-10 | RU 5873-10 S | RU 5875-10 | RU 5875-10 S | RU 5877-10 | RU 5877-10 S |
| 11 | RU 5871-11 | RU 5871-11 S | RU 5873-11 | RU 5873-11 S | RU 5875-11 | RU 5875-11 S | RU 5877-11 | RU 5877-11 S |
| 12 | RU 5871-12 | RU 5871-12 S | RU 5873-12 | RU 5873-12 S | RU 5875-12 | RU 5875-12 S | RU 5877-12 | RU 5877-12 S |
| 13 | RU 5871-13 | RU 5871-13 S | RU 5873-13 | RU 5873-13 S | RU 5875-13 | RU 5875-13 S | RU 5877-13 | RU 5877-13 S |
| 14 | RU 5871-14 | RU 5871-14 S | RU 5873-14 | RU 5873-14 S | RU 5875-14 | RU 5875-14 S | RU 5877-14 | RU 5877-14 S |
| 15 | RU 5871-15 | RU 5871-15 S | RU 5873-15 | RU 5873-15 S | RU 5875-15 | RU 5875-15 S | RU 5877-15 | RU 5877-15 S |
| 16 | RU 5871-16 | RU 5871-16 S | RU 5873-16 | RU 5873-16 S | RU 5875-16 | RU 5875-16 S | RU 5877-16 | RU 5877-16 S |

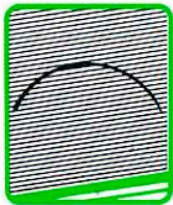

Chirurgische Nadeln
 Surgical Needles
 Suturas musculares y cutáneas
 Aiguilles chirurgicales
 Suture muscolari e cutanee

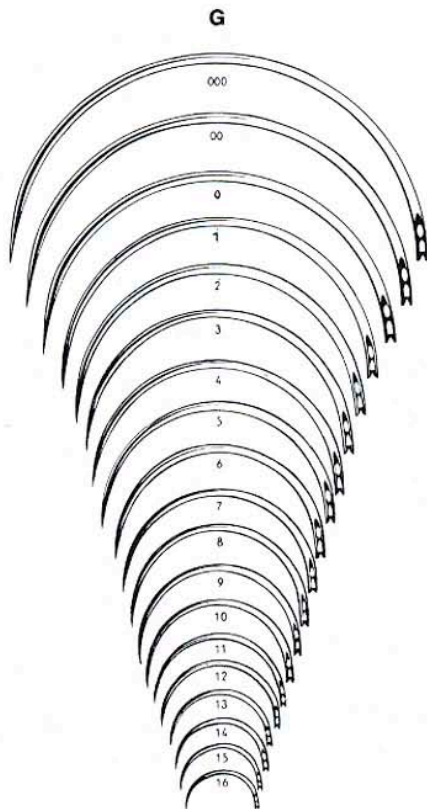

1/2 Kreis; 1/2 circle; 1/2 círculo; 1/2 cercle; 1/2 cerchio

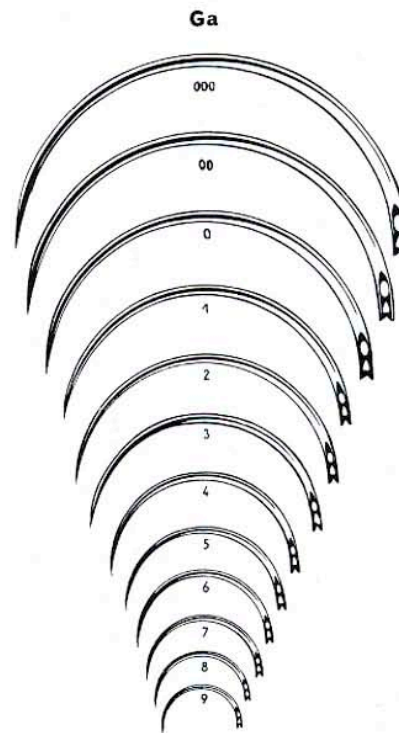

1/2 Kreis; 1/2 circle; 1/2 círculo; 1/2 cercle; 1/2 cerchio



| Fig. | RU 5878-30 | RU 5878-30 S | RU 5880-30 | RU 5880-30 S | RU 5882-30 | RU 5882-30 S | RU 5884-30 | RU 5884-30 S | RU 5886-30 | RU 5886-30-S | RU 5888-30 | RU 5888-30-S |
|------|------------|--------------|------------|--------------|------------|--------------|------------|--------------|------------|--------------|------------|--------------|
| 000 | RU 5878-20 | RU 5878-20 S | RU 5880-20 | RU 5880-20 S | RU 5882-20 | RU 5882-20 S | RU 5884-20 | RU 5884-20 S | RU 5886-20 | RU 5886-20 S | RU 5888-20 | RU 5888-20 S |
| 0 | RU 5878-10 | RU 5878-10 S | RU 5880-10 | RU 5880-10 S | RU 5882-10 | RU 5882-10 S | RU 5884-10 | RU 5884-10 S | RU 5886-10 | RU 5886-10 S | RU 5888-10 | RU 5888-10 S |
| 1 | RU 5879-01 | RU 5879-01 S | RU 5881-01 | RU 5881-01 S | RU 5883-01 | RU 5883-01 S | RU 5885-01 | RU 5885-01 S | RU 5887-01 | RU 5887-01 S | RU 5889-01 | RU 5889-01 S |
| 2 | RU 5879-02 | RU 5879-02 S | RU 5881-02 | RU 5881-02 S | RU 5883-02 | RU 5883-02 S | RU 5885-02 | RU 5885-02 S | RU 5887-02 | RU 5887-02 S | RU 5889-02 | RU 5889-02 S |
| 3 | RU 5879-03 | RU 5879-03 S | RU 5881-03 | RU 5881-03 S | RU 5883-03 | RU 5883-03 S | RU 5885-03 | RU 5885-03 S | RU 5887-03 | RU 5887-03 S | RU 5889-03 | RU 5889-03 S |
| 4 | RU 5879-04 | RU 5879-04 S | RU 5881-04 | RU 5881-04 S | RU 5883-04 | RU 5883-04 S | RU 5885-04 | RU 5885-04 S | RU 5887-04 | RU 5887-04 S | RU 5889-04 | RU 5889-04 S |
| 5 | RU 5879-05 | RU 5879-05 S | RU 5881-05 | RU 5881-05 S | RU 5883-05 | RU 5883-05 S | RU 5885-05 | RU 5885-05 S | RU 5887-05 | RU 5887-05 S | RU 5889-05 | RU 5889-05 S |
| 6 | RU 5879-06 | RU 5879-06 S | RU 5881-06 | RU 5881-06 S | RU 5883-06 | RU 5883-06 S | RU 5885-06 | RU 5885-06 S | RU 5887-06 | RU 5887-06 S | RU 5889-06 | RU 5889-06 S |
| 7 | RU 5879-07 | RU 5879-07 S | RU 5881-07 | RU 5881-07 S | RU 5883-07 | RU 5883-07 S | RU 5885-07 | RU 5885-07 S | RU 5887-07 | RU 5887-07 S | RU 5889-07 | RU 5889-07 S |
| 8 | RU 5879-08 | RU 5879-08 S | RU 5881-08 | RU 5881-08 S | RU 5883-08 | RU 5883-08 S | RU 5885-08 | RU 5885-08 S | RU 5887-08 | RU 5887-08 S | RU 5889-08 | RU 5889-08 S |
| 9 | RU 5879-09 | RU 5879-09 S | RU 5881-09 | RU 5881-09 S | RU 5883-09 | RU 5883-09 S | RU 5885-09 | RU 5885-09 S | RU 5887-09 | RU 5887-09 S | RU 5889-09 | RU 5889-09 S |
| 10 | RU 5879-10 | RU 5879-10 S | RU 5881-10 | RU 5881-10 S | RU 5883-10 | RU 5883-10 S | | | | | | |
| 11 | RU 5879-11 | RU 5879-11 S | RU 5881-11 | RU 5881-11 S | RU 5883-11 | RU 5883-11 S | | | | | | |
| 12 | RU 5879-11 | RU 5879-12 S | RU 5881-12 | RU 5881-12 S | RU 5883-12 | RU 5883-12 S | | | | | | |
| 13 | RU 5879-13 | RU 5879-13 S | RU 5881-13 | RU 5881-13 S | RU 5883-13 | RU 5883-13 S | | | | | | |
| 14 | RU 5879-14 | RU 5879-14 S | RU 5881-14 | RU 5881-14 S | RU 5883-14 | RU 5883-14 S | | | | | | |
| 15 | RU 5879-15 | RU 5879-15 S | RU 5881-15 | RU 5881-15 S | RU 5883-15 | RU 5883-15 S | | | | | | |
| 16 | RU 5879-16 | RU 5879-16 S | RU 5881-16 | RU 5881-16 S | RU 5883-16 | RU 5883-16 S | | | | | | |



Chirurgische Nadeln
Surgical Needles
Suturas musculares y cutáneas
Aiguilles chirurgicales
Suture muscolari e cutanee

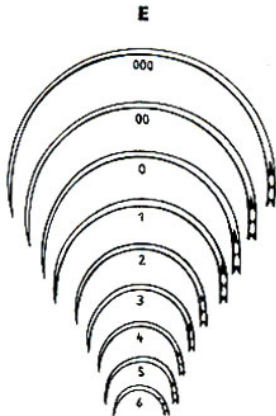
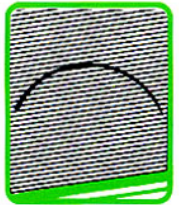

1/2 Kreis; 1/2 circle; 1/2 círculo; 1/2 cercle; 1/2 cerchio

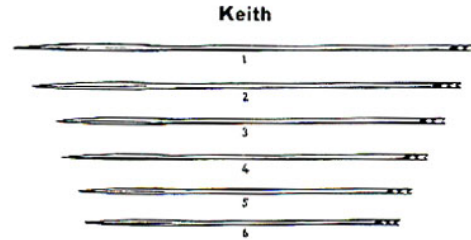

gerade; straight; rectas; droites; rette

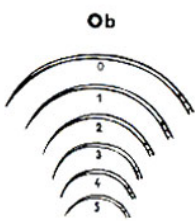

Fig.

| | | | | |
|-----|------------|--------------|------------|--------------|
| 000 | RU 5890-30 | RU 5890-30 S | RU 5892-30 | RU 5892-30 S |
| 00 | RU 5890-20 | RU 5890-20 S | RU 5892-20 | RU 5892-20 S |
| 0 | RU 5890-10 | RU 5890-10 S | RU 5892-10 | RU 5892-10 S |
| 1 | RU 5891-01 | RU 5891-01 S | RU 5893-01 | RU 5893-01 S |
| 2 | RU 5891-02 | RU 5891-02 S | RU 5893-02 | RU 5893-02 S |
| 3 | RU 5891-03 | RU 5891-03 S | | |
| 4 | RU 5891-04 | RU 5891-04 S | | |
| 5 | RU 5891-05 | RU 5891-05 S | | |
| 6 | RU 5891-06 | RU 5891-06 S | | |

| | | | |
|------------|--------------|------------|--------------|
| RU 5895-01 | RU 5895-01 S | RU 5897-01 | RU 5897-01 S |
| RU 5895-02 | RU 5895-02 S | RU 5897-02 | RU 5897-02 S |
| RU 5895-03 | RU 5895-03 S | RU 5897-03 | RU 5897-03 S |
| RU 5895-04 | RU 5895-04 S | RU 5897-04 | RU 5897-04 S |
| RU 5895-05 | RU 5895-05 S | RU 5897-05 | RU 5897-05 S |
| RU 5895-06 | RU 5895-06 S | RU 5897-06 | RU 5897-06 S |

Gefäß- und Augennadeln
Vein and eye needles
Agujas oftalmológicas y para venas
Aiguilles intraveineuses et ophtalmologiques
Aghi per vasi sanguinei e occhi



3/8 Kreis
 3/8 circle
 3/8 círculo
 3/8 cercle
 3/8 cerchio

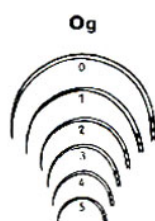

1/2 Kreis
 1/2 circle
 1/2 círculo
 1/2 cercle
 1/2 cerchio

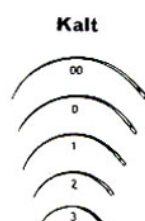

3/8 Kreis
 3/8 circle
 3/8 círculo
 3/8 cercle
 3/8 cerchio



1/2 Kreis
 1/2 circle
 1/2 círculo
 1/2 cercle
 1/2 cerchio



gerade
 straight
 rectas
 droites
 rette

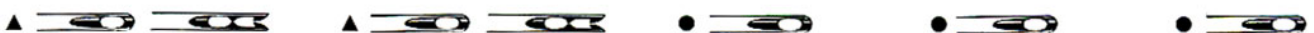
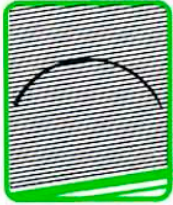

Fig.

| | | | | | | | | | |
|----|------------|--------------|------------|--------------|------------|------------|------------|------------|------------|
| 00 | RU 5898-10 | RU 5898-10 S | RU 5900-10 | RU 5900-10 S | RU 5902-20 | RU 5902-10 | RU 5904-20 | RU 5904-10 | |
| 0 | RU 5899-01 | RU 5899-01 S | RU 5901-01 | RU 5901-01 S | RU 5903-01 | RU 5903-01 | RU 5905-01 | RU 5905-01 | RU 5907-01 |
| 1 | RU 5899-02 | RU 5899-02 S | RU 5901-02 | RU 5901-02 S | RU 5903-02 | RU 5903-02 | RU 5905-02 | RU 5905-02 | RU 5907-02 |
| 2 | RU 5899-03 | RU 5899-03 S | | | | | | | |
| 3 | RU 5899-04 | RU 5899-04 S | | | | | | | |
| 4 | RU 5899-05 | RU 5899-05 S | | | | | | | |
| 5 | | | | | | | | | |



Chirurgische Nadeln
Surgical Needles
Suturas musculares y cutáneas
Aiguille chirurgicales
Suture muscolari e cutanee



Darmnadeln
 Intestinal needles
 Aguja intestinal
 Aiguille intestinale
 Aghi intestinali

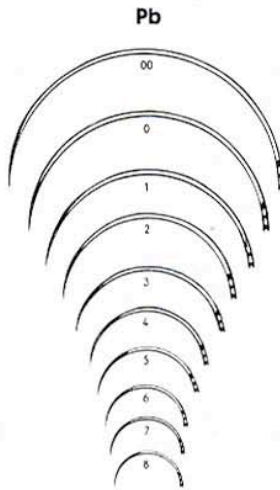

1/2 Kreis
 1/2 circle
 1/2 círculo
 1/2 cercle
 1/2 cerchio

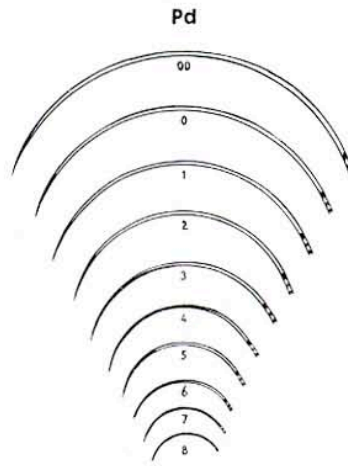

3/8 Kreis
 3/8 circle
 3/8 círculo
 3/8 cercle
 3/8 cerchio

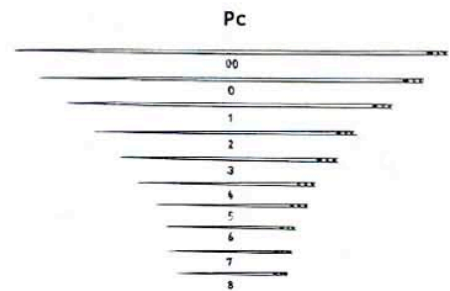

gerade
 straight
 rectas
 droites
 rette



Fig.

| | | |
|----|------------|--------------|
| 00 | RU 5908-20 | RU 5908-20 S |
| 0 | RU 5908-10 | RU 5908-10 S |
| 1 | RU 5909-01 | RU 5909-01 S |
| 2 | RU 5909-02 | RU 5909-02 S |
| 3 | RU 5909-03 | RU 5909-03 S |
| 4 | RU 5909-04 | RU 5909-04 S |
| 5 | RU 5909-05 | RU 5909-05 S |
| 6 | RU 5909-06 | RU 5909-06 S |
| 7 | RU 5909-07 | RU 5909-07 S |
| 8 | RU 5909-08 | RU 5909-08 S |

| | |
|------------|--------------|
| RU 5910-20 | RU 5910-20 S |
| RU 5910-10 | RU 5910-10 S |
| RU 5911-01 | RU 5911-01 S |
| RU 5911-02 | RU 5911-02 S |
| RU 5911-03 | RU 5911-03 S |
| RU 5911-04 | RU 5911-04 S |
| RU 5911-05 | RU 5911-05 S |
| RU 5911-06 | RU 5911-06 S |
| RU 5911-07 | RU 5911-07 S |
| RU 5911-08 | RU 5911-08 S |

| | |
|------------|--------------|
| RU 5912-20 | RU 5912-20 S |
| RU 5912-10 | RU 5912-10 S |
| RU 5913-01 | RU 5913-01 S |
| RU 5913-02 | RU 5913-02 S |
| RU 5913-03 | RU 5913-03 S |
| RU 5913-04 | RU 5913-04 S |
| RU 5913-05 | RU 5913-05 S |
| RU 5913-06 | RU 5913-06 S |
| RU 5913-07 | RU 5913-07 S |
| RU 5913-08 | RU 5913-08 S |



Mikro-Nadelhalter
Micro Needle Holders
Micro-Porta-agujas
Micro Porte-aiguilles
Micro-Portaghi

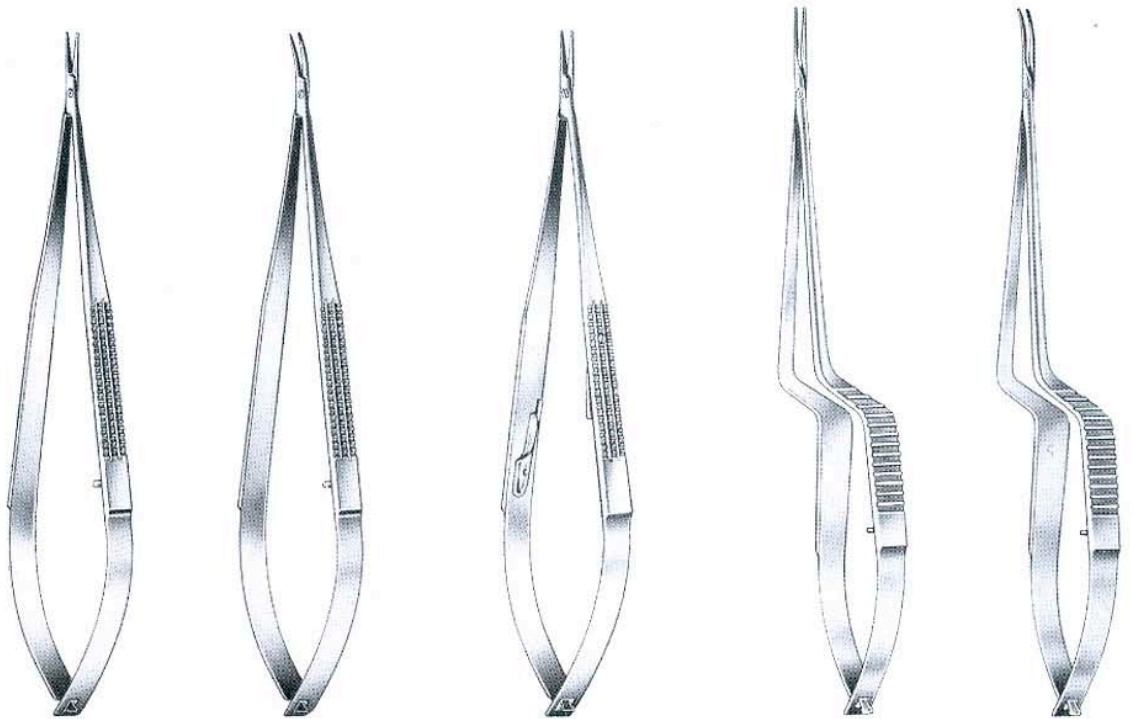
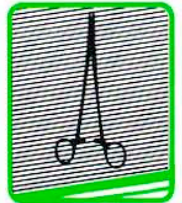

| | | | | | |
|---|-------------------|-------------------|-------------------|-------------------|-------------------|
| 15 cm/6" | RU 5850-15 | RU 5851-15 | | | |
| 18 cm/7" | RU 5850-18 | RU 5851-18 | RU 5852-18 | RU 5856-18 | RU 5857-18 |
| 22,5 cm/8 ³ / ₄ " | | | | RU 5856-23 | RU 5857-23 |



gerade
straight
rectas
droites
rette

mit Sperre
with ratchet
con cremallera
avec crémaillère
con cremagliera



gebogen
curved
curvas
courbes
curve

mit Sperre
with ratchet
con cremallera
avec crémaillère
con cremagliera



abgewinkelt
angled
acodadas hacia arriba
coudé vers le haut
angolari

mit Sperre
with ratchet
con cremallera
avec crémaillère
con cremagliera

| | | | | | | |
|---|-------------------|-------------------|-------------------|-------------------|-------------------|-------------------|
| 12 cm/4 ³ / ₄ " | RU 5860-12 | RU 5864-12 | RU 5861-12 | RU 5865-12 | RU 5863-12 | RU 5867-12 |
| 15 cm/6" | RU 5860-15 | RU 5864-15 | RU 5861-15 | RU 5865-15 | | |
| 18,5 cm/7 ¹ / ₄ " | RU 5860-18 | RU 5864-18 | RU 5861-18 | RU 5865-18 | | |
| 23 cm/9" | RU 5860-23 | | RU 5861-23 | | | |

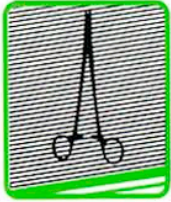

Nadelhalter
Needle Holders
Porta-agujas
Porte-aiguilles
Portaghi



RU 5918-13/1

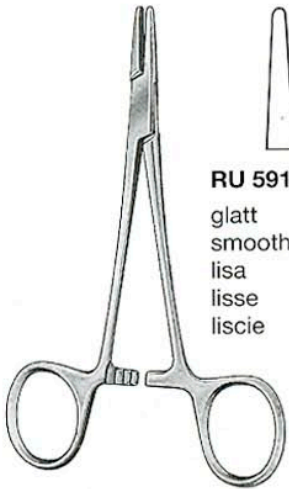

Halsey
13 cm/5"



RU 5918-13/2

glatt
smooth
lisa
lisse
liscie



Webster
13 cm/5"
RU 5920-13



glatt
smooth
lisa
lisse
liscie



Derf
12 cm/4³/₄"
RU 5922-12



Derf
12,5 cm/5"
RU 5924-12

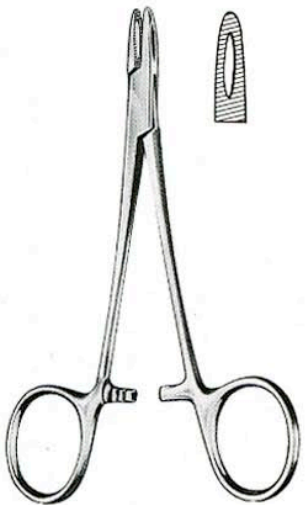

Collier
12,5 cm/5"
RU 5926-12



Hegar-Baumgartner
14 cm/5¹/₂"
RU 5927-14

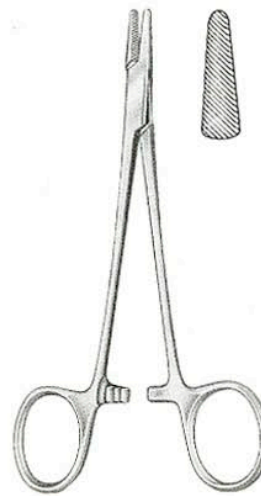

Brown
13 cm/5" RU 5928-13
18 cm/7" RU 5928-18



New Orleans
18 cm/7"
RU 5929-18





**Mikro-Nadelhalter
Micro Needle Holders
Micro-Porta-aguja
Micro Porte-aiguilles
Micro-Portaghi**

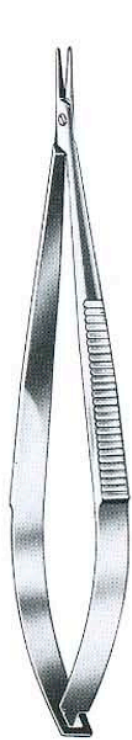

1 mm
gerade
straight
recta
droit
rette
RU 5950-14

Castroviejo
14 cm/5 1/2"

1 mm
gebogen
curved
curva
courbe
curve
RU 5951-14

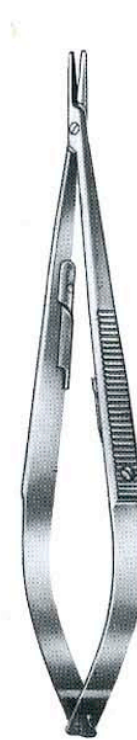

14 cm/5 1/2"
18 cm/7"

Castroviejo

1 mm
gerade
straight
rectas
droit
rette
RU 5952-14
RU 5952-18

1 mm
gebogen
curved
curvas
courbe
curve
RU 5953-14
RU 5953-18

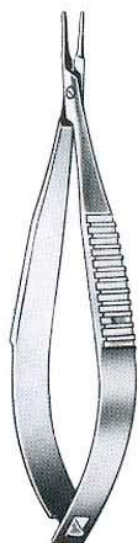

0,5 mm
gerade
straight
recta
droit
rette
RU 5956-09

Castroviejo
9 cm/3 1/2"

0,5 mm
gebogen
curved
curva
courbe
curve
RU 5957-09

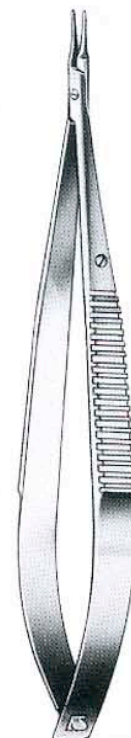

0,75 mm
gerade
straight
recta
droit
rette
RU 5956-14

Castroviejo
14 cm/5 1/2"

0,75 mm
gebogen
curved
curva
courbe
curve
RU 5957-14



Mikro-Nadelhalter
Micro Needle Holders
Micro-Porta-agujas
Micro Porte-aiguilles
Micro-Portaghi

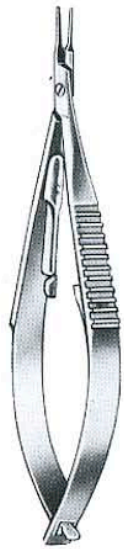

Castroviejo
9 cm/3 1/2"

0,5 mm
 gerade
 straight
 recta
 droit
 rette
RU 5958-09

0,5 mm
 gebogen
 curved
 curva
 courbe
 curve
RU 5959-09

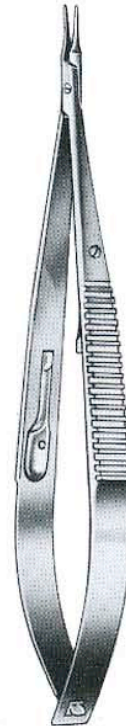

Castroviejo
14 cm/5 1/2"

0,75 mm
 gerade
 straight
 recta
 droit
 rette
RU 5958-14

0,75 mm
 gebogen
 curved
 curva
 courbe
 curve
RU 5959-14



Paton
11 cm/4 1/2"
RU 5960-11

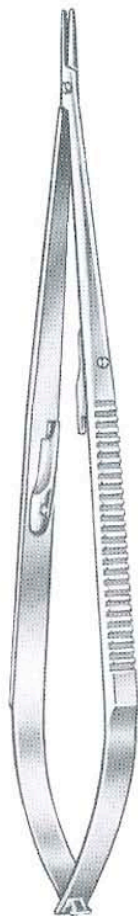

Jacobson

| cm | in | ohne Sperre without ratchet sin cremallera sans crémaillère senza cremagliera | mit Sperre with ratchet con cremallera avec crémaillère con cremagliera |
|----|-------|---|---|
| 18 | 7 | RU 5965-18 | RU 5966-18 |
| 21 | 8 1/4 | RU 5965-21 | RU 5966-21 |



Mikro-Nadelhalter
Micro Needle Holders
Micro-Porta-agujas
Micro Porte-aiguilles
Micro-Portaghi



Barraquer
 12 cm/4³/₄"
 RU 5971-12

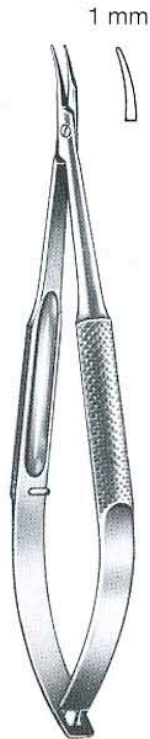

Barraquer
 14 cm/5¹/₂"
 RU 5971-14

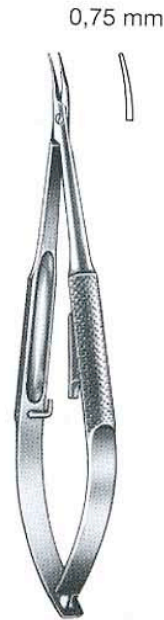

Barraquer
 12 cm/4³/₄"
 RU 5973-12

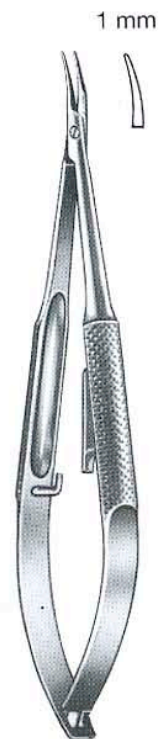

Barraquer
 14 cm/5¹/₂"
 RU 5973-14



Barraquer-Troutman
 10 cm/4"

0,5 mm



gerade
 straight
 recta
 droit
 rette

RU 5974-10

0,5 mm



gebogen
 curved
 curva
 courbe
 curve

RU 5975-10



Barraquer-Troutman
 10 cm/4"

0,5 mm



gerade
 straight
 recta
 droit
 rette

RU 5976-10

0,5 mm



gebogen
 curved
 curva
 courbe
 curve

RU 5977-10

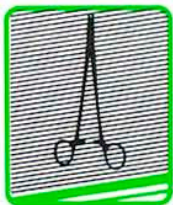

Mikro-Nadelhalter
Micro Needle Holders
Micro-Porta-agujas
Micro Porte-aiguilles
Micro-Portaghi

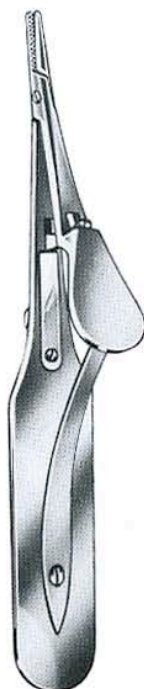

Arruga
 14 cm/5 1/2"



gerade
 straight
 recta
 droit
 rette
RU 5980-14



gebogen
 curved
 curva
 courbe
 curve
RU 5981-14



Stevens
 13 cm/5" **RU 5982-13**
 15 cm/6" **RU 5982-15**



Kalt
 14 cm/5 1/2"
RU 5986-14

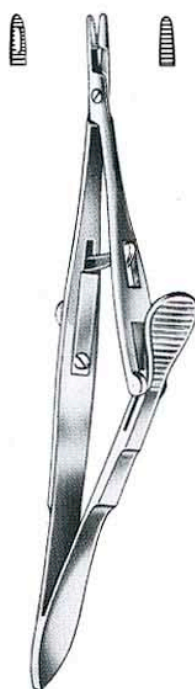

Castroviejo-Kalt
 13,5 cm/5 1/4"
RU 5987-14

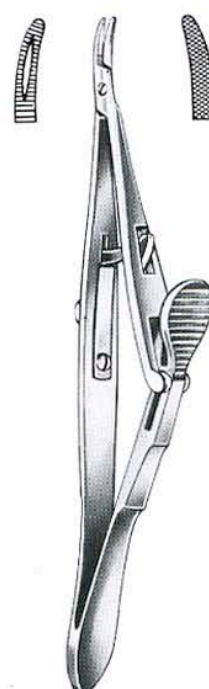

Kalt-Arruga
 14 cm/5 1/2"
RU 5988-14



Mikro-Nadelhalter
Micro Needle Holders
Micro-Porta-agujas
Micro Porte-aiguilles
Micro-Portaghi

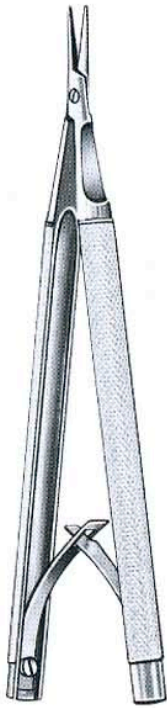
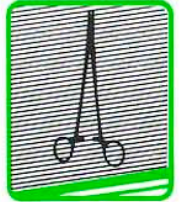

Castroviejo
12 cm/4³/₄"

gerade
straight
recta
droit
rette
RU 5990-12

gebogen
curved
curva
courbe
curve
RU 5991-12



Castroviejo
12 cm/4³/₄"

gerade
straight
recta
droit
rette
RU 5992-12

gebogen
curved
curva
courbe
curve
RU 5993-12



Castroviejo
13 cm/5"
RU 5989-13

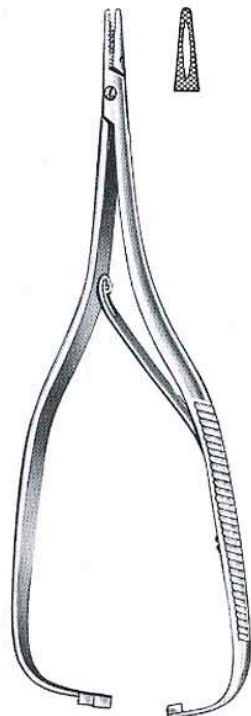

Boynton
12 cm/4³/₄"
RU 5994-12



Arruga
16 cm/6¹/₄"

gerade
straight
recta
droit
rette
RU 5996-16



gebogen
curved
curva
courbe
curve
RU 5997-16



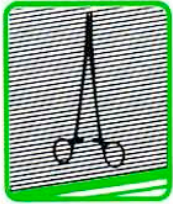

**Nadelhalter
Needle Holders
Porta-agujas
Porte-aiguilles
Portaghi**



Mayo-Hegar

14 cm/ 5 1/2"
16 cm/ 6 1/4"
18 cm/ 7"
20 cm/ 8"
24 cm/ 9 1/2"
26 cm/10 1/4"
30 cm/12"

**RU 6000-14
RU 6000-16
RU 6000-18
RU 6000-20
RU 6000-24
RU 6000-26
RU 6000-30**



RU 6001-16



Heaney

21 cm/8 1/4"
RU 6002-21

schlankes Modell
delicate pattern
modelo delegado
modèle fin
modello fine



Mayo-Hegar

16 cm/6 1/4" **RU 6003-16**
18 cm/7" **RU 6003-18**
20 cm/8" **RU 6003-20**

kräftiges Modell
heavy pattern
modelo robusto
modèle robuste
modello robusto

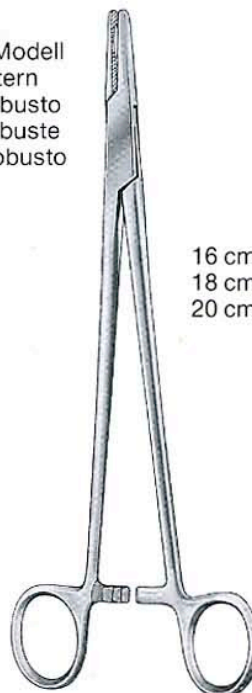

Hegar

16 cm/6 1/4"
18 cm/7"
20 cm/8"

**RU 6004-16
RU 6004-18
RU 6004-20**

RU 6004-20/01





Nadelhalter
Needle Holders
Porta-agujas
Porte-aiguilles
Portaghi

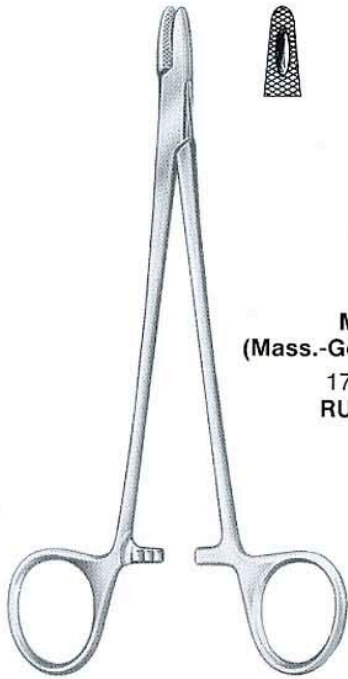
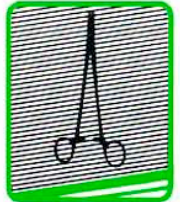

M. G. H.
(Mass.-General-Hospital)
17 cm/6³/₄"
RU 6005-17

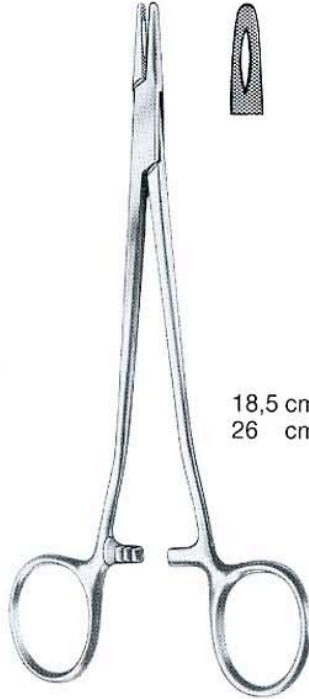

Sarot
18,5 cm/ 7¹/₄"
26 cm/10¹/₄"
RU 6006-18
RU 6006-26

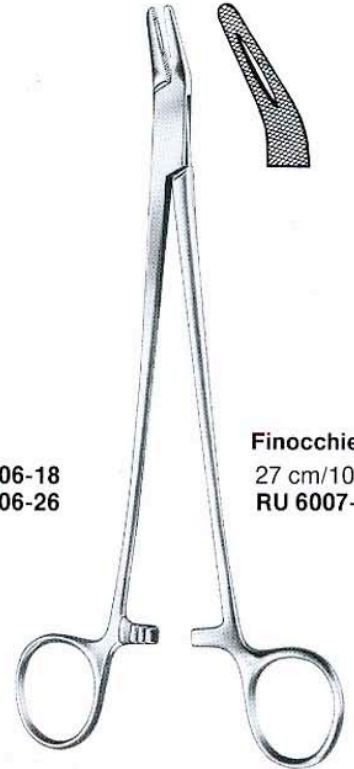

Finocchietto
27 cm/10¹/₂"
RU 6007-27



Masson
26,5 cm/10¹/₂"
RU 4850-64

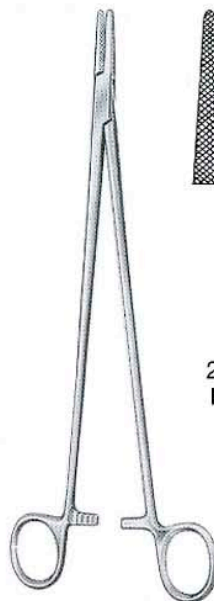

Jameson
23,5 cm/9¹/₄"
RU 6009-23

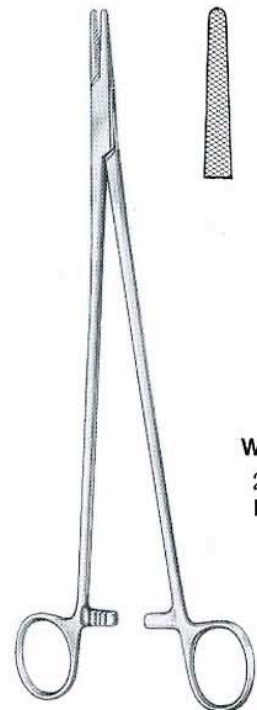

Wangensteen
27 cm/10¹/₂"
RU 6010-27



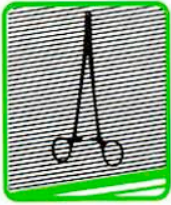

**Nadelhalter
Needle Holders
Porta-agujas
Porte-aiguilles
Portaghi**



Crile-Wood
15 cm/6"
RU 6012-15



Crile-Murray
15 cm/6"
RU 6014-15



Adson
18 cm/7"
RU 6016-18

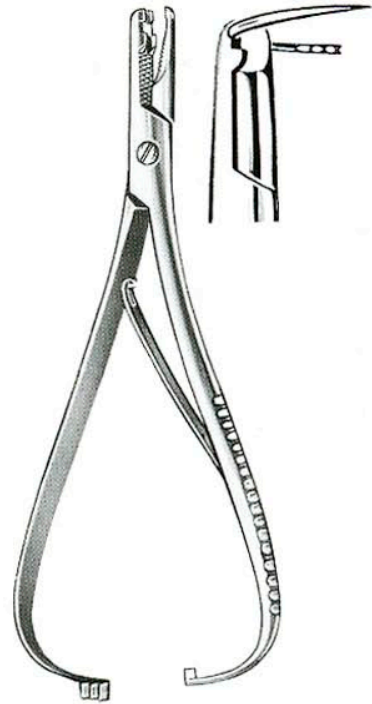

Ermold
17 cm/6³/₄" RU 6020-17
20 cm/8" RU 6020-20

Nadelhalter mit Schere
Needle holders with scissors
Porta-agujas con tijeras
Porte-aiguilles avec ciseaux
Portaghi con forbici



Baby-Olsen-Hegar
11 cm/4¹/₂"



RU 6029-11/1 RU 6029-11/2

glatt
smooth
lisa
lisse
liscie



Olsen-Hegar
14 cm/5¹/₂" RU 6030-14
18 cm/7" RU 6030-18



Olsen-Hegar
17 cm/6³/₄"
RU 6030-17





**Nadelhalter
Needle Holders
Porta-agujas
Porte-aiguilles
Portaghi**

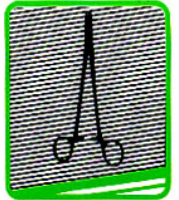

Nadelhalter mit Schere
Needle holders with scissors
Porta-agujas con tijeras
Porte-aiguilles avec ciseaux
Portaghi con forbici

L = Linkshänder
Left-handed
Para zurdos
Pour gaucher
Per mancini



Olsen-Hegar
14 cm/5½"
RU 6031-14

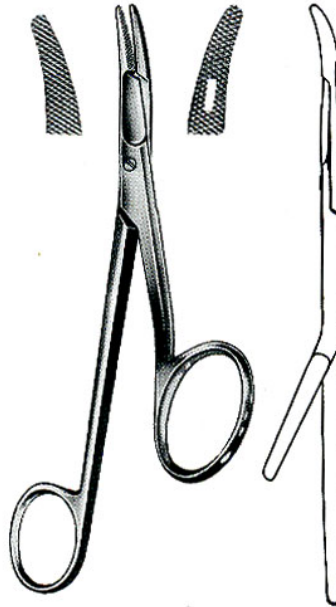

Gillies
16 cm/6¼"
RU 6032-16
RU 6032-16L



Gillies Slim
15 cm/6"
RU 6033-14
RU 6033-14L



Crile
15 cm/6"
RU 6036-15



Lichtenberg
20 cm/8"
RU 6038-20



Tönnis
18 cm/7"
RU 6039-18

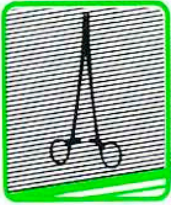

Nadelhalter
Needle Holders
Porta-agujas
Porte-aiguilles
Portaghi

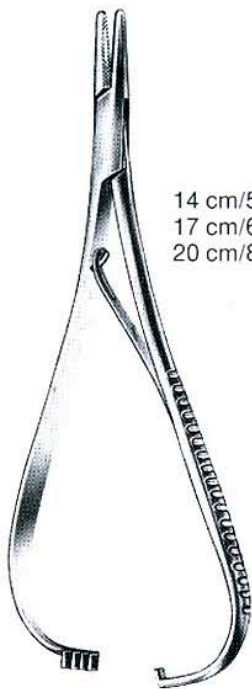

Mathieu

14 cm/5¹/₂"
17 cm/6³/₄"
20 cm/8"



RU 6040-14
RU 6040-17
RU 6040-20



RU 6042-14
RU 6042-17
RU 6042-20



Mathieu

14 cm/5¹/₂" RU 6043-14
17 cm/6³/₄" RU 6043-17
20 cm/8" RU 6043-20



Nadelhalter mit Hartmetalleinlagen
Needle Holders with Tungsten Carbide Inserts
Porta-agujas con placas de carburo tungsteno
Porte-aiguilles avec mors en carbure de tungstène
Portaghi con placche di carburo di tungsteno

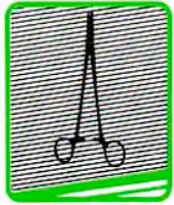

L = Linkshänder
 Left-handed
 Para zurdos
 Pour gaucher
 Per mancini

zwei Ringe abgewinkelt
 two rings angled
 dos anillos angulados
 deux anneaux coudés
 due anelli angolati

rudolftc



Par
 11,5 cm/4½" RU 6044-01/11
 13,5 cm/5½" RU 6044-01/13

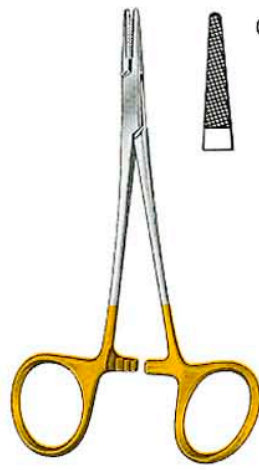

Neivert
 13 cm/5"
 RU 6044-13
 RU 6044-13L

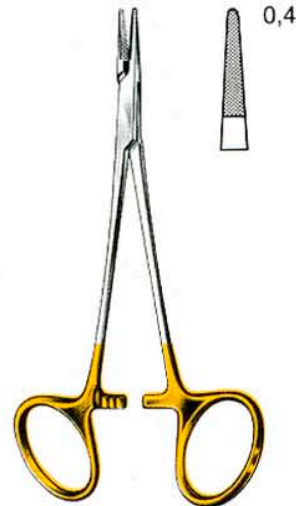

Neivert
 13 cm/5"
 RU 6045-13

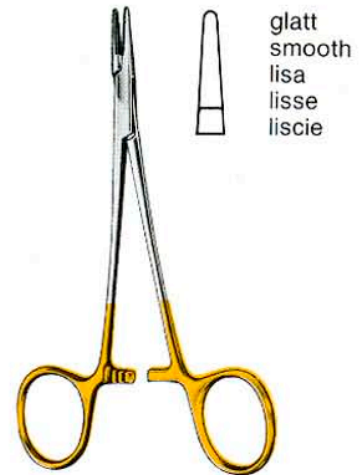

Webster
 13 cm/5"
 RU 6046-13
 RU 6046-13L

glatt
 smooth
 lisa
 lisse
 liscie



Derf
 12,5 cm/5"
 RU 6047-12



New Orleans
 18 cm/7"
 RU 6048-01/18

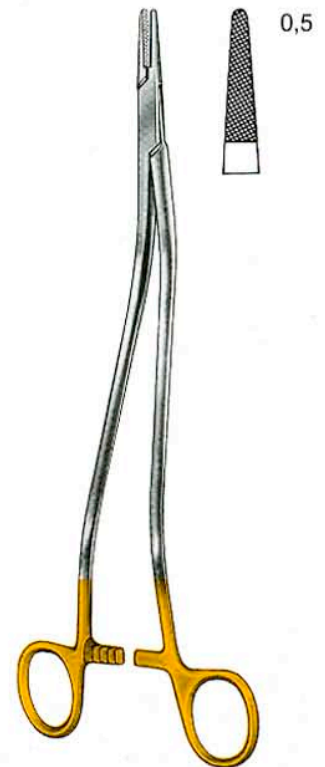

Bozemann
 20 cm/ 8" RU 6049-20
 24 cm/ 9½" RU 6049-24
 26 cm/10½" RU 6049-26

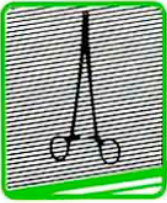

Nadelhalter mit Hartmetalleinlagen
Needle Holders with Tungsten Carbide Inserts
Porta-agujas con placas de carburo tungsteno
Porte-aiguilles avec mors en carbure de tungstène
Portaghi con placche di carburo di tungsteno



L = Linkshänder
 Left-handed
 Para zurdos
 Pour gaucher
 Per mancini

rudolftc



Mayo-Hegar

16 cm/6¼"
 16 cm/6¼"
 18 cm/7"
 18 cm/7"
 20 cm/8"
 24 cm/9½"
 26 cm/10½"
 30 cm/12"

RU 6050-16
 RU 6050-16L
 RU 6050-18
 RU 6050-18L
 RU 6050-20
 RU 6050-24
 RU 6050-26
 RU 6050-30

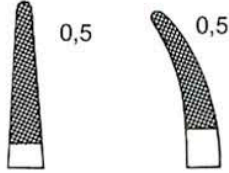

Hegar-Baumgartner

14 cm/5½"
 RU 6052-14
 RU 6052-14L

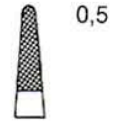

Mayo-Hegar

20 cm/8" RU 6053-20
 24 cm/9½" RU 6053-24

schweres Modell
 heavy pattern
 modelo robusto
 modèle robuste
 modello robusto



De Bakey

18 cm/7" RU 6054-18
 20 cm/8" RU 6054-20
 23 cm/9" RU 6054-23
 26 cm/10¼" RU 6054-26
 31 cm/12¼" RU 6054-31

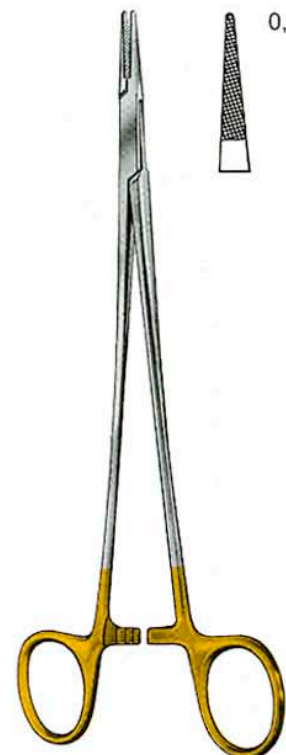

De Bakey-Fine

18 cm/7" RU 6054-68
 18 cm/7" RU 6054-68L
 20 cm/8" RU 6054-70
 23 cm/9" RU 6054-73
 26 cm/10¼" RU 6054-76
 31 cm/12¼" RU 6054-81





Nadelhalter mit Hartmetalleinlagen
Needle Holders with Tungsten Carbide Inserts
Porta-agujas con placas de carburo tungsteno
Porte-aiguilles avec mors en carbure de tungstène
Portaghi con placche di carburo di tungsteno

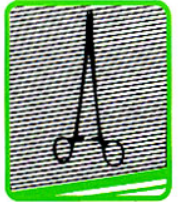

rudolf

L = Linkshänder
 Left-handed
 Para zurdos
 Pour gaucher
 Per mancini



Baby-Crile-Wood
 15 cm/6"
 RU 6055-01



RU 6055-15/1
 RU 6055-15/1L

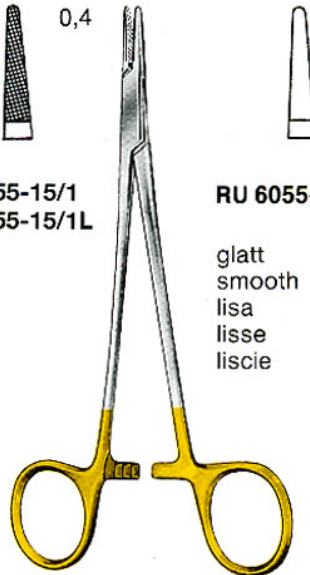

Crile-Wood
 15 cm/6"



RU 6055-15/2

glatt
 smooth
 lisa
 lisse
 liscie



Crile-Wood
 18 cm/7" RU 6055-18
 18 cm/7" RU 6055-18L
 20 cm/8" RU 6055-20
 23 cm/9" RU 6055-23
 26 cm/10¼" RU 6055-26
 31 cm/12¼" RU 6055-31



RU 6056-13/1
 RU 6056-13/1 TI

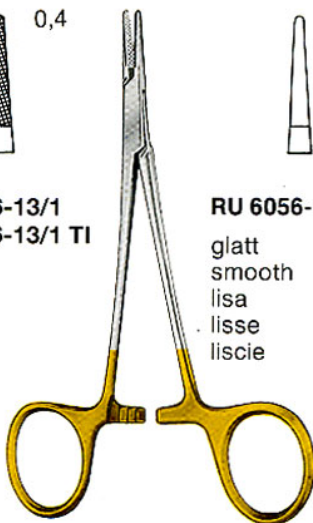

Halsey
 13 cm/5"



RU 6056-13/2

glatt
 smooth
 lisa
 lisse
 liscie



Converse
 12,5 cm/5"
 RU 6057-12

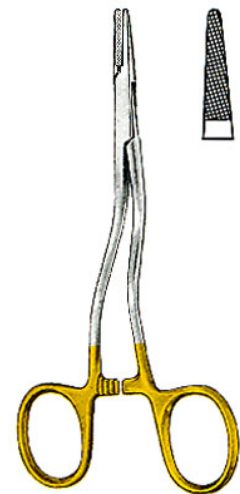
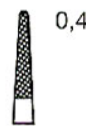

Kilner
 13,5 cm/5½"
 RU 6058-13



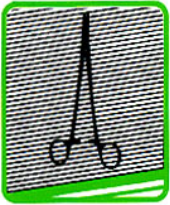

Nadelhalter mit Hartmetalleinlagen
Needle Holders with Tungsten Carbide Inserts
Porta-agujas con placas de carburo tungsteno
Porte-aiguilles avec mors en carbure de tungstène
Portaghi con placche di carburo di tungsteno



L = Linkshänder
 Left-handed
 Para zurdos
 Pour gaucher
 Per mancini

rudolf

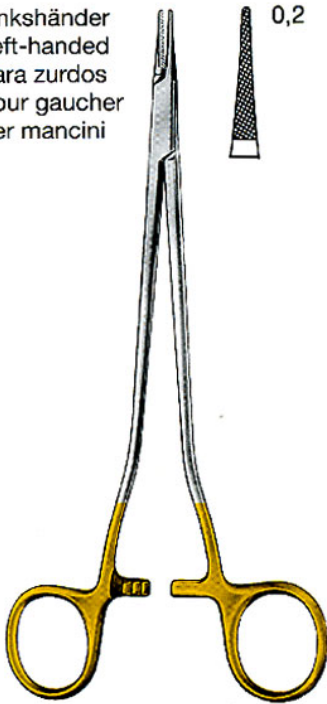

Hegar-Vascular

| | |
|-----------|----------------------|
| 14 cm/5½" | RU 6059-01/14 |
| 18 cm/7" | RU 6059-01/18 |
| 20 cm/8" | RU 6059-01/20 |
| 23 cm/9" | RU 6059-01/23 |



Ryder

| | |
|-----------|--------------------|
| 13 cm/5" | RU 6059-13 |
| 15 cm/6" | RU 6059-16 |
| 15 cm/6" | RU 6059-16L |
| 18 cm/7" | RU 6059-18 |
| 18 cm/7" | RU 6059-18L |
| 20 cm/8" | RU 6059-20 |
| 23 cm/9" | RU 6059-23 |
| 25 cm/10" | RU 6059-26 |

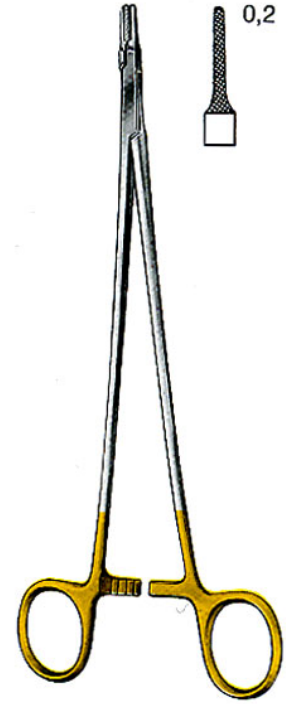

Micro-Ryder

| | |
|--------------|-------------------|
| 13 cm/5" | RU 6059-63 |
| 15 cm/6" | RU 6059-65 |
| 18 cm/7" | RU 6059-68 |
| 20 cm/8" | RU 6059-70 |
| 23 cm/9" | RU 6059-73 |
| 26,5 cm/10¼" | RU 6059-76 |



Rudolf
 (Swedish pattern)

| | |
|-----------|----------------------|
| 15 cm/6" | RU 6060-00/15 |
| 17 cm/6¾" | RU 6060-00/17 |
| 20 cm/8" | RU 6060-00/20 |

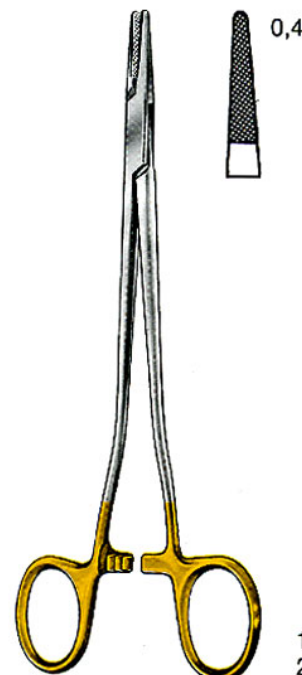

Sarot

| | |
|------------|-------------------|
| 18 cm/ 7" | RU 6060-18 |
| 26 cm/10¼" | RU 6060-26 |



Nadelhalter mit Hartmetalleinlagen
Needle Holders with Tungsten Carbide Inserts
Porta-agujas con placas de carburo tungsteno
Porte-aiguilles avec mors en carbure de tungstène
Portaghi con placche di carburo di tungsteno

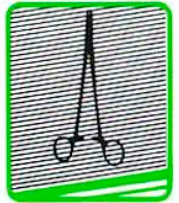

rudolfTC

Stratte
23 cm/9"
RU 6061-23

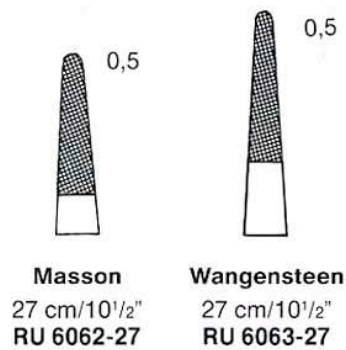
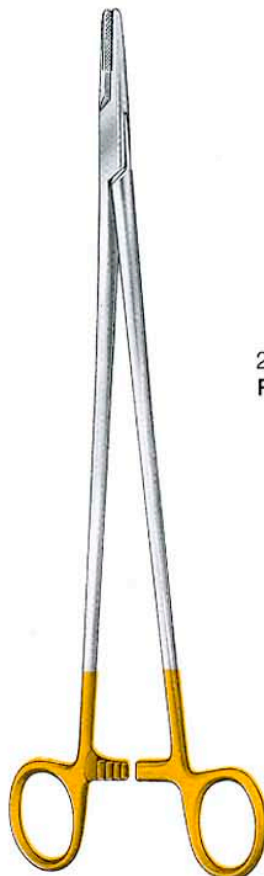

Masson
27 cm/10¹/₂"
RU 6062-27

Wangenstein
27 cm/10¹/₂"
RU 6063-27



Finocchietto
20 cm/ 8" RU 6064-20
27 cm/10¹/₂" RU 6064-27



Nadelhalter mit Hartmetalleinlagen
Needle Holders with Tungsten Carbide Inserts
Porta-agujas con placas de carburo tungsteno
Porte-aiguilles avec mors en carbure de tungstène
Portaghi con placche di carburo di tungsteno

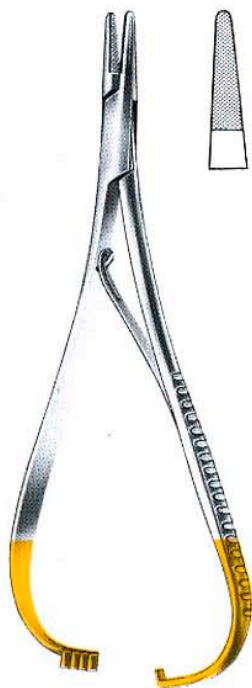

Mathieu

rudolftc



Mathieu

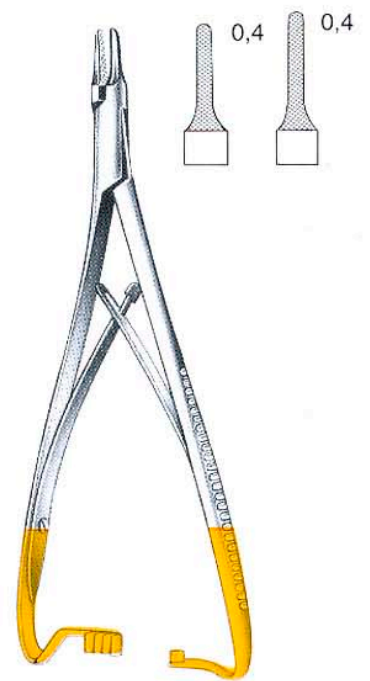

Mathieu-Ryder

| | | | |
|--------------|------------|------------|------------|
| 14 cm/5 1/2" | RU 6065-14 | | |
| 17 cm/6 3/4" | RU 6065-17 | RU 6066-17 | RU 6066-57 |
| 20 cm/8" | RU 6065-20 | RU 6066-20 | RU 6066-70 |
| 24 cm/9 1/2" | RU 6065-24 | RU 6066-24 | |

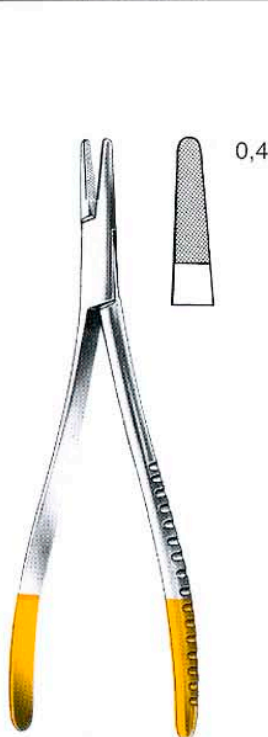

Langenbeck

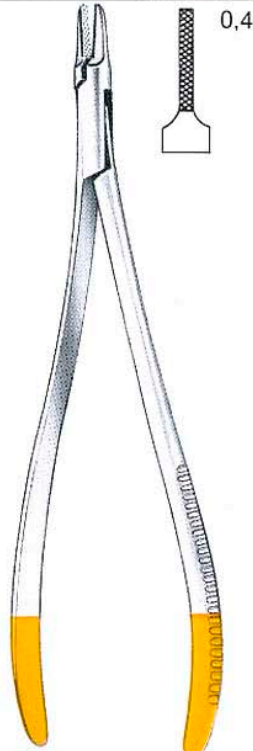

Langenbeck-Ryder

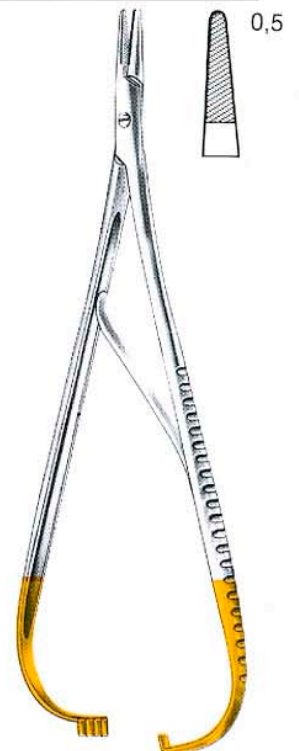

Lichtenberg

| | | | |
|--------------|------------|---------------|------------|
| 16 cm/6 1/4" | RU 6067-16 | | |
| 18 cm/7" | RU 6067-18 | | |
| 20 cm/8" | RU 6067-20 | RU 6067-18/00 | RU 6068-20 |



Nadelhalter mit Hartmetalleinlagen
Needle Holders with Tungsten Carbide Inserts
Porta-agujas con placas de carburo tungsteno
Porte-aiguilles avec mors en carbure de tungstène
Portaghi con placche di carburo di tungsteno



rudolfTC



Tönnis
18 cm/7"
RU 6069-18

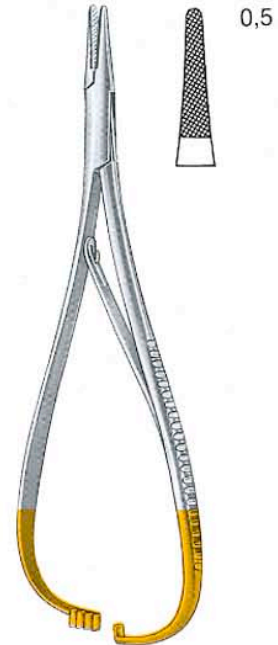

Mathieu-Kocher
14 cm/5¹/₂" RU 6070-14
17 cm/6³/₄" RU 6070-17
20 cm/8" RU 6070-20



Axhausen
18,5 cm/7¹/₄"
RU 6071-00/18

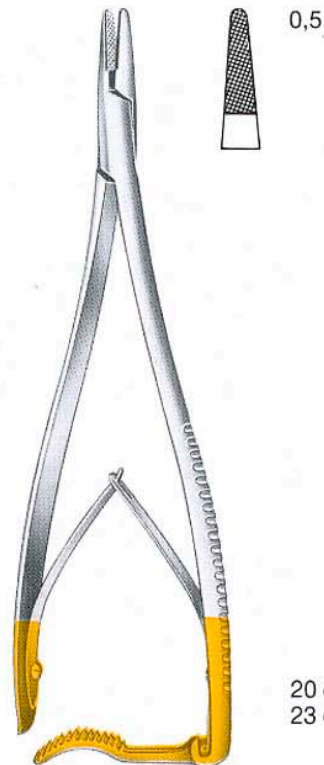

20 cm/8" RU 6071-02/20
23 cm/9" RU 6071-02/23

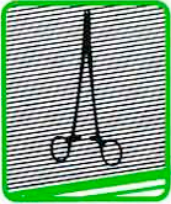

Nadelhalter mit Hartmetalleinlagen
Needle Holders with Tungsten Carbide Inserts
Porta-agujas con placas de carburo tungsteno
Porte-aiguilles avec mors en carbure de tungstène
Portaghi con placche di carburo di tungsteno



20 cm/ 8" **RU 6071-20**
 25 cm/10" **RU 6071-25**

rudolf TC

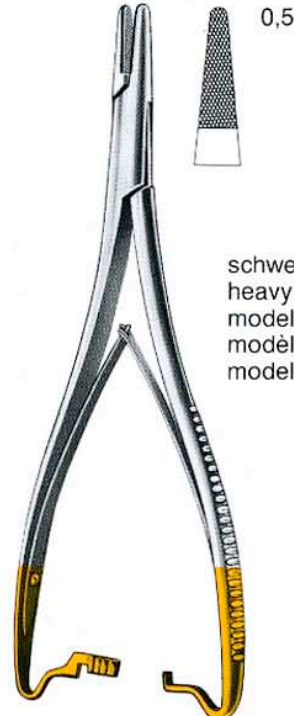

Mathieu
 20 cm/8" **RU 6072-20**
 24 cm/9 1/2" **RU 6072-24**

schweres Modell
 heavy pattern
 modelo robusto
 modèle robuste
 modello robusto



Metzenbaum
 17 cm/6 3/4" **RU 6073-17**
 20 cm/8" **RU 6073-20**



RU 6074-16 **RU 6075-16**

Arruga
 16 cm/6 1/4"



Boynton
 12 cm/4 3/4" **RU 6076-12**



Hösel
 20 cm/ 8" **RU 6077-20**
 25 cm/10" **RU 6077-25**



Nadelhalter mit Hartmetalleinlagen
Needle Holders with Tungsten Carbide Inserts
Porta-agujas con placas de carburo tungsteno
Porte-aiguilles avec mors en carbure de tungstène
Portaghi con placche di carburo di tungsteno

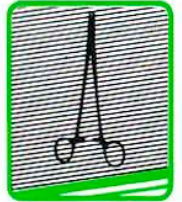

rudolfTC



Baby-Olsen-Hegar
11,5 cm/4½"
RU 6079-11



Olsen-Hegar
14 cm/5½"
RU 6080-14



Olsen-Hegar
17 cm/6¾"
RU 6080-17

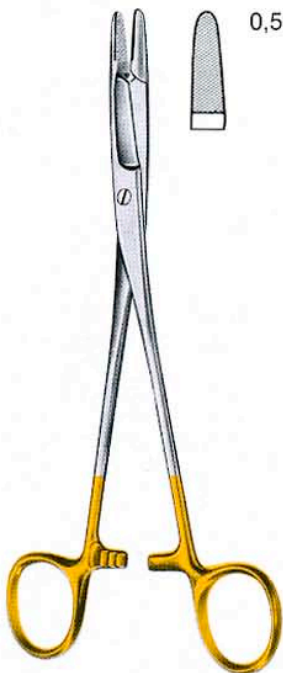

Olsen-Hegar
18 cm/7"
RU 6080-18



Gillies Slim
14,5 cm/5½"
RU 6081-14

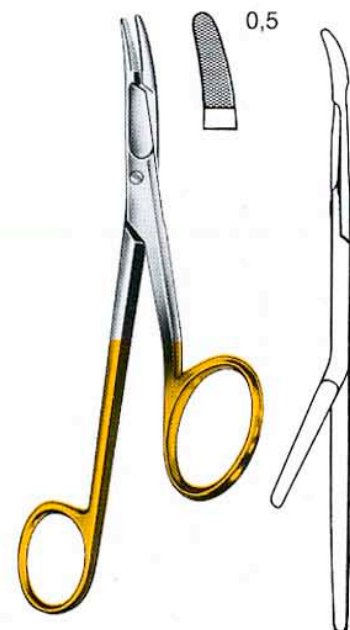

Gillies
16 cm/6¼"
RU 6081-16

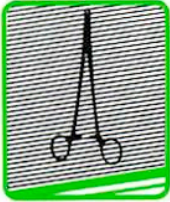

Nadelhalter mit Hartmetalleinlagen
Needle Holders with Tungsten Carbide Inserts
Porta-agujas con placas de carburo tungsteno
Porte-aiguilles avec mors en carbure de tungstène
Portaghi con placche di carburo di tungsteno



rudolfTC



Castroviejo

14 cm/5 1/2"
 18 cm/7"
 21 cm/8 1/4"



RU 6082-14/1
 RU 6082-18/1
 RU 6082-21/1

glatt
 smooth
 lisas
 lisses
 lisce



RU 6082-14/2
 RU 6082-18/2
 RU 6082-21/2

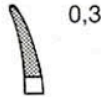

14 cm/5 1/2"
 18 cm/7"
 21 cm/8 1/4"

RU 6083-14/1
 RU 6083-18/1
 RU 6083-21/1



RU 6083-14/2
 RU 6083-18/2
 RU 6083-21/2

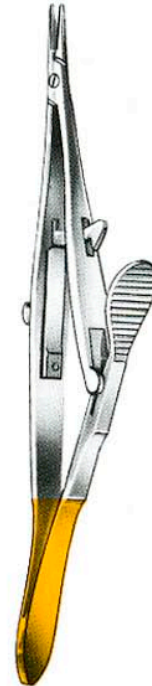

Kalt
 14 cm/5 1/2"



RU 6084-14/1



RU 6084-14/2

glatt
 smooth
 lisa
 lisse
 lisce



Barraquer
 14 cm/5 1/2"

RU 6085-14/01



RU 6085-14



RU 6085-14/03



RU 6085-14/02



ohne Sperre
 without ratchet
 sin cremallera
 sans crémaillère
 senza cremagliera

mit Sperre
 with ratchet
 con cremallera
 avec crémaillère
 con cremagliera



Castroviejo
 13 cm/5"

RU 6086-13

glatt
 smooth
 lisa
 lisse
 liscie

RU 6086-13/1

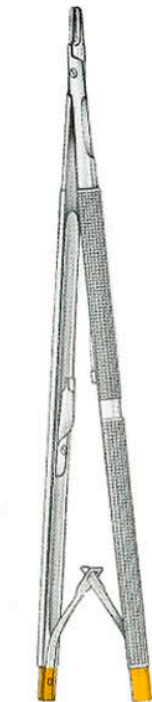
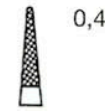

Hepp-Scheidel
 18 cm/7"

RU 6087-18/1

RU 6087-18/2

glatt
 smooth
 lisa
 lisse
 lisce





Nadelhalter mit Hartmetalleinlagen
Needle Holders with Tungsten Carbide Inserts
Porta-agujas con placas de carburo tungsteno
Porte-aiguilles avec mors en carbure de tungstène
Portaghi con placche di carburo di tungsteno

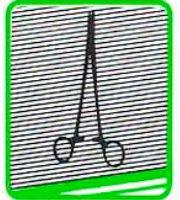

rudolf

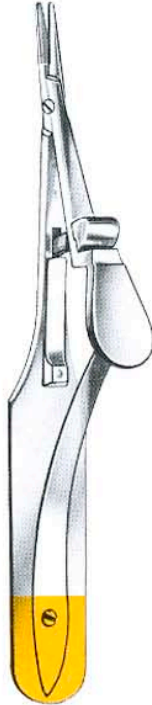

Arruga
14 cm/5 1/2"



RU 6088-14
gerade
straight
recta
droit
rette



RU 6089-14
gebogen
curved
curva
courbe
curve

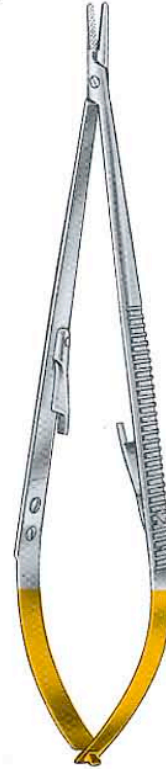

0,4

Jacobson

| | |
|--------------|-------------------|
| 18 cm/7" | RU 6090-18 |
| 20 cm/8" | RU 6090-20 |
| 23 cm/8 3/4" | RU 6090-23 |



Diethrich

0,3

| | |
|----------|---------|
| gerade | gebogen |
| straight | curved |
| rectas | curvas |
| droits | courbes |
| rette | curve |

| | | |
|--------------|-------------------|-------------------|
| 16 cm/6 1/4" | RU 6092-16 | RU 6093-16 |
| 18 cm/7" | RU 6092-18 | RU 6093-18 |
| 20 cm/8" | RU 6092-20 | RU 6093-20 |
| 23 cm/9" | RU 6092-23 | RU 6093-23 |
| 25 cm/10" | RU 6092-25 | RU 6093-25 |

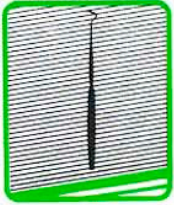

**Unterbindungsnadeln
Ligature Needles
Agujas para ligaduras
Aiguilles à ligatures
Aghi per legatura**



links
left
a la izquierda
à gauche
a sinistra



20 cm/8"



RU 6100-20



stumpf
blunt
romas
mousses
smussi



RU 6102-20



RU 6104-20



scharf
sharp
agudas
pointues
acuti



RU 6106-20

Deschamps-Standard

rechts
right
a la derecha
à droite
a destra



20 cm/8"

links
left
a la izquierda
à gauche
a sinistra



20 cm/8"



RU 6108-01



stumpf
blunt
romas
mousses
smussi



RU 6108-02



RU 6108-03



scharf
sharp
agudas
pointues
acuti



RU 6108-04

Deschamps

rechts
right
a la derecha
à droite
a destra



20 cm/8"



Unterbindungsnadeln
 Ligature Needles
 Aguja para ligaduras
 Aiguilles à ligatures
 Aghi per legatura

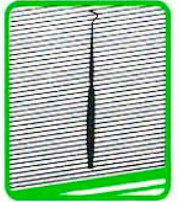

links
 left
 a la izquierda
 à gauche
 a sinistra

rechts
 right
 a la derecha
 à droite
 a destra

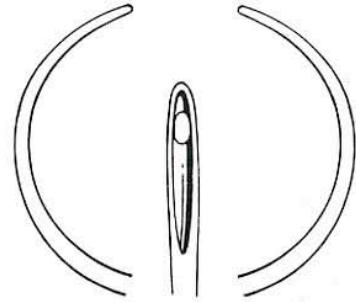

links
 left
 a la izquierda
 à gauche
 a sinistra

rechts
 right
 a la derecha
 à droite
 a destra



RU 6110-21

stumpf
 blunt
 romas
 mousses
 smussi

RU 6112-21

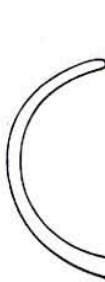

RU 6114-21

scharf
 sharp
 agudas
 pointues
 acuti

RU 6116-21



21 cm/8 1/4"

Deschamps



RU 6110-24



RU 6112-24

Deschamps

24 cm/9 1/2"

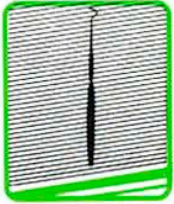

**Unterbindungsnadeln
Ligature Needles
Agujas para ligaduras
Aiguilles à ligatures
Aghi per legatura**



links
left
a la izquierda
à gauche
a sinistra

rechts
right
a la derecha
à droite
a destra

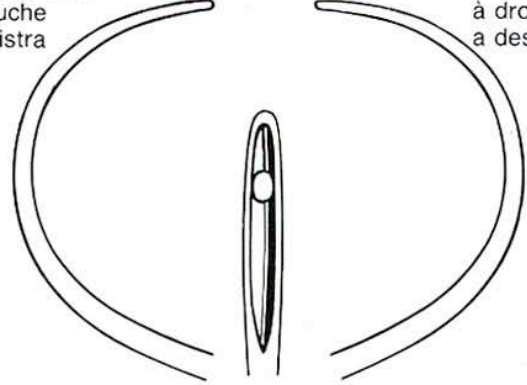

links
left
a la izquierda
à gauche
a sinistra

rechts
right
a la derecha
à droite
a destra

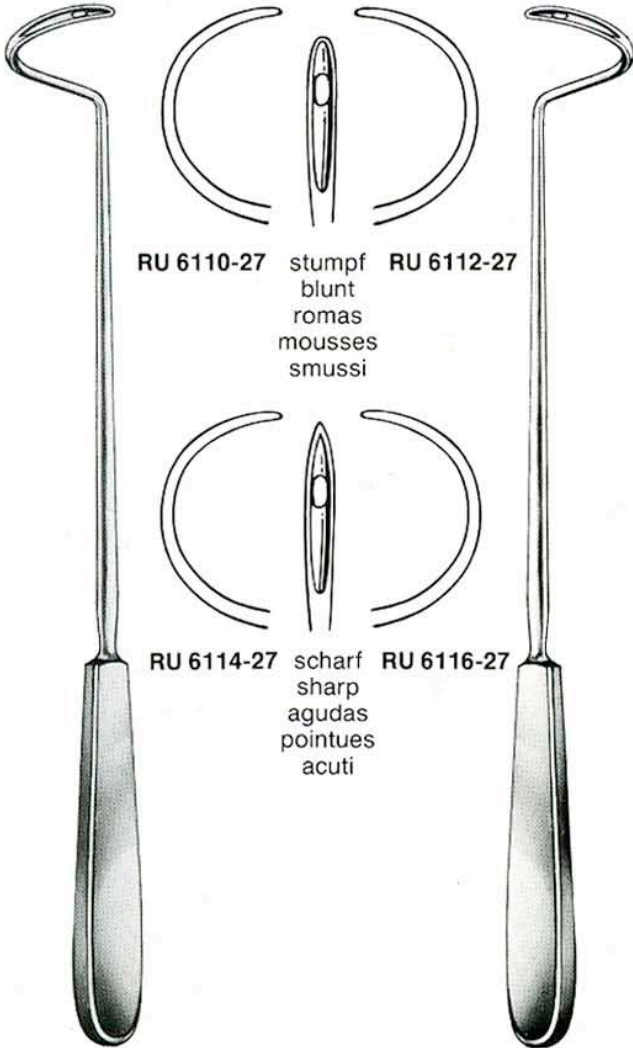

RU 6110-27 stumpf
blunt
romas
mousses
smussi

RU 6114-27 scharf
sharp
agudas
pointues
acuti

27 cm/10 1/2"

27 cm/10 1/2"

Deschamps

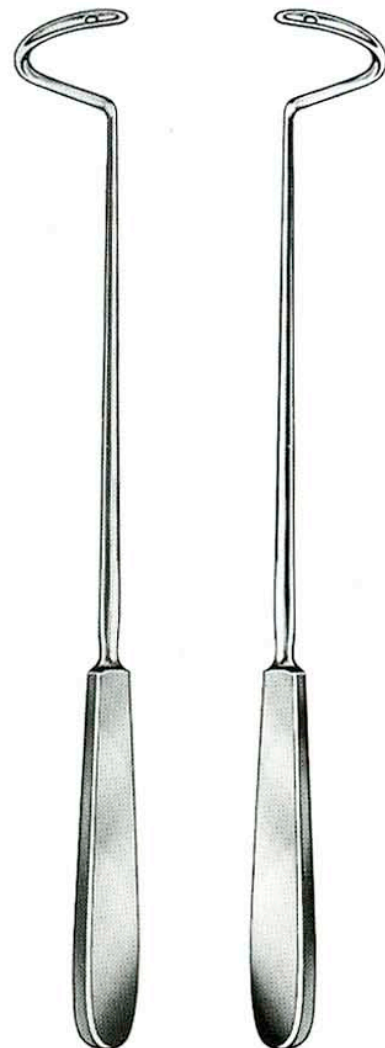

RU 6110-28 RU 6112-28

Deschamps
28 cm/11"



Unterbindungsnadeln
 Ligature Needles
 Aguja para ligaduras
 Aiguilles à ligatures
 Aghi per legatura

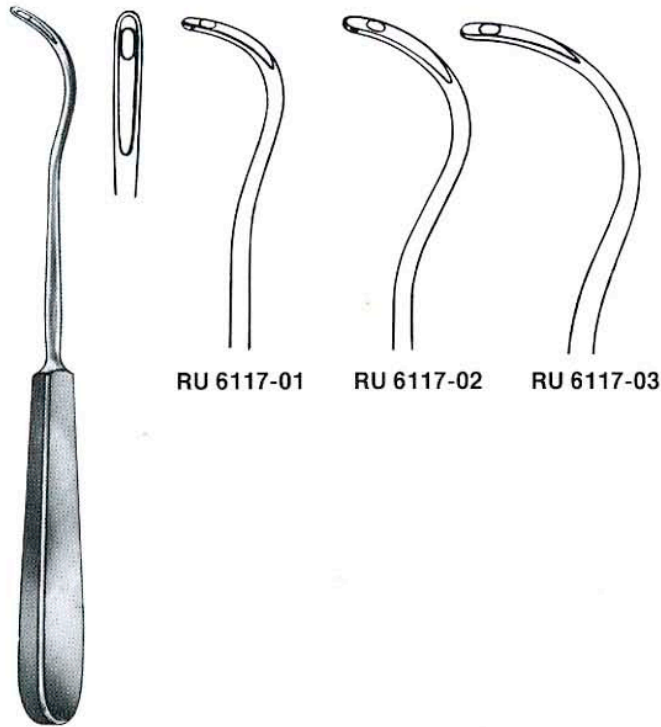
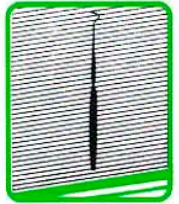

RU 6117-01

RU 6117-02

RU 6117-03

Kocher
19 cm/7 1/2"

links left
 a la izquierda
 à gauche
 a sinistra

rechts right
 a la derecha
 à droite
 a destra



Kronecker
13 cm/5"
RU 6118-15 RU 6119-15

links left
 a la izquierda
 à gauche
 a sinistra

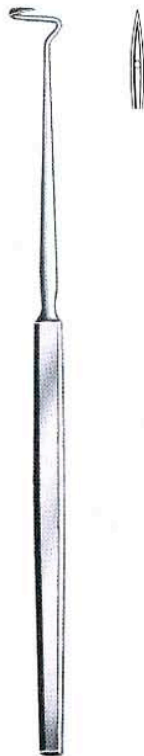

rechts right
 a la derecha
 à droite
 a destra



Dupuy-Weiss
22 cm/8 3/4"
RU 6120-01 RU 6120-02

links left
 a la izquierda
 à gauche
 a sinistra



rechts right
 a la derecha
 à droite
 a destra



Durham
21 cm/8 1/4"
RU 6120-21 RU 6120-22



Unterbindungsnadeln
Ligature Needles
Agujas para ligaduras
Aiguilles à ligatures
Aghi per legatura

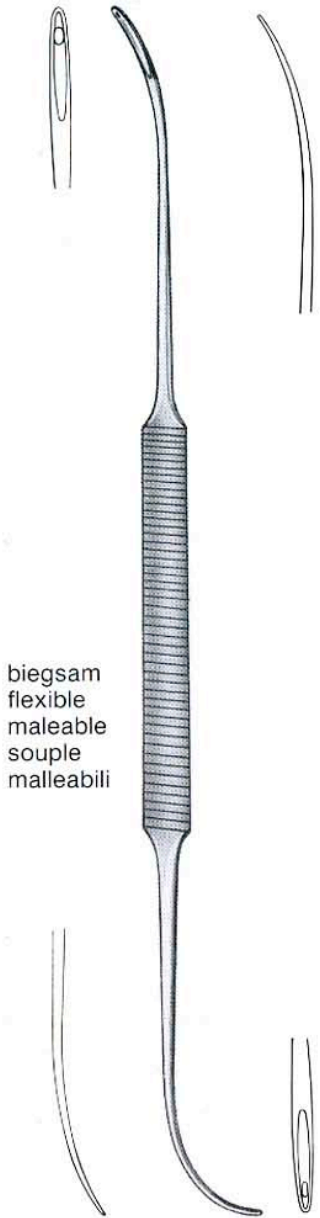

biegsam
flexible
maleable
souple
malleabili

Schmieden-Dick
32 cm/12 1/2"
RU 6121-01



Schmieden
21 cm/8 1/4"
RU 6121-21



biegsam
flexible
maleable
souple
malleabili

20 cm/8"
RU 6123-20



Cooper
19 cm/7 1/2"
RU 6124-19



Naht-Instrumente
Suture Instruments
Instrumental para sutura
Instruments à sutures
Strumenti per sutura

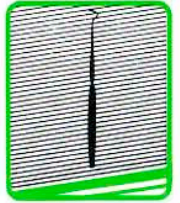

Reverdin
14 cm/5 1/2"



Fig. 1
RU 6126-01



Fig. 2
RU 6126-02



Fig. 3
RU 6126-03



Fig. 4
RU 6126-04



Naht-Instrumente
Suture Instruments
Instrumental para sutura
Instruments à sutures
Strumenti per sutura



Reverdin
19,5 cm/7³/₄"



Fig. 1
RU 6127-01



Fig. 2
RU 6127-02



Fig. 3
RU 6127-03



Fig. 4
RU 6127-04



Reverdin
22,5 cm/8³/₄"



Fig. 1
RU 6128-01



Fig. 2
RU 6128-02



Fig. 3
RU 6128-03



Fig. 4
RU 6128-04



Unterbindungsnadeln, Führungshohlsonden
Ligature Needles, Ligature Conductors
Agujas para ligaduras, Sondas conductoras
Aiguilles à ligatures, Sondes conductrices
Aghi per legatura, Sonde conduttrici

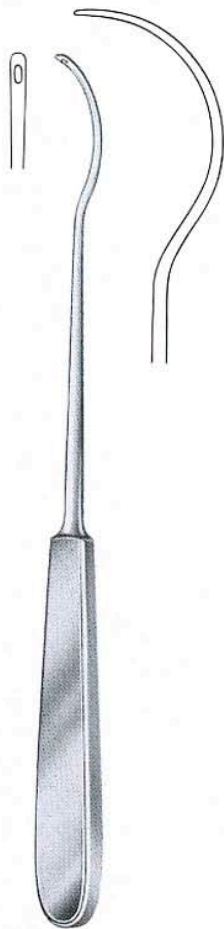

Brunner
25 cm/10"
RU 6129-25



Payr
22 cm/8³/₄"
RU 6130-22



Payr
22 cm/8³/₄"
RU 6131-22

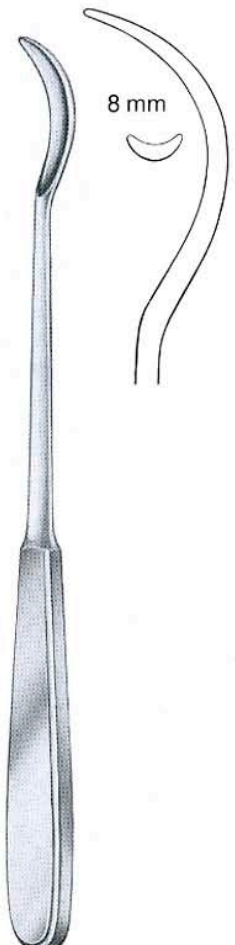

Brunner
24,5 cm/9³/₄"
RU 6131-51



Unterbindungsnadeln, Führungshohlsonden
Ligature Needles, Ligature Conductors
Agujas para ligaduras, Sondas conductoras
Aiguilles à ligatures, Sondes conductrices
Aghi per legatura, Sonde conduttrici



Brunner
30 cm/12"

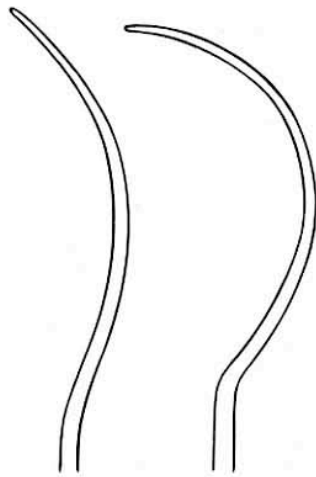

RU 6132-01 RU 6132-02



RU 6132-03

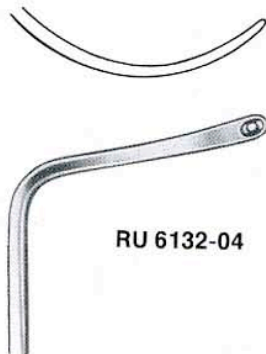

RU 6132-04



Brunner
30 cm/12"

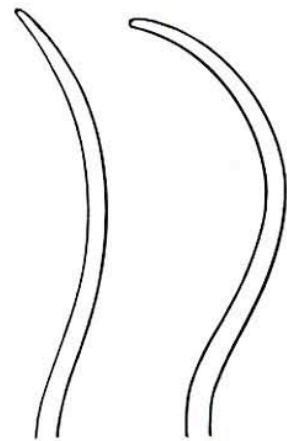

RU 6133-01 RU 6133-02

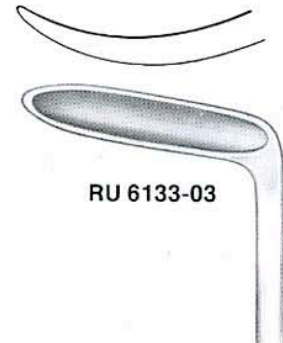

RU 6133-03

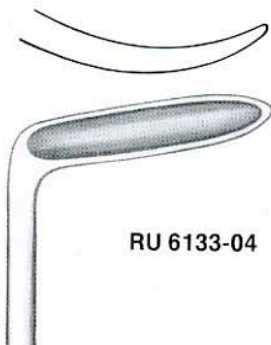

RU 6133-04



Führungshohlsonden
Ligature Conductors
Sondas conductoras
Sondes conductrices
Sonde conduttrici

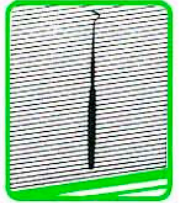

Kirschner
25,5 cm/10"
RU 6134-25



28 cm/11"
RU 6135-28



Brunner-Ferrozell
18 cm/ 7" RU 6136-18
27 cm/10 1/2" RU 6136-27



Schmieden-Payr
19 cm/7 1/2"
RU 6139-19



Schmieden
19 cm/7 1/2"
RU 6140-19





Führungshohlsonden, Fadenknoter, -fänger, -schlingendreher
Ligature Conductors, Knot Tiers, Ligature Catchers, Loop Twisters
Sondas conductoras, Porta ligaduras, Anudadores de hilos
Sondes conductrices, Instruments à noeuds, Porte-ligatures, Tords-fils
Sonde conduttrici, Strumenti per nodi, Portalegature, Torcifilo



König
19,5 cm/7³/₄"
RU 6141-19



König
19,5 cm/7³/₄"
RU 6142-19



König
20 cm/8"
RU 6143-20



Mod. Wien
23,5 cm/9¹/₄"
RU 6145-23



Bozemann
21 cm/8¹/₄"
RU 6146-21



23 cm/9"
RU 6147-23





Wundklammerzangen, Wundklammern
 Clip Applying Forceps, Wound Clips
 Pinzas para agrafes, Agrafes
 Pincas pour agrafes, Agrafes
 Pinze per graffe, Graffe

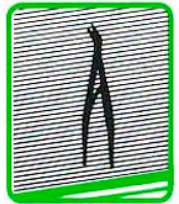

Michel
 12 cm/4³/₄"
 RU 6150-12

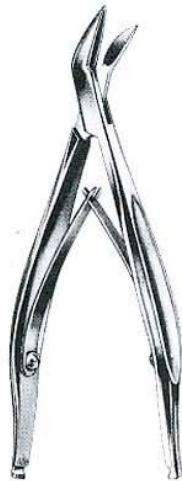

Michel modif.
 12,5 cm/5"
 RU 6151-12

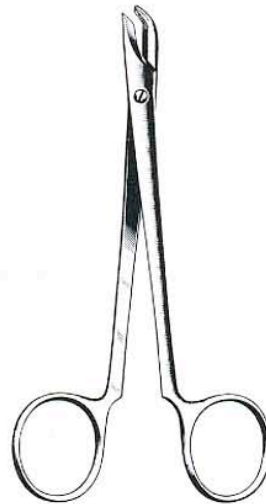

Collin
 13 cm/5"
 RU 6152-13

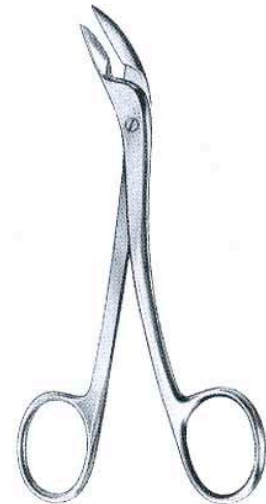

Richter-Heath
 14 cm/5¹/₂"
 RU 6153-14



Michel

Packungen à 1000 Stück
 packages of 1000 pieces
 paquetitos de 1000 piezas
 boîtes à 1000 pièces
 pacchetto di 1000 pezzi

| | |
|---------------|------------|
| 7,5 x 1,75 mm | RU 6155-01 |
| 11 x 2 mm | RU 6155-02 |
| 12 x 3 mm | RU 6155-03 |
| 14 x 3 mm | RU 6155-04 |
| 16 x 3 mm | RU 6155-05 |
| 18 x 3 mm | RU 6155-06 |
| 20 x 3 mm | RU 6155-07 |
| 22 x 3 mm | RU 6155-08 |

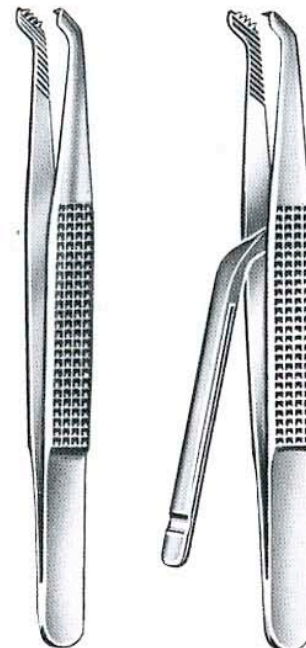

Child
 17 cm/6³/₄"
 RU 6158-01 RU 6158-02



Wundklammerpinzetten, Wundklammerbesteck
Clip Applying Forceps, Suture Set
Pinzas para agrafes, Estuches para suturas
Pinces pour agrafes, Boîte à suture
Pinze per graffe, Set per sutura



RU 6162-12

Michel
12 cm/4³/₄"



RU 6164-12



RU 6165-01

Wachenfeldt
12 cm/4³/₄"



RU 6165-12

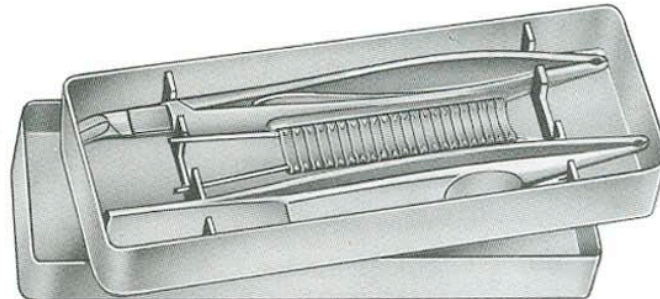

Michel
RU 6170-00



Wachenfeldt
12,5 cm/5"
RU 6166-12



Hegenbarth
12,5 cm/5"
RU 6168-12

Wundklammerbesteck, bestehend aus:

- 1 Wundklammerzange, Michel RU 6150-12
- 1 Wundrand-Faßpinzette Wachenfeldt mit Klammerhalter, RU 6165-01
- 50 Wundklammern Michel

Suture set, consisting of:

- 1 clip applying forceps Michel RU 6150-12
- 1 wound grasping forceps Wachenfeldt with clip holder RU 6165-01
- 50 wound clips Michel

Estuche de suturas compuesto de:

- 1 pinzas para agrafes Michel RU 6150-12
- 1 pinzas para unir bordes de herida Wachenfeldt con soporte-clip RU 6165-01
- 50 agrafes de Michel

Boîte à suture consistant en:

- 1 pince à agrafes Michel RU 6150-12
- 1 pince Wachenfeldt avec magasin porte-agrafes RU 6165-01
- 50 agrafes de Michel

Set per sutura composto da:

- 1 pinza per graffe Michel RU 6150-12
- 1 pinza per avvicinare i margini della ferita con porta-graffe di Wachenfeldt RU 6165-01
- 50 graffe Michel



Chirurgisches Taschenbesteck
Pocket Instrument Set
Estuche para pequeña cirugía
Trousse chirurgicale de poche
Astuccio tascabile

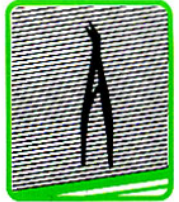

komplett in sterilisierbarer Roll-Tasche RU 6180-00/01 und Metalltui RU 8979-00

complete in boilable pocket RU 6180-00/01 and metal case RU 8979-00

completo en bolsa esterilizable RU 6180-00/01 y en estuche de metal RU 8979-00

complète en pochette stérilisable RU 6180-00/01 et boîte métallique RU 8979-00

completo in busta di tela sterilizabile RU 6180-00/01 e in scatola metallica RU 8979-00

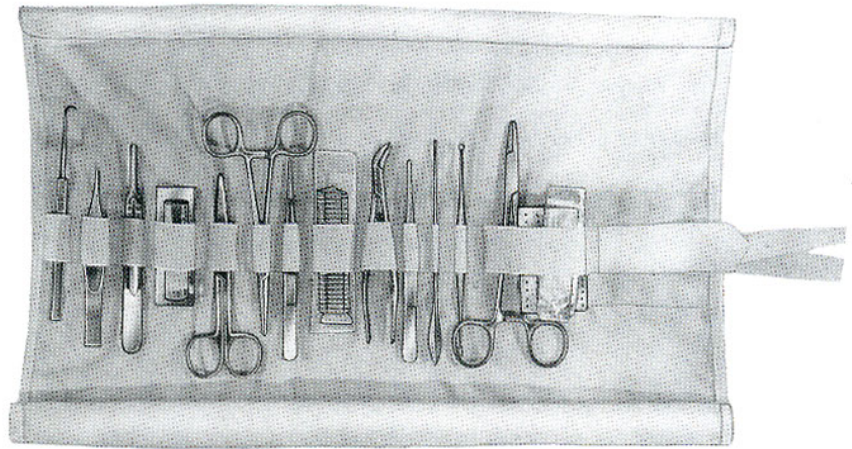

Inhalt

- RU 3074-14 1 Crile Arterienklemme, 14 cm, ger.
- RU 4469-14 1 scharfes Häkchen Bergmann
- RU 4850-04 1 Skalpellgriff, Nr. 4
- RU 4914-13 1 Myrtenblattsonde, 13 cm
- RU 5368-12 1 scharfer Doppellöffel
- RU 6000-16 1 Nadelhalter Mayo-Hegar, 16 cm
- RU 8910-50 1 Nadeldose gelocht, enthält 3 Nähnadeln
- RU 8910-75 1 Nadeldose gelocht, enthält 6 Skalpellklingen
- RU 1002-13 1 chirurgische Schere, ger. sp/st., 13 cm
- RU 4000-13 1 anatomische Pinzette, 13 cm
- RU 4100-13 1 chirurgische Pinzette, 13 cm
- RU 4320-11 1 Splitterpinzette Feilchenfeld, 11,5 cm
- RU 6151-12 1 Wundklammerzängchen Michel
- RU 6155-05 25 Wundklammern Michel, 16 x 3 mm
- RU 6185-00/50 1 Flacon Nähseide, steril in Alkohol
- RU 6180-00/01 1 Rolltasche allein, im Autoklav sterilisierbar

Contents

- RU 3074-14 1 Crile hemostatic forceps, 5 1/2", str.
- RU 4469-14 1 skin hook Bergmann
- RU 4850-04 1 detachable scalpel handle no. 4
- RU 4914-13 1 myrtle leaf probe, 5 1/8"
- RU 5368-12 1 sharp double curette
- RU 6000-16 1 needle holder Mayo-Hegar, 6 1/4"
- RU 8910-50 1 needle case, containing 3 suture needles
- RU 8910-75 1 needle case, containing 6 scalpel blades
- RU 1002-13 1 surgical scissors, str., sh/bl. 5 1/8"
- RU 4000-13 1 dissecting forceps, 5 1/8"
- RU 4100-13 1 tissue forceps, 5 1/8"
- RU 4320-11 1 Feilchenfeld splinter forceps, 4 1/2"
- RU 6151-12 1 Michel clip forceps
- RU 6155-05 25 Michel clips, 16 x 3 mm
- RU 6185-00/50 1 flacon of suture silk, sterile in alcohol
- RU 6180-00/01 sterilizable pocket only

Contenido

- RU 3074-14 1 pinza hemostática de Crile, 14 cm
- RU 4469-14 1 separador Bergmann
- RU 4850-04 1 mango de bisturios Núm. 4
- RU 4914-13 1 estilete abotonado, mirtiforme, 13 cm
- RU 5368-12 1 cucharilla doble cortante
- RU 6000-16 1 porta-aguja de Mayo-Hegar, 16 cm
- RU 8910-50 1 estuches para agujas, con 3 agujas
- RU 8910-75 1 estuches para agujas, con 6 hojas de bisturios
- RU 1002-13 1 tijeras, rectas, romas/agudas, 13 cm
- RU 4000-13 1 pinza de disección, 13 cm
- RU 4100-13 1 pinza de disección 13 cm, con dientes
- RU 4320-11 1 pinza para espinas de Feilchenfeld, 11,5 cm
- RU 6151-12 1 pinza para agrafes de Michel
- RU 6155-05 25 Michel agrafes
- RU 6185-00/50 1 frasco con seda esterilizada para sutura en alcohol
- RU 6180-00/01 bolsa esterilizable, suelta

Chirurgisches Taschenbesteck
Pocket Instrument Set
Estuche para pequeña cirugía
Trousse chirurgicale de poche
Astuccio tascabile
RU 6180-00

Contenu

- RU 3074-14 1 pince hémostatique de Crile, 14 cm
- RU 4469-14 1 crochet pointu Bergmann
- RU 4850-04 1 manche à bistouri, no. 4
- RU 4914-13 1 sonde à extrémité en feuille de myrte, 13 cm
- RU 5368-12 1 curette double, tranchante
- RU 6000-16 1 porte-aiguille de Mayo-Hegar, 16 cm
- RU 8910-50 1 boîte en métal perforée, inoxydable, contenant 3 aiguilles à sutures
- RU 8910-75 1 boîte métal perforée contenant 6 lames de bistouri
- RU 1002-13 1 ciseaux pointus, droits, 13 cm
- RU 4000-13 1 pince à disséquer, 13 cm
- RU 4100-13 1 pince à disséquer, 1 x 2 griffes, 13 cm
- RU 4320-11 1 pince à échardes de Feilchenfeld, 11,5 cm
- RU 6151-12 1 pince à agrafes de Michel
- RU 6155-05 25 agrafes de Michel, 16 x 3 mm
- RU 6185-00/50 1 flacon de soie à suturer, stérile en alcool
- RU 6180-00/01 pochette stérilisable seule

Contenuto

- RU 3074-14 1 pinza emostatica Crile, 14 cm
- RU 4469-14 1 gancio acuto, Bergmann
- RU 4850-04 1 bisturi a lame intercambiabili
- RU 4914-13 1 sonda mirtiforme, 13 cm
- RU 5368-12 1 curette doppio, acuto
- RU 6000-16 1 portaghi Mayo-Hegar, 16 cm
- RU 8910-50 1 astuccio per aghi, perforato, con 3 aghi
- RU 8910-75 1 astuccio per aghi, con 6 lame per bisturi
- RU 1002-13 1 forbice retta, 13 cm
- RU 4000-13 1 pinza anatomica, 13 cm
- RU 4100-13 1 pinza chirurgica, 13 cm
- RU 4320-11 1 pinza per scheggie Feilchenfeld, 11 cm
- RU 6151-12 1 pinza per graffe Michel
- RU 6155-05 25 graffe Michel, 16 x 3 mm
- RU 6185-00/50 1 flacone di seta per sutura sterile in alcool
- RU 6180-00/01 busta di tela sterilizabile, sola

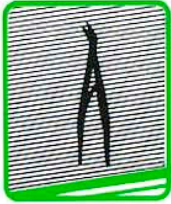

Venae Sectio Besteck
Venae Sectio Set
Estuche para Venotomía
Trousse de poche Venae Sectio
Astuccio tascabile per venotomia



komplett in sterilisierbarer Roll-Tasche RU 6185-00/01 und Metalltui RU 8979-00

complete in boilable pocket RU 6185-00/01 and metal case RU 8979-00

completo en bolsa esterilizable RU 6185-00/01 y en estuche de metal RU 8979-00

complète en pochette stérilisable RU 6185-00/01 et boîte métallique RU 8979-00

completo in busta di tela sterilizzabile RU 6185-00/01 e in scatola metallica RU 8979-00

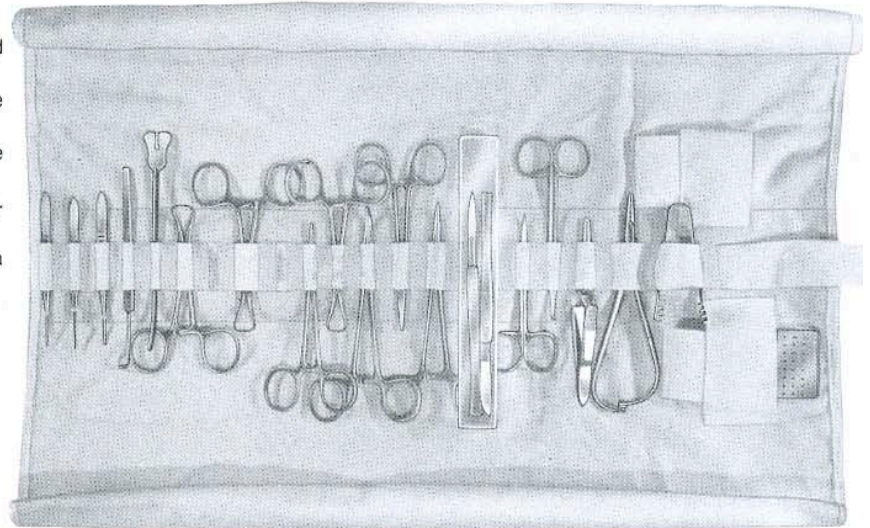

Inhalt

- RU 1631-10 1 Gefäßschere, geb. spitz, 10,5 cm
- RU 1705-11 1 Gefäßschere m. Knopf, ger.
- RU 4250-10 1 anatomische Pinzette, fein, 10,5 cm
- RU 4260-10 1 feine Pinzette, 1 x 2 Zähne, 10,5 cm
- RU 4642-07 1 Finsen Wundspreizer, feststellbar
- RU 4911-14 1 Doyen Hohlsonde, gebogen
- RU 6040-14 1 Mathieu Nadelhalter, schlank, 14 cm
- RU 6118-15 1 Unterbindungsnadel, feines kurzes Modell
- RU 6168-12 1 Hegenbarth Wundnahtpinzette
- RU 9974-11 1 Elschmig Faßpinzette, 1 x 2 Zähne, fein
- RU 3101-12 2 Arterienklemmen Mosquito, gebogen, 12,5 cm
- RU 3110-12 2 Arterienklemmen Mosquito, gerade, 1 x 2 Zähne
- RU 3600-09 3 Backhaus Tuckklemme, 9 cm
- RU 4865-01 1 Skalpell Bergmann
- RU 4865-02 1 Skalpell Bergmann
- RU 8910-50 1 Nadeldose gelocht
- RU 6185-00/01 Rolltasche allein, im Autoklav sterilisierbar

Contens

- RU 1631-10 1 vessel scissors, cvd. sharp, 4 1/8"
- RU 1705-11 1 vessel scissors, str., with ball point
- RU 4250-10 1 dressing forceps, fine, 4 1/8"
- RU 4260-10 1 fine forceps, 1 x 2 teeth, 4 1/8"
- RU 4642-07 1 Finsen retractor
- RU 4911-14 1 Doyen director, curved
- RU 6040-14 1 Mathieu needle holder, fine pattern, 5 1/2"
- RU 6118-15 1 ligature needle, fine short pattern
- RU 6168-12 1 Hegenbarth clip forceps
- RU 9974-11 1 Elschmig tissue forceps, 1 x 2 teeth, fine
- RU 3101-12 2 Halsted-Mosquito forceps, cvd., 5"
- RU 3110-12 2 idem str. 1 x 2 teeth, 5"
- RU 3600-09 3 Backhaus towel forceps, 3 1/2"
- RU 4865-01 1 scalpel Bergmann
- RU 4865-02 1 scalpel Bergmann
- RU 8910-50 1 needle container, perforated
- RU 6185-00/01 sterilisable pocket only

Contenido

- RU 1631-10 1 tijeras curvas agudas, 10,5 cm
- RU 1705-11 1 tijeras para arterias y vasos abotonadas
- RU 4250-10 1 pinza de disección, 10,5 cm
- RU 4260-10 1 idem. 1 x 2 dientes, 10,5 cm
- RU 4642-07 1 Finsen separador ajustable
- RU 4911-14 1 Doyen estilete, curvo
- RU 6040-14 1 Mathieu porta-agujas, 14 cm, fina
- RU 6118-15 1 aguja para ligaduras, fina
- RU 6168-12 1 pinza para suturas Hegenbarth
- RU 9974-11 1 pinza Elschmig 1 x 2 dientes
- RU 3101-12 2 Halstead-Mosquito pinzas hemostáticas, curvas
- RU 3110-12 2 idem, rectas, 1 x 2 dientes
- RU 3600-09 3 Backhaus pinzas para campos, 9 cm
- RU 4865-01 1 bisturios
- RU 4865-02 1 bisturios
- RU 8910-50 1 estuche para agujas
- RU 6185-00/01 bolsa esterilizable

Venae Sectio Besteck
Venae Sectio Set
Estuche para Venotomía
Trousse de poche Venae Sectio
Astuccio tascabile per venotomia
RU 6185-00

Contenu

- RU 1631-10 1 ciseaux vasculaires, courbes, pointus, 10,5 cm
- RU 1705-11 1 ciseaux vasculaires, droits, 1 lame boutonnée
- RU 4250-10 1 pince a disséquer, fine, 10,5 cm
- RU 4260-10 1 pince à griffes, 1 x 2 griffes, fine, 10,5 cm
- RU 4642-07 1 ecarteur de Finsen, avec verrou
- RU 4911-14 1 sonde cannelée de Doyen, courbe
- RU 6040-14 1 porte-aiguille de Mathieu, délicate, 14 cm
- RU 6118-15 1 aiguille à ligatures, modèle fin, court
- RU 6168-12 1 pince à sutures de Hegenbarth
- RU 9974-11 1 pince à griffes d'Elschnig, 10,5 cm
- RU 3101-12 2 pinces hémostatiques légères de Halstead, courbes sur le plat
- RU 3110-12 2 pinces hémostatiques légères de Halstead, droites, 1 x 2 griffes
- RU 3600-09 3 pinces à champs de Backhaus, 9 cm
- RU 4865-01 1 bistouri Bergmann
- RU 4865-02 1 bistouri Bergmann
- RU 8910-50 1 boîte perforée à aiguilles
- RU 6185-00/01 pochette stérilisable seule

Contenuto

- RU 1631-10 1 forbice curve, acuta/acuta, 10,5 cm
- RU 1705-11 1 forbice per vasi, bottonate, retta, 11,5 cm
- RU 4250-10 1 pinza per dissezione, 10 cm
- RU 4260-10 1 pinza fine a 1:2 denti, 10,5 cm
- RU 4642-07 1 divaricatore
- RU 4911-14 1 sonda scanalata Doyen, curva
- RU 6040-14 1 portaghi Mathieu, 14 cm, fina
- RU 6118-15 1 ago fino per legature
- RU 6168-12 1 pinza Hegenbarth per i margini della ferita
- RU 9974-11 1 pinza per afferrare tessuti, 1:2 denti, fine
- RU 3101-12 2 pinze emostatiche Mosquito, curve, 12,5 cm
- RU 3110-12 2 pinze emostatiche Mosquito, rette, 12,5 cm
- RU 3600-09 3 pinze fissateli Backhaus, 9 cm
- RU 4865-01 1 Bergmann bisturi
- RU 4865-02 1 Bergmann bisturi
- RU 8910-50 1 astuccio per aghi, perforato
- RU 6185-00/01 solo busta di tela sterilizzabile



Gipsmesser, Gipssägen, Gipsspreizer
Plaster Instruments
Instrumental para vendajes enyesados
Pinces et cisailles pour les plâtres
Strumenti per apparecchi gessati



Hopkins
20 cm/8"
RU 6210-20



Esmarch
18 cm/7"
RU 6212-18



Reiner
18,5 cm/7 1/4"
RU 6214-18

Gipssäge
Plaster saw
Sierra para yeso
Scie à plâtre
Sega per apparecchi gessati



Engel
RU 6225-14



Henning
28 cm/11"
RU 6230-28



Beeson
30 cm/12"
RU 6231-30

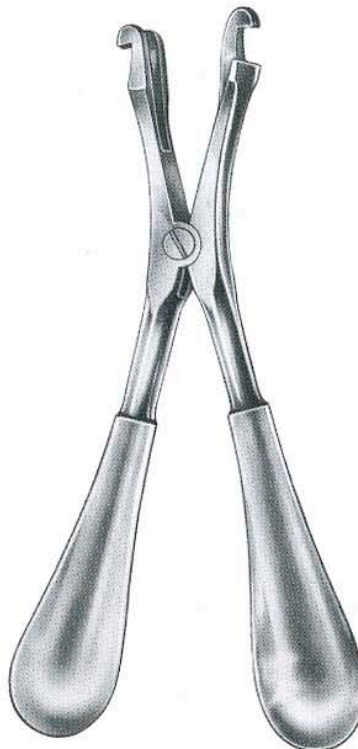

Haglund-Stille
28 cm/11"
RU 6232-28

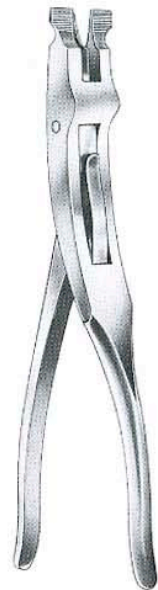

Mod. USA
23 cm/9"
RU 6234-23



Oscillierende Gipssäge
Oscillating Plaster Saw
Sierras electricas, para yesos, oscilantes
Scie oscillante à plâtre
Sega oscillante



RU 6220-20
Standard



RU 6220-22
ACCU

RU 6220-20 } inkl. Sägeblätter
 incl. saw blades
 RU 6220-22 } incl. hojas de sierra
 incl. lames
 RU 6220-24 } incl. lame per sega
 RU 6220-83, RU 6220-85



RU 6220-24
ECO-Version



RU 6220-51
 komplett mit Säge }
 complete with saw }
 completo con sierra }
 complet avec scie }
 completo e sega } **RU 6220-20**



RU 6220-80
RU 6220-81
RU 6220-82
RU 6220-83
RU 6220-84
RU 6220-85



RU 6220-86
RU 6220-87



RU 6220-88
RU 6220-89



RU 6220-91
RU 6220-92

| | Gips Plaster Yeso Plâtre Gesso | Synthetik Syntetic Material sintético Résine Materiale sintetico |
|---------|--|--|
| Ø 44 mm | RU 6220-80 | RU 6220-81 |
| Ø 50 mm | RU 6220-82 | RU 6220-83 |
| Ø 65 mm | RU 6220-84 | RU 6220-85 |
| Ø 65 mm | RU 6220-86 | RU 6220-87 |
| Ø 65 mm | RU 6220-88 | RU 6220-89 |
| Ø 70 mm | RU 6220-91 | RU 6220-92 |

Zubehör, Accessories, Accesorio, Accessoires, Accessori



RU 6220-40 (800 mAh)
RU 6220-41 (1700 mAh)

AKKU für }
 ACCU for }
 ACCU para } **RU 6220-22**
 ACCU pour }
 ACCU per }

| | | |
|-------------------|--|---|
| RU 6220-42 | Schnell-Ladegerät für Quick Recharger for Cargador para Chargeur pour Caricatore per | } RU 6220-40 RU 6220-41 |
| RU 6220-31 | Koffer für Case for Maleta para Valise pour Valigetta per | } RU 6220-20 RU 6220-24 |
| RU 6220-32 | Koffer für Case for Maleta para Valise pour Valigetta per | } RU 6220-22 |



Gipsabreißzangen, Gipsscheren
Plaster Instruments
Instrumental para vendajes enyesados
Pinces et cisailles pour les plâtres
Strumenti per apparecchi gessati

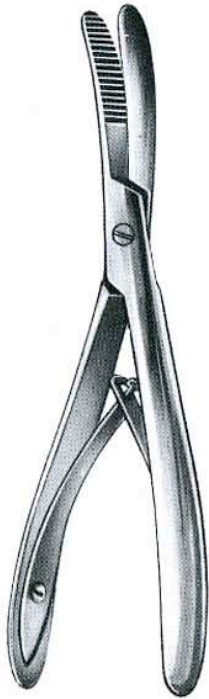

Wolff

18 cm/7" RU 6240-18
24 cm/9½" RU 6240-24

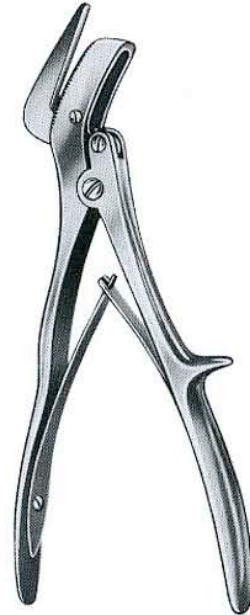

Stille

24 cm/9½" RU 2835-24



Stille

23 cm/9" RU 2840-23
26 cm/10¼" RU 2840-26
37 cm/14½" RU 2840-37



Tracheotomie
Tracheotomy
Traqueotomia
Trachéotomie
Tracheotomia



Tracheal Dilatatoren
Trachea dilators
Dilatadores para la tráquea
Dilatateurs pour la trachéotomie
Dilatatori per tracheotomia

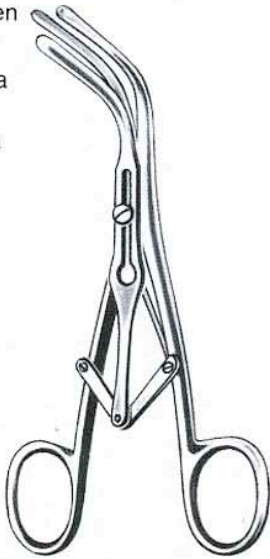

Laborde
13 cm/5" **RU 6250-13**
15 cm/6" **RU 6250-15**



Trousseau
14 cm/5 1/2"
RU 6251-14

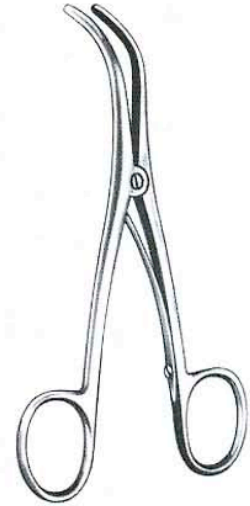

Trousseau-Baby
13 cm/5"
RU 6252-13

Trachealhaken
Trachea hooks
Ganchos para traqueotomia
Crochets pour trachéotomie
Ganci per tracheotomia

links
left
a la izquierda
à gauche
sinistra



Bose
7 cm/2 3/4"
RU 6253-07

rechts
right
a la derecha
à droite
destra



scharf
sharp
agudos
pointu
acuto

Bose
16 cm/6 1/4"
RU 6255-01 RU 6255-02

Schilddrüsenhaken
Thyroid gland retractor
Separador para la glándula tiroidea
Ecarteurs pour la thyroïde
Divaricatori per la tiroide



Schoenborn
21 cm/8 1/4"
RU 6257-21

Trachealtrokar
Trachea trocars
Trocares traqueales
Trocarts pour la trachéotomie
Trequarti per tracheotomia



Uckermann
13 cm/5"
8 mm Ø **RU 6259-08**
10 mm Ø **RU 6259-10**



Tracheal-Kanülen
Trachea Tubes
Cánulas traqueales
Canules pour la trachéotomie
Cannule tracheali



Internationale Größenskala / International scale / escala internacional / échelle internationale / scala internazionale

| Fig. | 0 | 1 | 2 | 3 | 4 | 5 | 6 | 7 | 8 | 9 |
|---|----|----|----|----|----|----|----|----|----|----|
| | | | | | | | | | | |
| Ø mm | 4 | 5 | 6 | 7 | 8 | 9 | 10 | 11 | 12 | 13 |
| Charr./Fr. | 12 | 15 | 18 | 21 | 24 | 27 | 30 | 33 | 36 | 39 |
| Länge des Außenrohrs length of outer tube largo de la cánula exterior longueur du tube extérieur lunghezza del tubo esterno | 45 | 50 | 55 | 60 | 65 | 70 | 75 | 80 | 85 | 90 |



Luer
 Standard-Modell
 Standard pattern
 modelo standard
 modèle standard
 modello standard

| Fig. | Ø mm | Neusilber (CuZnNi) German silver (CuZnNi) alpacca (CuZnNi) mailechort (CuZnNi) alpacca (CuZnNi) | Silber silver plata argent argento | NR-Stahl Stainless steel acero inoxidable acier inoxydable acciaio inossidabile |
|------|------|---|--|---|
| 0 | 4 | RU 6260-04 | RU 6260-04SI | RU 6260-04NR |
| 1 | 5 | RU 6260-05 | RU 6260-05SI | RU 6260-05NR |
| 2 | 6 | RU 6260-06 | RU 6260-06SI | RU 6260-06NR |
| 3 | 7 | RU 6260-07 | RU 6260-07SI | RU 6260-07NR |
| 4 | 8 | RU 6260-08 | RU 6260-08SI | RU 6260-08NR |
| 5 | 9 | RU 6260-09 | RU 6260-09SI | RU 6260-09NR |
| 6 | 10 | RU 6260-10 | RU 6260-10SI | RU 6260-10NR |
| 7 | 11 | RU 6260-11 | RU 6260-11SI | RU 6260-11NR |
| 8 | 12 | RU 6260-12 | RU 6260-12SI | RU 6260-12NR |
| 9 | 13 | RU 6260-13 | RU 6260-13SI | RU 6260-13NR |

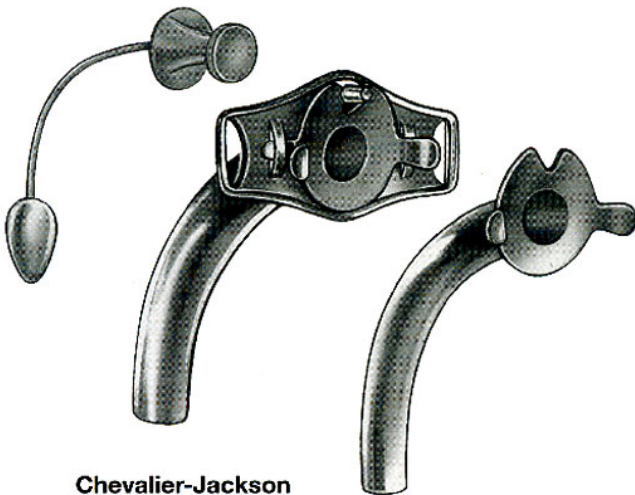

Chevalier-Jackson

| Fig. | Ø mm | Neusilber (CuZnNi) German silver (CuZnNi) alpacca (CuZnNi) mailechort (CuZnNi) alpacca (CuZnNi) | Silber silver plata argent argento | NR-Stahl Stainless steel acero inoxidable acier inoxydable acciaio inossidabile |
|------|------|---|--|---|
| 0 | 4 | RU 6265-04 | RU 6265-04SI | RU 6265-04NR |
| 1 | 5 | RU 6265-05 | RU 6265-05SI | RU 6265-05NR |
| 2 | 6 | RU 6265-06 | RU 6265-06SI | RU 6265-06NR |
| 3 | 7 | RU 6265-07 | RU 6265-07SI | RU 6265-07NR |
| 4 | 8 | RU 6265-08 | RU 6265-08SI | RU 6265-08NR |
| 5 | 9 | RU 6265-09 | RU 6265-09SI | RU 6265-09NR |
| 6 | 10 | RU 6265-10 | RU 6265-10SI | RU 6265-10NR |
| 7 | 11 | RU 6265-11 | RU 6265-11SI | RU 6265-11NR |
| 8 | 12 | RU 6265-12 | RU 6265-12SI | RU 6265-12NR |
| 9 | 13 | RU 6265-13 | RU 6265-13SI | RU 6265-13NR |

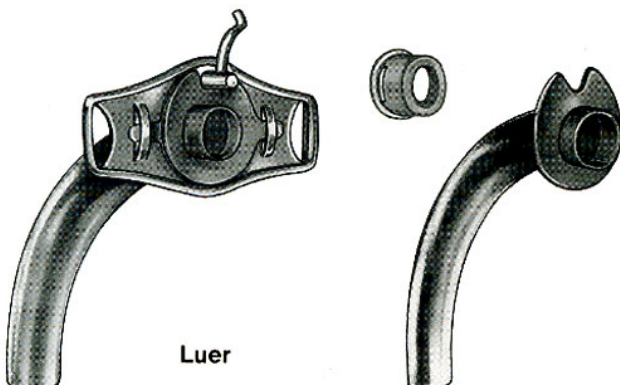

Luer

| Fig. | Ø mm | Neusilber (CuZnNi) / German silver (CuZnNi) alpacca (CuZnNi) / mailechort (CuZnNi) / alpacca (CuZnNi) |
|------|------|--|
| 4 | 8 | RU 6267-08 |
| 5 | 9 | RU 6267-09 |
| 6 | 10 | RU 6267-10 |
| 7 | 11 | RU 6267-11 |
| 8 | 12 | RU 6267-12 |
| 9 | 13 | RU 6267-13 |

Ventil-Sprechkanüle, Innenrohr mit arretierbarem Ventil.
 Value speaking tube, inner tube with locking valve.
 Cánulas parlantes interiores con tubo redondo en forma de caja
 Canules parlantes, tubes intérieurs avec soupape ronde
 Cannula parlante, tubo interno con valvola rotonda da attaccare



Tracheotomie-Besteck
Tracheotomy Set
Estuche para traqueotomia
Jeu d'instruments pour la trachéotomie
Set per tracheotomia

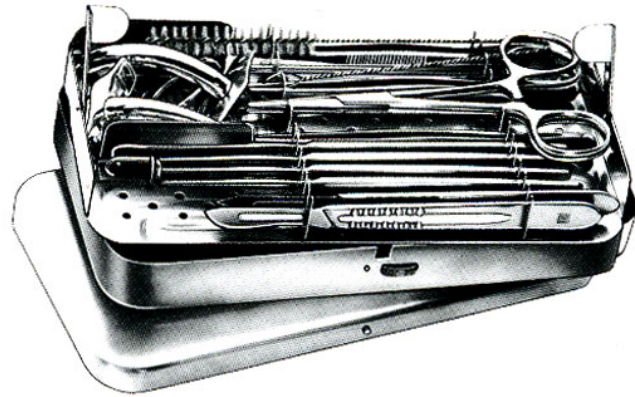

RU 6270-00

in Metall-Etui, bestehend aus:

- RU 4850-04 1 Griff und 1 Klinge Fig. 20
- RU 4850-04 1 Griff und 1 Klinge Fig. 23
- RU 4000-13 1 anat. Pinzette 13 cm
- RU 4100-13 2 chir. Pinz. 13 cm, 1 x 2 Zähne
- RU 3020-13 2 Pean-Klemmen, 13 cm
- RU 4910-13 1 Hohlsonde 13 cm
- RU 6253-07 1 Trachealdilatator
- RU 4471-02 2 Trachealhäkchen Iterson stumpf
- RU 6255-01 1 Trachealhäkchen Bose scharf, links
- RU 6255-02 1 Trachealhäkchen Bose scharf, rechts
- RU 6260-07 1 Trachealkanüle Luer Standard, Fig. 3
- RU 6260-08 1 Trachealkanüle Luer Standard, Fig. 4
- RU 6271-00 1 Reinigungsbürste

in metal case, consisting of:

- RU 4850-04 1 handle with 1 blade, Fig. 20
- RU 4850-04 1 handle with 1 blade, Fig. 23
- RU 4000-13 1 dressing forceps, 5"
- RU 4100-13 2 tissue forceps, 5", 1 x 2 teeth
- RU 3020-13 2 Pean artery forceps, 5"
- RU 4910-13 1 grooved director, 5"
- RU 6253-07 1 trachea dilator
- RU 4471-02 2 Iterson trachea retractors, blunt
- RU 6255-01 1 Bose trachea retractor, sharp, left hand side
- RU 6255-02 1 ditto, right hand side
- RU 6260-07 1 Luer trachea tubes, standard
- RU 6260-08 1 Luer trachea tube, standard, Fig. 4
- RU 6271-00 1 cleaning brush

en boîte métallique, consistant en:

- RU 4850-04 1 manche de bistouri et 1 lame fig. 20
- RU 4850-04 1 manche de bistouri et 1 lame fig. 23
- RU 4000-13 1 pince à dissection, 13 cm
- RU 4100-13 2 pinces à griffes, 13 cm, 1 x 2 dents
- RU 3020-13 2 pinces hémostatiques Péan, 13 cm
- RU 4910-13 1 sonde cannelée, 13 cm
- RU 6253-07 1 dilatateur trachéal
- RU 4471-02 2 crochets trachéaux Iterson, mousses
- RU 6255-01 1 crochet trachéal Bose, pointu, à gauche
- RU 6255-02 1 crochet trachéal Bose, pointu, à droite
- RU 6260-07 1 canule trachéale Luer, standard, Fig. 3
- RU 6260-08 1 canule trachéale Luer, standard, Fig. 4
- RU 6271-00 1 brosse à nettoyer

en estuche de metal, compuesto de:

- RU 4850-04 1 mango con 1 hoja fig. 20
- RU 4850-04 1 mango con 1 hoja fig. 23
- RU 4000-13 1 pinza de disección
- RU 4100-13 2 pinza de disección, con 1 x 2 dientes, 13 cm
- RU 3020-13 2 Pean pinzas hemostáticas, 13 cm
- RU 4910-13 2 sonda acanalada, 13 cm
- RU 6253-07 1 dilatador traqueal
- RU 4471-02 2 Iterson separadores traqueales, romos
- RU 6255-01 1 Bose separador traqueal, agudo, lado izquierdo
- RU 6255-02 1 idem, lado derecho
- RU 6260-07 1 Luer cánula traqueal, modelo standard, Fig. 3
- RU 6260-08 1 Luer cánula traqueal modelo standard, Fig. 4
- RU 6271-00 1 cepillo de limpieza

in scatola di metallo, contenente:

- RU 4850-04 1 manico di bisturi con 1 lama fig. 20
- RU 4850-04 1 manico di bisturi con 1 lama fig. 23
- RU 4000-13 1 pinza per dissezione, 13 cm
- RU 4100-13 2 pinze per dissezione con denti 1 x 2, 13 cm
- RU 3020-13 2 pinze emostatiche Pean, 13 cm
- RU 4910-13 2 sonda scanalata, 13 cm
- RU 6253-07 1 dilatatore tracheale
- RU 4471-02 2 uncini tracheali Iterson, smussi
- RU 6255-01 1 uncino tracheale Bose, acuto, lato sinistro
- RU 6255-02 1 uncino tracheale Bose, acuto, lato destra
- RU 6260-07 1 cannula tracheale Luer, standard, Fig. 3
- RU 6260-08 1 cannula tracheale Luer, standard, Fig. 4
- RU 6271-00 1 spazzolino per pulire



Kropf
Goitre
Bocio
Goitre
Gozzo



Kropfsonden
Goitre probes
Sondas para bocio
Sondes à goitre
Sonde per gozzo

Kocher

15 cm/6" **RU 6277-15**
16 cm/6¹/₄" **RU 6277-16**



Kropffaßzangen
Goitre grasping forceps
Pinzas coger-bocio
Pinces à goitre
Pinze per gozzo

Lahey

15 cm/6" **RU 6280-15**
20 cm/8" **RU 6280-20**

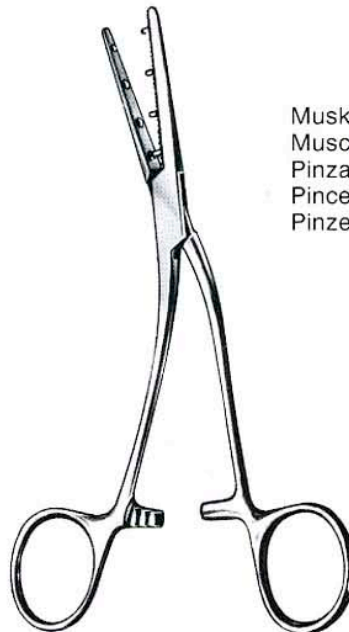

Muskelklemme
Muscle forceps
Pinzas musculares
Pinces à muscles
Pinze per muscoli

Mastin

17 cm/6³/₄"
RU 6281-17

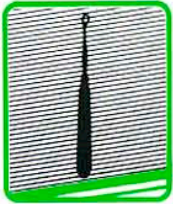

Dermatologie
Dermatology
Dermatologia
Dermatologie
Dermatologia



Komedonenquetscher
Comedone extractors
Saca comedones
Tire-comédons
Schiaccia comedoni



Schamberg
 10 cm/4"
 RU 6284-10

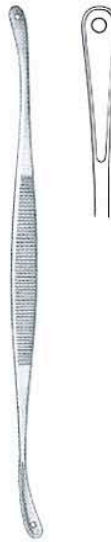

Unna
 14 cm/5 1/2"
 RU 6286-14



Unna
 14 cm/5 1/2"
 RU 6287-14



Saalfeld
 10 cm/4"
 RU 6288-10



Saalfeld
 14 cm/5 1/2"
 RU 6288-14



Hebra
 18 cm/7"
 RU 6288-18



Piffard
 14,5 cm/5 3/4"

Hautküretten
Skin curettes
Curetas cutaneas
Curettes dermatologiques
Curette cutanee



Fig. 1 **RU 6289-01**



Fig. 2 **RU 6289-02**



Fig. 3 **RU 6289-03**



Dermatologie
 Dermatology
 Dermatologia
 Dermatologie
 Dermatologia

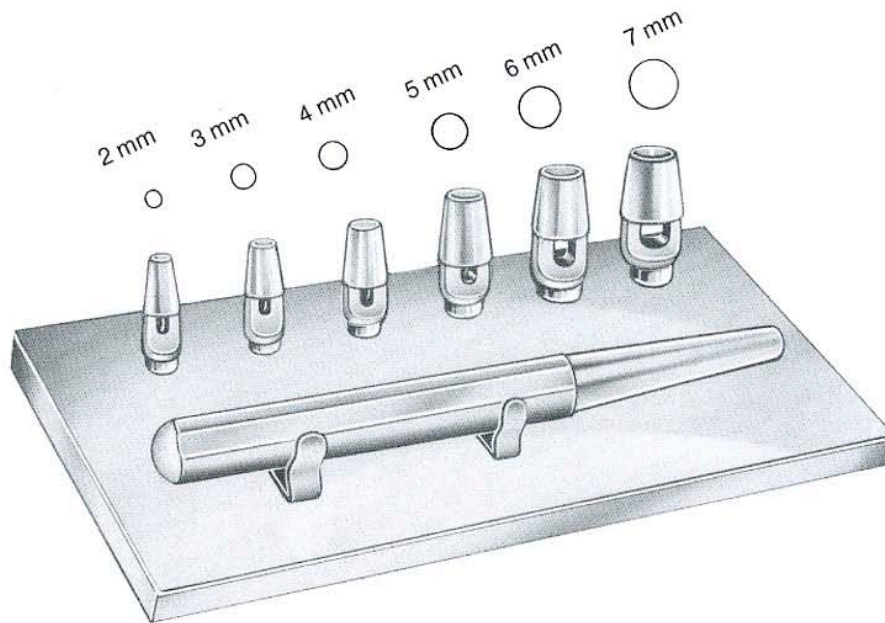

Keyes

RU 6290-00

Satz Hautstanzen komplett, mit 6 auswechselbaren Aufsätzen
 set of dermal punches, complete with 6 interchangeable tips
 juego de trépanos de dermatologia con 6 puntas intercambiables
 jeu d'emporte-pièces dermatologiques avec 6 embouts interchangeables
 serie completa di trefine con 6 trefine intercambiabili

Haut-Trephinen
 Cutaneous punches
 Trépanos cutáneos
 Trépanos cutanés
 Trefine cutanee



10 cm/4"

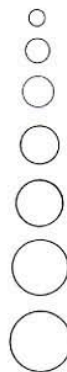

| mm Ø | Keyes |
|---------|------------|
| 2 | RU 6290-02 |
| 3 | RU 6290-03 |
| 4 | RU 6290-04 |
| 5 | RU 6290-05 |
| 6 | RU 6290-06 |
| 7 | RU 6290-07 |
| 8 | RU 6290-08 |

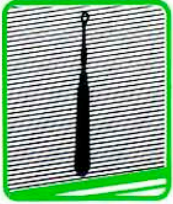

Lupuslöffel
 Lupus curettes
 Curetas para lupus
 Curettes pour le lupus
 Curette per lupus

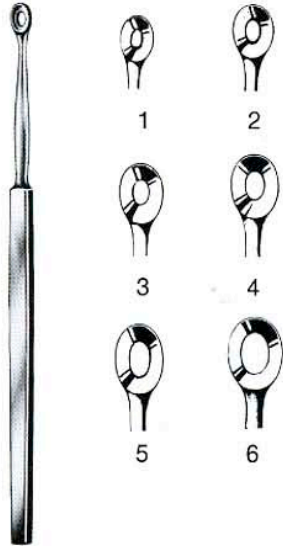

Wolff
 14 cm/5 1/2"

- Fig.
- 1 RU 6291-01
 - 2 RU 6291-02
 - 3 RU 6291-03
 - 4 RU 6291-04
 - 5 RU 6291-05
 - 6 RU 6291-06

Lupusküretten
 Lupus curettes
 Curetas para lupus
 Curettes pour le lupus
 Curette per lupus

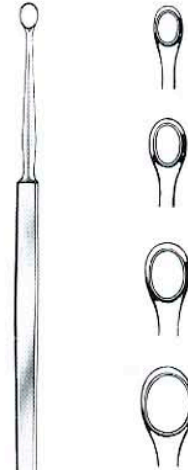

Fox
 14 cm/5 1/2"

Lupusschaber
 Lupus scraper
 Legra para lupus
 Rugine pour le lupus
 Raschiatoio per lupus



Vidal
 14 cm/5 1/2"
 RU 6293-14

Moncorpsmesser
 Moncorps knife
 Cuchillo moncorps
 Couteau moncorps
 Coltello moncorps



Moncorps
 14 cm/5 1/2"
 RU 6294-14

Hauthäkchen
 Cutaneous hook
 Ganchos cutáneos
 Erignes cutanées
 Uncini cutanei



Gillies
 18 cm/7"
 Fig. 1 RU 6296-01
 Fig. 2 RU 6296-02



Kilner
 15 cm/6"
 RU 6297-15