

**Gefäßinstrumente
Vessel Instruments
Instrumental vascular
Instruments pour vaisseaux
Strumenti vascolari**

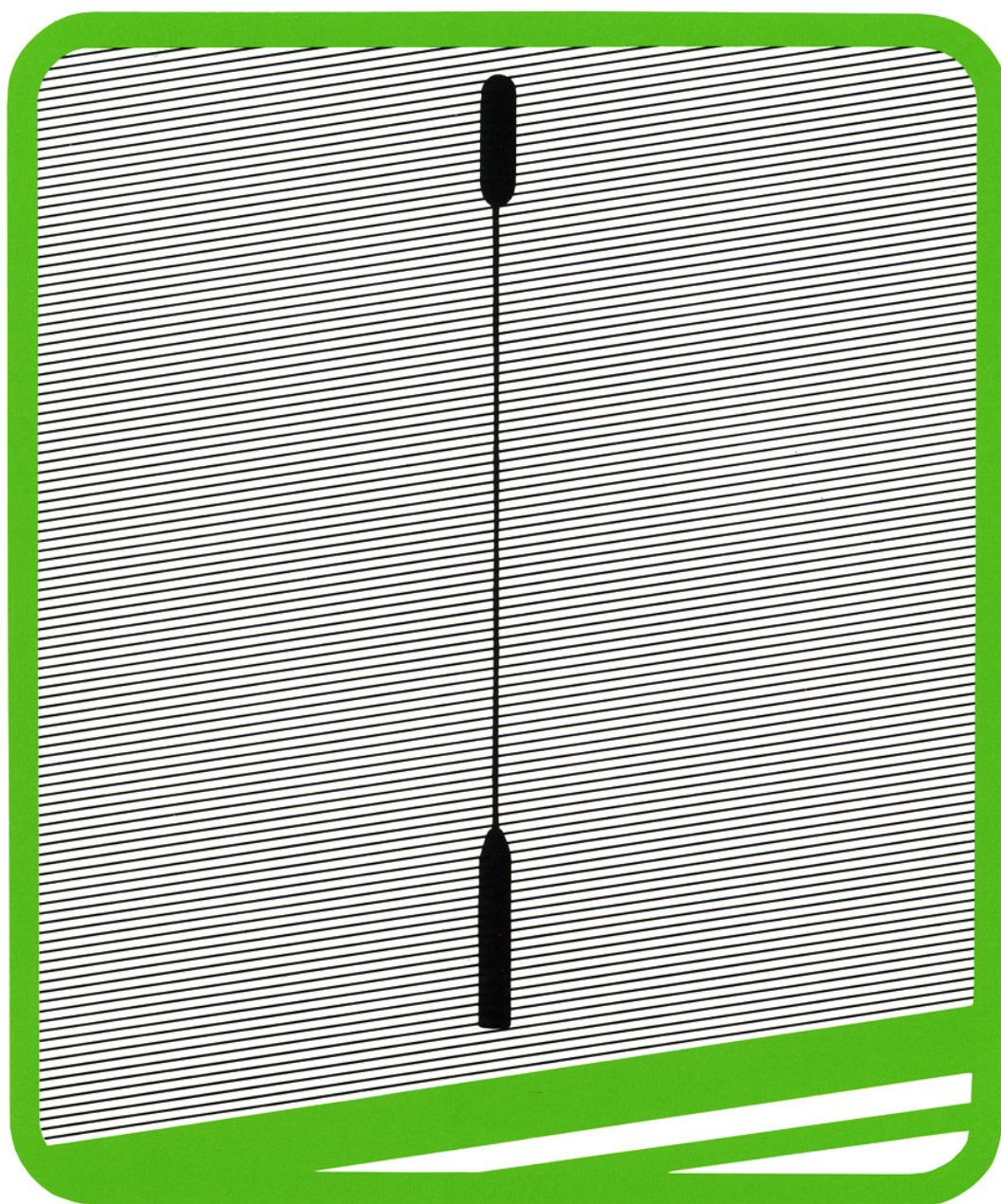



**Venenstripper-Besteck, Venenstripper
Vein Stripper Set, Vein Strippers
Juego para várices, Sondas para várices
Trousse à veines, Cordes veineuses
Astuccio per le vene, Sonde per vene**



Venenstripper-Besteck in Metalletui
Vein stripper set in metal case
Juego para várices en estuche de metal
Trousse à veines en boîte métallique
Astuccio per le vene in scatola in metallo

Ersatzteile für RU 4950-00
Spare parts for RU 4950-00
Piezas de repuesto
Pièces de rechange pour RU 4950-00
Pezzi di ricambio

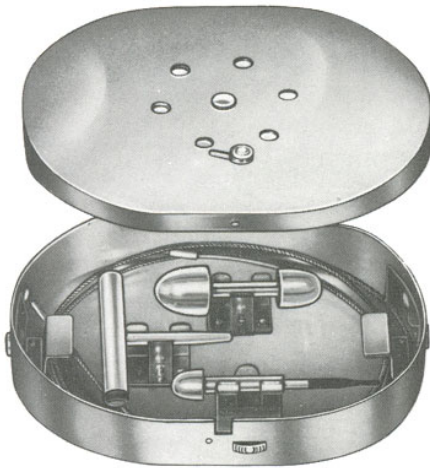

Nabatoff
135 x 100 x 25 mm
RU 4950-00

sterilisierbar
sterilizable
esterilizable
stérilisable
sterilizzabile



RU 4950-11

RU 4950-10

100 cm/36½"
RU 4950-12

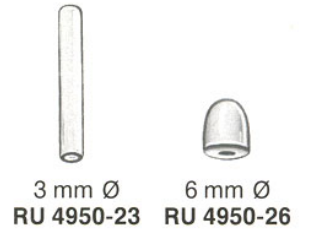

3 mm Ø
RU 4950-23

6 mm Ø
RU 4950-26

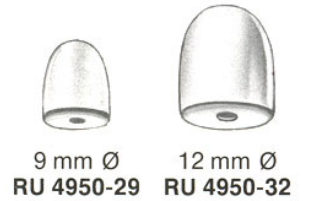

9 mm Ø
RU 4950-29

12 mm Ø
RU 4950-32



15 mm Ø
RU 4950-35

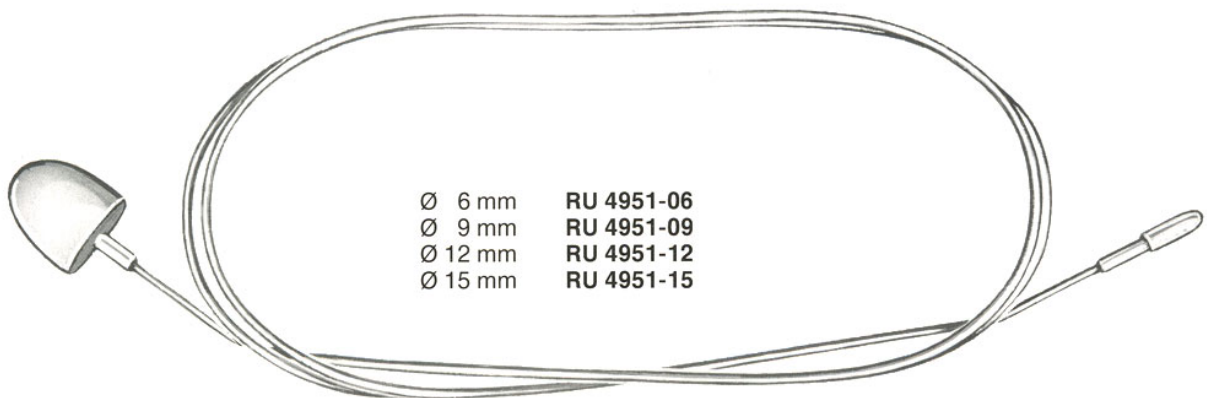

Ø 6 mm RU 4951-06
Ø 9 mm RU 4951-09
Ø 12 mm RU 4951-12
Ø 15 mm RU 4951-15

Myers



Endarterektomie, Varizeninstrumente
Endarterectomy, Varix Instruments
Endarterectomia, Instrumental para várices
Endartérectomie, Instruments pour les varices
Endarterectomia, Strumenti per varici



Endarterektomiestripper
 Endarterectomy strippers
 Sondas para endarterectomia
 Sondes pour endartérectomie
 Sonde per endarterectomia



Ø
mm
2
3
4
6
7
8,5
10
12
14

RU 4952-02 Gefäß-Spülkanülen
RU 4952-03 Vessel irrigating cannulas
RU 4952-04 Cánulas de irrigación para vasos
RU 4952-06 Canules d'irrigation pour vaisseaux
RU 4952-07 Canules d'irrigation pour vaisseaux
RU 4952-08 Canules d'irrigation pour vaisseaux
RU 4952-10 Canule per irrigazione per varici
RU 4952-12 Canule per irrigazione per varici
RU 4952-14 Canule per irrigazione per varici

Ø 3 mm

Ø 4 mm



RU 4954-03

RU 4954-04

Ø 5 mm

Ø 6 mm



RU 4954-05

RU 4954-06

Griff für
 Handle for
 Mango para
 Manche pour
 Manico per

RU 4952-02 – RU 4952-14

RU 4952-00

Schmid

55 cm/21½"

Phlebodissektor
 Phlebodissector
 Disector para venas
 Phlébo-dissecteur
 Flebo-dissettori

Phlebextraktoren
 Phlebextractors
 Extractores para venas
 Phlébo-extracteurs
 Flebe-estrattore

Mikro-Doppelspatel
 Micro spatula
 Micro-espátulas
 Micro-spatules
 Micro-spatole doppie

Mikro-Phlebextraktor
 Micro phlebextractor
 Micro-extractores para venas
 Micro-phlébo-extracteurs
 Micro-flebo-estrattore

Mini-Phlebextraktor
 Mini phlebextractor
 Mini-extractores para venas
 Mini-phlébo-extracteurs
 Mini-flebo-estrattore



Varady
 18 cm/7"
RU 4956-01

Varady
 18 cm/7"
RU 4956-02

Varady
 18 cm/7"
RU 4956-03

Varady
 17 cm/6¾"
RU 4956-04

Varady
 17 cm/6¾"
RU 4956-05

Varady
 17 cm/6¾"
RU 4956-06



Gefäßspatel
Vessel Spatulas
Espátulas vasculares
Spatules pour les vaisseaux
Spatole vascolari



5 mm
 14 cm/5½"
RU 4955-03/14

Schmid

24 cm/9¼"
RU 4955-03/24



23 cm/9"
RU 4955-05/23



15 cm/6"
RU 4955-10/15



21 cm/8¼"
RU 4955-10/21



Davis
 24,5 cm/9¾"
RU 6342-24



Rechtshänder
 Right-handed
 Para diestros
 Pour droitier
 Per destrimani

Set à 3 Haken
 Set of 3 hooks
 Set de 3 ganchos
 Set de 3 crockets
 Set di 3 uncini
RU 4956-21, -22, -23

RU 4956-20



Linkshänder
 Left-handed
 Para zurdos
 Pour gaucher
 Per mancini

Set à 3 Haken
 Set of 3 hooks
 Set de 3 ganchos
 Set de 3 crockets
 Set di 3 uncini
RU 4956-31, -32, -33

RU 4956-30



Toennis
 25 cm/10"



RU 6344-25



RU 6344-25/01

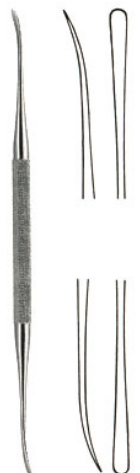

Freer
 18 cm/7"
RU 8216-18



Gefäßspatel, Gefäßhäkchen
Vessel Spatula, Vessel Hooks
Espátulas vasculares, Ganchitos vasculares
Spatules et crochets pour les vaisseaux
Spatole ed uncini vascolari

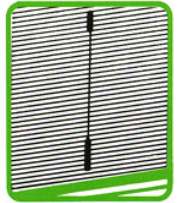

Halle
 16,5 cm/6½"
RU 8204-16

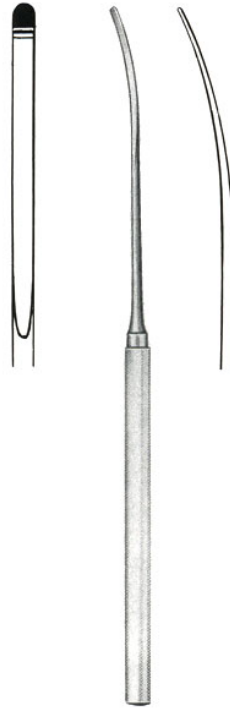

3 mm
 stumpf
 blunt
 romos
 mousse
 smusso

18,5 cm/7" **RU 8850-01**
 21,5 cm/8½" **RU 8850-02**



Crile
 20 cm/8"
RU 4425-20



Cushing
 19 cm/7½"



RU 4426-01



RU 4426-02



Krayenbühl
 18,5 cm/7½"
RU 8825-06



RU 8825-07



RU 8825-08



RU 8825-09



Aorta Dilatoren, Aortenstanzen
Aortic Dilators, Aortic Punches
Dilatadores de aorta, Punzonadoras aorticas
Dilatateurs aortiques, Emporte-pièces aortiques
Dilatatori vascolari, Punzonatrice vascolari

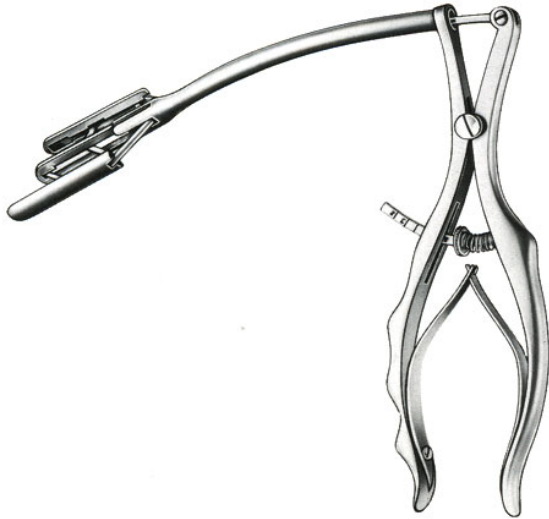

Cooley
RU 7761-00



Gerbode
RU 7762-00



Tubbs
RU 7763-00

zerlegbar
 detachable
 desmontable
 démontable
 smontabile

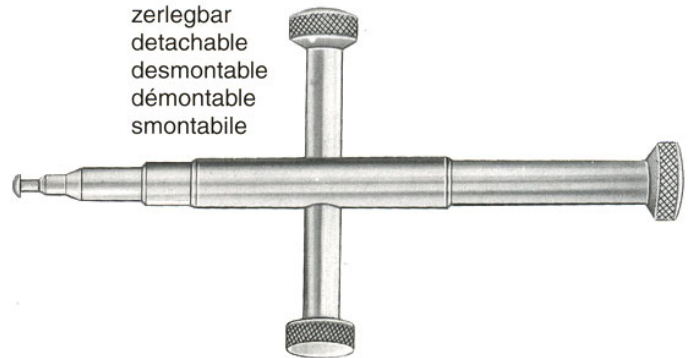

| Länge length largo longueur lunghezza | Ø mm | |
|---|------|-------------------|
| 12 cm/4¾" | 3 | RU 7765-03 |
| 12 cm/4¾" | 4 | RU 7765-04 |
| 12 cm/4¾" | 5 | RU 7765-05 |
| 12 cm/4¾" | 6 | RU 7765-06 |
| 15 cm/6" | 3 | RU 7765-13 |
| 15 cm/6" | 4 | RU 7765-14 |
| 15 cm/6" | 5 | RU 7765-15 |
| 15 cm/6" | 6 | RU 7765-16 |



Embolusfaßzangen, Gefäß-Dilatatoren
Embolus Grasping Forceps, Vascular Dilators
Pinzas para coger émbolos, Dilatadores vasculares
Pinces à saisir le caillot, Dilatateurs vasculaires
Pinza per afferrare ad embolia, Dilatatori vascolari

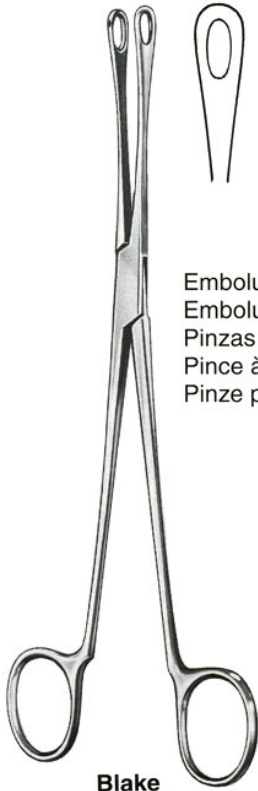
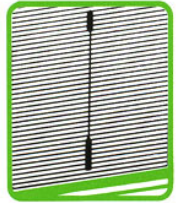

Embolusfaßzange
 Embolus grasping forceps
 Pinzas para coger émbolos
 Pince à saisir le caillot
 Pinze per afferrare ad embolia

Blake
 20 cm/8"
 RU 6650-20



De Bakey

| mm Ø | 19 cm/7 1/2" | 35 cm/14" |
|------|--------------|------------|
| 0,5 | RU 7770-05 | RU 7771-05 |
| 1,0 | RU 7770-10 | RU 7771-10 |
| 1,5 | RU 7770-15 | RU 7771-15 |
| 2,0 | RU 7770-20 | RU 7771-20 |
| 2,5 | RU 7770-25 | RU 7771-25 |
| 3,0 | RU 7770-30 | RU 7771-30 |
| 3,5 | RU 7770-35 | RU 7771-35 |
| 4,0 | RU 7770-40 | RU 7771-40 |
| 4,5 | RU 7770-45 | RU 7771-45 |
| 5,0 | RU 7770-50 | RU 7771-50 |
| 7,0 | RU 7770-70 | RU 7771-70 |
| 9,0 | RU 7770-90 | RU 7771-90 |

biegsam
 flexible
 maleables
 souples
 malleabili

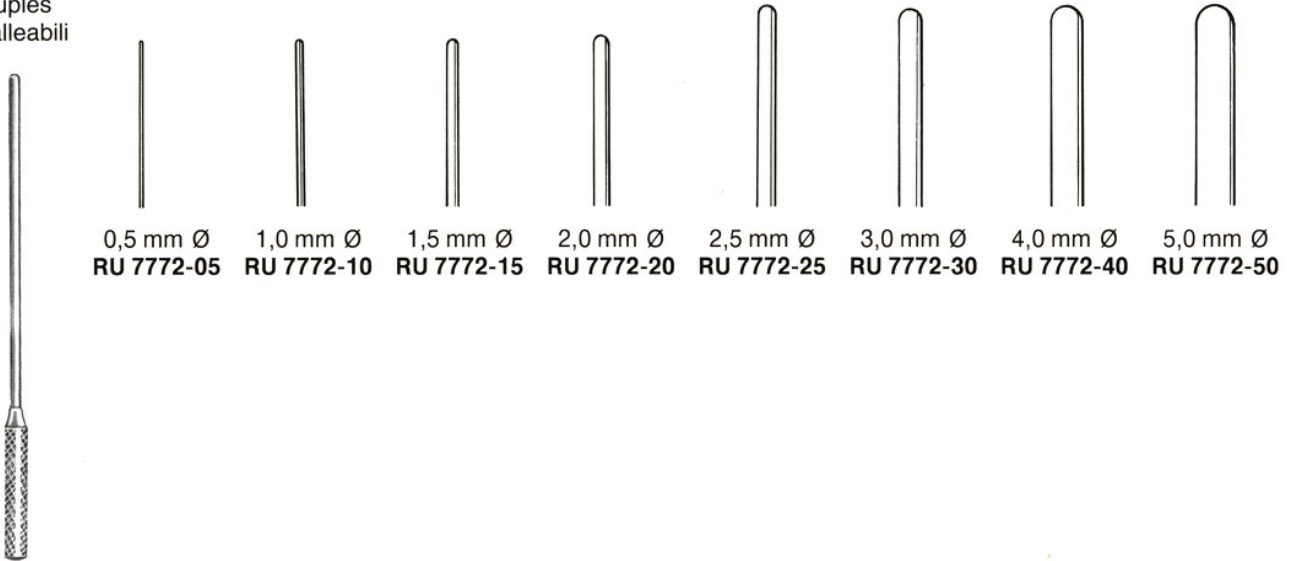

0,5 mm Ø RU 7772-05 1,0 mm Ø RU 7772-10 1,5 mm Ø RU 7772-15 2,0 mm Ø RU 7772-20 2,5 mm Ø RU 7772-25 3,0 mm Ø RU 7772-30 4,0 mm Ø RU 7772-40 5,0 mm Ø RU 7772-50

Cooley
 13 cm/5"



Gefäß-Dilatatoren
Vascular Dilators
Dilatadores vasculares
Dilatateurs vasculaires
Dilatatori vascolari



biegsam
malleable
maleables
souples
malleabili



Garrett

| mm Ø | 14 cm/5½" | 21 cm/8¼" |
|------|-------------------|-------------------|
| 1,0 | RU 7773-00 | RU 7773-18 |
| 1,5 | RU 7773-02 | RU 7773-20 |
| 2,0 | RU 7773-04 | RU 7773-22 |
| 2,5 | RU 7773-06 | RU 7773-24 |
| 3,0 | RU 7773-08 | RU 7773-26 |
| 3,5 | RU 7773-10 | RU 7773-28 |
| 4,0 | RU 7773-12 | RU 7773-30 |
| 4,5 | RU 7773-14 | RU 7773-32 |
| 5,0 | RU 7773-16 | RU 7773-34 |
| Satz | RU 7773-36 | RU 7773-38 |



Saugkanülen
Aspiration Cannulas
Cánulas de aspiración
Canules d'aspiration
Tubi d'aspirazione





RU 5260-01 ▶
Yankauer
 27 cm/10 1/2"
RU 5260-27



Finsterer
 30 cm/12"
RU 5266-15

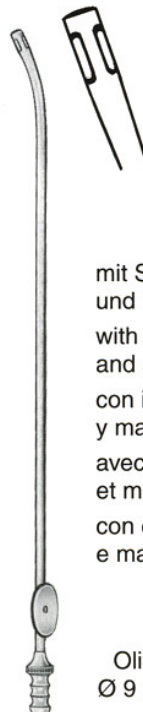

Ø 9 mm
 mit zentraler Bohrung, Ø 3,0 mm und seitlichen Schlitz
 with central bore, 3.0 mm diam. and lateral slots
 con perforación central Ø 3,0 mm y hendidura lateral
 avec perçage central Ø 3,0 mm et taillades latérales
 con perforazione centrale Ø 3,0 mm scanalatura laterale
 Olive
 Ø 6 – 10 mm
DeBakey
 27,5 cm/10 1/2"
RU 5267-01



Ø 5 mm
 mit Saugunterbrecher und Mandrin
 with finger cut-off and stylet
 con interrupción de succión y mandril
 avec contrôle d'aspiration et mandrin
 con controllo di aspirazione e mandrino
 Olive
 Ø 9 mm
DeBakey
 16 cm/ 6 1/4" **RU 5268-16**
 27 cm/10 3/4" **RU 5268-27**



Frazier
 mm Ø Charr./Fr.
 2 6 **RU 6420-06**
 2 1/3 7 **RU 6420-07**
 2 2/3 8 **RU 6420-08**
 3 9 **RU 6420-09**
 3 1/3 10 **RU 6420-10**
 3 2/3 11 **RU 6420-11**
 4 12 **RU 6420-12**
 5 15 **RU 6420-15**

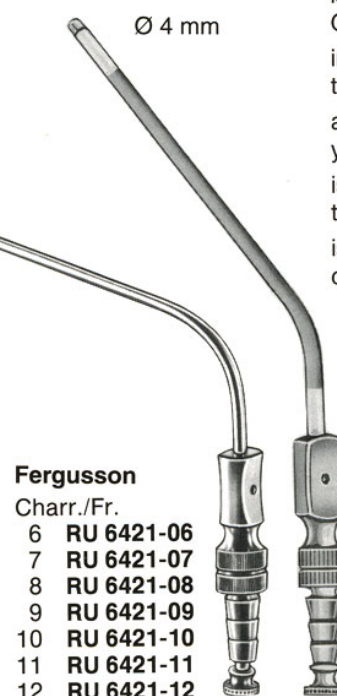

Ø 4 mm
 isoliert, mit Saugunterbrecher und Mandrin, Griffplatte 90° zur Biegung, LUER-Bohrung
 insulated, with finger cut-off and stylet, thumb piece 90° to curve, with LUER hub
 aislada con interrupción de succión y mandril, pieza 90° de curvatura, perforación LUER
 isolée, avec contrôle d'aspiration et mandrin, touche 90° à la courbure, perçage LUER
 isolato, con controllo di aspirazione, tasto 90° sulla curva, con mandrino perforazione LUER
 Olive
 Ø 6 – 9 mm
Fergusson
 18 cm/7 1/2"
RU 6421-34

Fergusson
 Charr./Fr.
 6 **RU 6421-06**
 7 **RU 6421-07**
 8 **RU 6421-08**
 9 **RU 6421-09**
 10 **RU 6421-10**
 11 **RU 6421-11**
 12 **RU 6421-12**

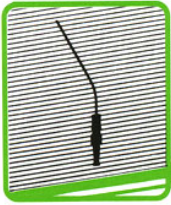

Saugrohre, Tourniquets
 Suction Tubes, Tourniquets
 Cánulas de aspiración, Tourniquetes
 Canules d'aspiration, Tourniquets
 Tubi d'aspirazione, Tornichetti

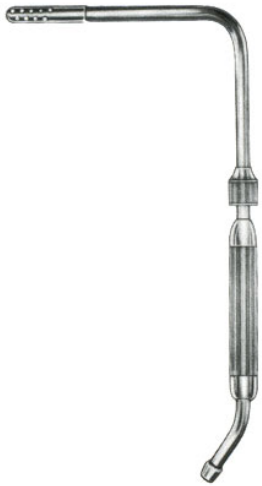

Cooley
 25 cm/10"
 RU 7780-01



Cooley
 33 cm/13"
 RU 7780-02



Cooley
 30 cm/12"
 RU 7780-03



Cooley
 30 cm/12"
 RU 7780-04



Cooley
 35 cm/13³/₄"
 RU 7780-05

Tourniquets
 Tourniquets
 Tourniquetes
 Tourniquets
 Tornichetti



Rumel-Belmont
 3,2 mm Ø RU 7787-32
 6,4 mm Ø RU 7787-64