

ADENOTOMIE TONSILLEKTOMIE

ADENOTOMY TONSILLECTOMY

Seiten 319 - 346

Pages 319 - 346



Übersicht

Scheren, Wundhaken, Ringmesser
Adenotome, Mundsperrer, Bruststützen
Zungendrücker, -spatel
Zungenzangen, Fingerschützer
Tamponstopfer, -zangen
Tonsillennadeln, -messer, -zangen
Ligatur-Instrumente
Elevatoren, Fasszangen, Klemmen
Tonsillenschnürer, Tonsillotome
Conchotome, Kompressorium

Overview

Scissors, retractors, adenoid curettes
Adenotomes, mouth gags, chest support
Tongue depressors
Tongue holding forceps, finger protector
Gauze packers, sponge holding forceps
Tonsil needles, -knives, -forceps
Ligature instruments
Dissectors, grasping-, haemostatic forceps
Tonsil snares, tonsillotomes
Punches, compressor

Seiten / Pages

320-323
323-332
332-334, 328-329
334
335, 337
335, 337-338
336
338-341
342-344
345

**PRÄPARIERSCHEREN, TONSILLEN SCHEREN
DISSECTING SCISSORS, TONSIL SCISSORS**



Metzenbaum-Fino
18 cm/7"
RU 1330-18
20 cm/8"
RU 1330-20



Metzenbaum-Fino
RU 1336-18
RU 1336-20



Metzenbaum
RU 1331-18
RU 1331-20



Metzenbaum
RU 1334-18



11 cm/4½"
RU 1706-10
Speichelgangschere
Salival scissors



Böttcher
18 cm/7"
RU 1810-18



Good
19 cm/7½"
RU 1845-19

**WUNDHAKEN, RINGMESSER
RETRACTORS, ADENOID CURETTES**

18 x 22 mm



17 x 16 mm
Baby-Roux
13 cm/5"
RU 4492-13



Middeldorpf



14 x 17 mm
21,5 cm/8½"
RU 4551-01



20 x 22 mm
22 cm/8¾"
RU 4551-02



26 x 30 mm
23,5 cm/9¼"
RU 4551-03



Bruenings-Brunk
22,5 cm/8¾"
RU 8363-19
Kieferhöhlenhaken
Antrum retractor



Beckmann
22 cm/8¾"

RU 8350-01

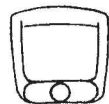

RU 8351-01

RU 8350-02



RU 8351-02

RU 8350-03



RU 8351-03

RU 8350-04



RU 8351-04

RU 8350-05



RU 8351-05

RU 8350-06



RU 8351-06

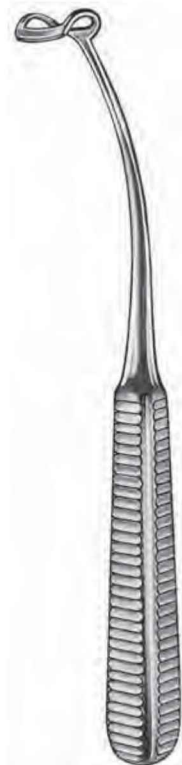

Negus
20 cm/8"

**RINGMESSER
ADENOID CURETTES**



Barnhill
20 cm/8"

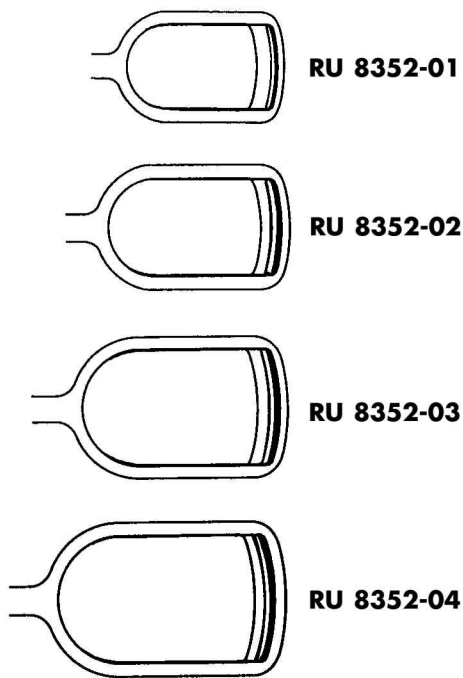

Beckmann
20 cm/8"

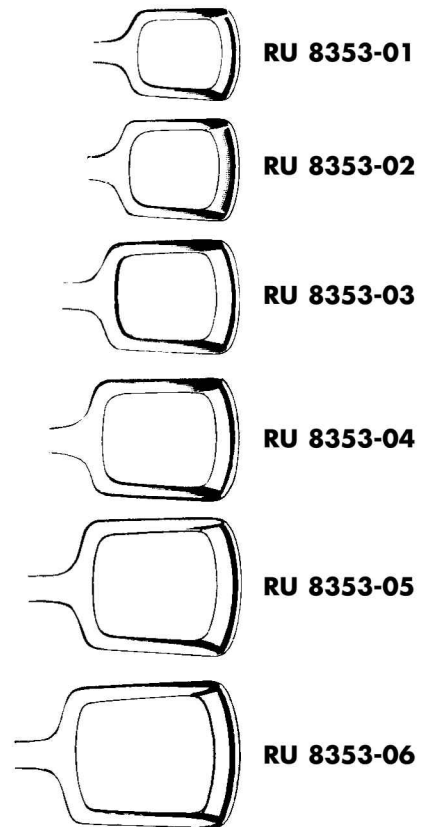

St. Clair-Thompson
22 cm/8¾"
Ringmesser mit Fangkorb
Adenoid currettes with cage

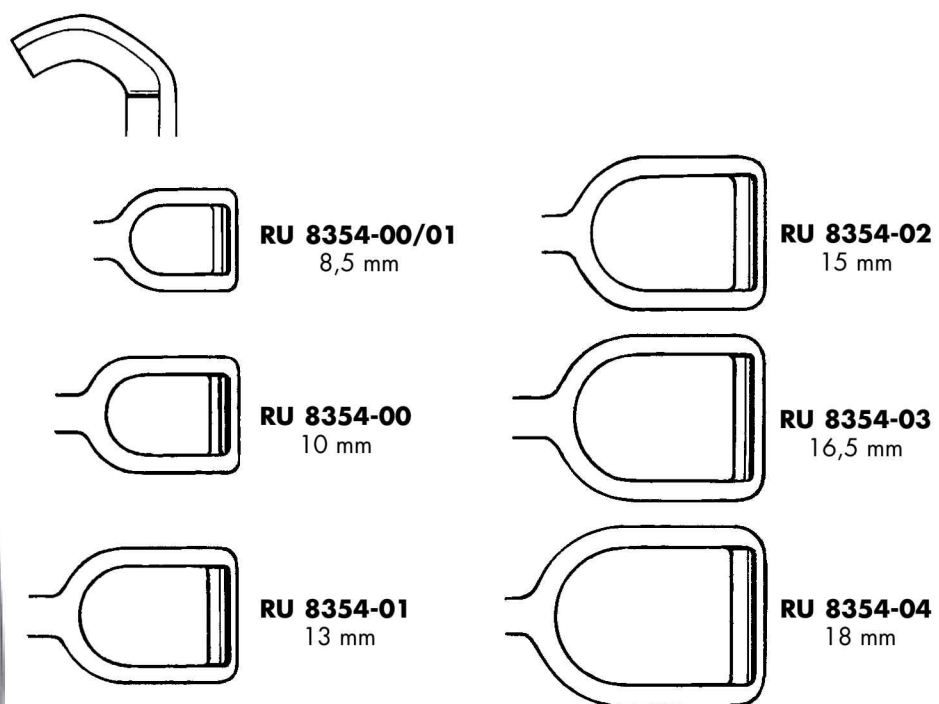

**RINGMESSER, ADENOTOME
ADENOID CURETTES, ADENOTOMES**



6 x 10 mm
RU 8355-01
Baby/baby

8 x 15 mm
RU 8355-02
Kinder/children

10 x 20 mm
RU 8355-03
Erwachsene/adults

Jones
21,5 cm/8½"



La Force
23 cm/9"

- Fig. 0 **RU 8361-00**
- Fig. 1 **RU 8361-01**
- Fig. 2 **RU 8361-02**
- Fig. 3 **RU 8361-03**



Fig. 0
8 mm



Fig. 1
12 mm



Fig. 2
16 mm



Fig. 3
18 mm



Shambaugh
21 cm/8¼"

- Fig. 1 **RU 8362-01**
- Fig. 2 **RU 8362-02**
- Fig. 3 **RU 8362-03**

Ersatzklingen für/
Spare blades for
RU 8361-.../RU 8362-...



- Fig. 0 **RU 8361-10**
- Fig. 1 **RU 8361-11**
- Fig. 2 **RU 8361-12**
- Fig. 3 **RU 8361-13**

**MUNDSPERRER
MOUTH GAGS**



Kilner-Doughty

komplett mit 3 Spateln Fig. 1–3
complete with 3 tongue-blades Fig. 1–3
RU 8380-00

Sperrer allein
Gag only
RU 8380-10

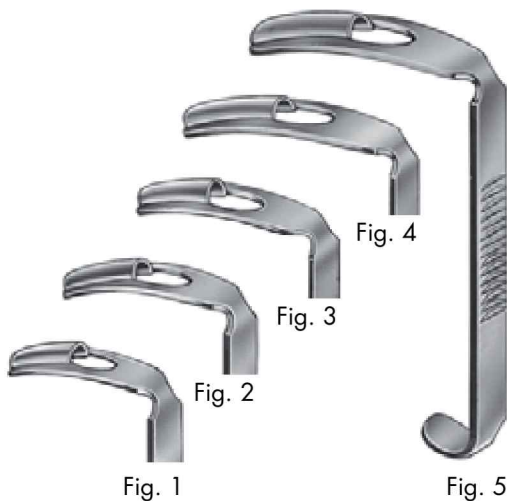

Zungenspatel/Tongue blades

Fig. 1 28 x 65 mm **RU 8380-01**
Fig. 2 32 x 75 mm **RU 8380-02**
Fig. 3 37 x 80 mm **RU 8380-03**
Fig. 4 41 x 94 mm **RU 8380-04**
Fig. 5 46 x 103 mm **RU 8380-05**

extra schmale Modelle/narrow pattern

Fig. 1 18 x 57 mm **RU 8380-11**
Fig. 2 22 x 67 mm **RU 8380-12**
Fig. 3 25 x 75 mm **RU 8380-13**

Alle auf den Seiten 324-329 abgebildeten Griffe und Spatel sind untereinander austauschbar.
All the frames and blades illustrated on page 324 to 329 are interchangeable.

**MUNDSPERRER
MOUTH GAGS**



Davis-Meyer

komplett mit 7 Spateln
complete with 7 tongue blades
Fig. 1 bis/to 7
RU 8381-00

Sperrer allein
Gag only
RU 8381-10



RU 8381-11
Gaumenplatte
Palate blade

- | | | |
|--------|---------------|-------------------|
| Fig. 1 | 29,0 x 70 mm | RU 8381-01 |
| Fig. 2 | 30,5 x 75 mm | RU 8381-02 |
| Fig. 3 | 31,5 x 80 mm | RU 8381-03 |
| Fig. 4 | 32,5 x 85 mm | RU 8381-04 |
| Fig. 5 | 33,5 x 95 mm | RU 8381-05 |
| Fig. 6 | 33,8 x 100 mm | RU 8381-06 |
| Fig. 7 | 34,0 x 105 mm | RU 8381-07 |

Zungenspatel mit doppeltem Ätherrohr
Tongue blades with anesthetic tubes on both sides

**MUNDSPERRER
MOUTH GAGS**

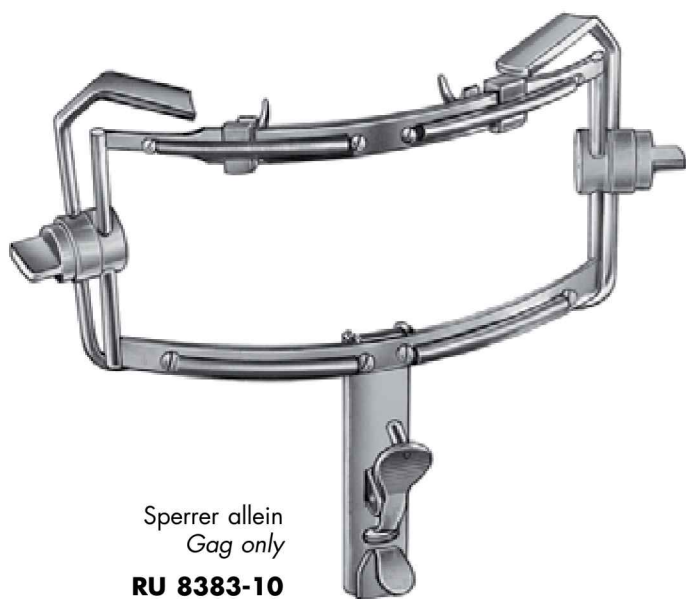

Sperrer allein
Gag only

RU 8383-10

Dingmann

komplett mit
3 auswechselbaren Zungenspateln (Fig. 1 – 3),
2 drehbaren Wangenhaltern,
2 beweglichen Zahnhaken
und Fadenführer

complete with
3 interchangeable tongue blades (Fig. 1 – 3),
2 rotatable cheek holders,
2 movable tooth hooks
and thread guide

RU 8383-00



- Fig. 1 24 x 62 mm **RU 8383-01**
- Fig. 2 28 x 65 mm **RU 8383-02**
- Fig. 3 31 x 75 mm **RU 8383-03**

Zungenspatel
Tongue blades

**MUNDSPERRER
MOUTH GAGS**



Davis-Boyle
für Erwachsene/*for adults*
komplett mit 5 Spateln Fig. 1 – 5
complete with 5 tongue blades Fig. 1 – 5
RU 8384-00

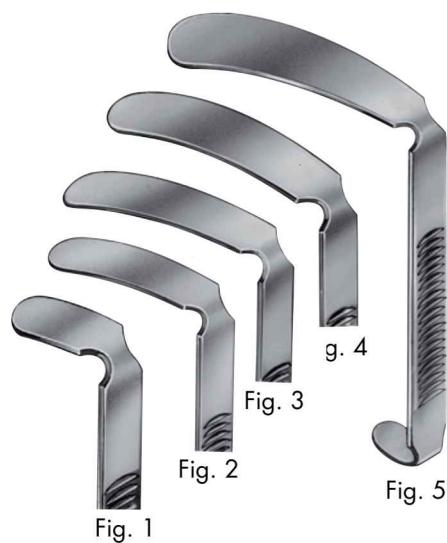

Fig. 1	21 x 30 mm	RU 8384-01
Fig. 2	23 x 65 mm	RU 8384-02
Fig. 3	24 x 80 mm	RU 8384-03
Fig. 4	25 x 93 mm	RU 8384-04
Fig. 5	26 x 108 mm	RU 8384-05

Zungenspatel/*tongue blades*



Sperrer allein
Gag only
RU 8384-14
Davis-Boyle
für Kinder/*for children*
komplett mit 5 Spateln Fig. 1 – 5
complete with 5 tongue blades Fig. 1 – 5
RU 8384-50

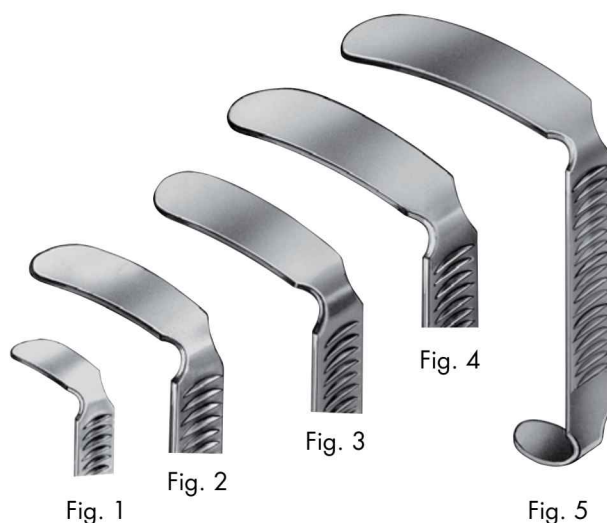

Fig. 1	17 x 26 mm	RU 8384-51
Fig. 2	19 x 46 mm	RU 8384-52
Fig. 3	20 x 58 mm	RU 8384-53
Fig. 4	22 x 71 mm	RU 8384-54
Fig. 5	22 x 80 mm	RU 8384-55

Zungenspatel/*tongue blades*

auswechselbare Silikoneinlagen für beide Sperrer
removable silicon inserts for both gags

RU 8384-99

**MUNDSPERRER, ZUNGENSPEL
MOUTH GAGS, TONGUE BLADES**



Mc Ivor
komplett mit 3 Spateln Fig. 1 – 3
complete with 3 tongue blades Fig. 1 – 3
RU 8386-00



Fig. 1 23 x 70 mm **RU 8386-01**
Fig. 2 25 x 86 mm **RU 8386-02**
Fig. 3 26 x 100 mm **RU 8386-03**
Zungenspatel/tongue blades



Herberhold

Fig. 1 28 x 63 mm **RU 8387-01**
Fig. 2 33 x 73 mm **RU 8387-02**
Fig. 3 37 x 87 mm **RU 8387-03**
Fig. 4 40 x 94 mm **RU 8387-04**

Fig. 2 23 x 65 mm **RU 8388-02**
Fig. 3 24 x 80 mm **RU 8388-03**
Fig. 4 25 x 93 mm **RU 8388-04**
Fig. 5 26 x 108 mm **RU 8388-05**
Fig. 6 26 x 114 mm **RU 8388-06**

Zungenspatel/tongue blades

Modell Würzburg

Fig. 1 28 x 66 mm **RU 8389-01**
Fig. 2 32 x 75 mm **RU 8389-02**
Fig. 3 34 x 83 mm **RU 8389-03**
Fig. 4 37 x 93 mm **RU 8389-04**
Fig. 5 38 x 100 mm **RU 8389-05**

**ZUNGENSPEL, BRUSTSTÜTZE
TONGUE BLADES, CHEST SUPPORT**

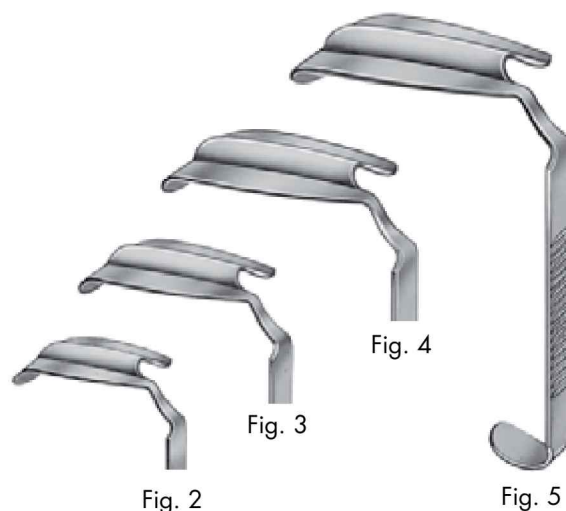
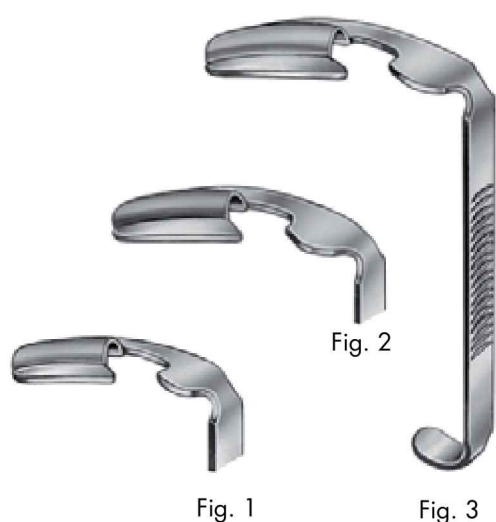

Fig. 1 28 x 65 mm **RU 8389-21**
Fig. 2 32 x 75 mm **RU 8389-22**
Fig. 3 37 x 80 mm **RU 8389-23**

mit seitlichem Einschnitt/*lateral slot*

		links/ <i>left</i>	rechts/ <i>right</i>
Fig. 2	23 x 58 mm	RU 8390-02	RU 8390-52
Fig. 3	27 x 72 mm	RU 8390-03	RU 8390-53
Fig. 4	34 x 87 mm	RU 8390-04	RU 8390-54
Fig. 5	37 x 95 mm	RU 8390-05	RU 8390-55

mit seitlichem Einschnitt/*lateral slot*



**Bruststütze für Mundsperrer
Chest support for mouth gag**

für Erwachsene/ <i>for adults</i>	RU 8395-00
für Jugendliche/ <i>for adolescent</i>	RU 8395-02
für Kinder/ <i>for children</i>	RU 8395-03

Alle auf den Seiten 324-329 abgebildeten Griffe und Spatel sind untereinander austauschbar.
All the frames and blades illustrated on pages 324-329 are interchangeable.

**MUNDSPERRER
MOUTH GAGS**



Baby-Molt
10 cm/4"
RU 8402-10



**Molt
Doyen-Collin**
11 cm/4½" **RU 8402-11**
14 cm/5½" **RU 8402-14**

**Schutzhüllen (Paar) für:
Protecting sleeves (pair) for:**

RU 8402-10 → **RU 8403-10**
RU 8402-11 → **RU 8403-11**
RU 8402-14 → **RU 8403-14**



Roser-König
16 cm/6¼" **RU 8405-16**
19 cm/7½" **RU 8405-19**



Denhart
12 cm/4¾" **RU 8406-12**



Heister
13 cm/5" **RU 8408-13**



Heister
13 cm/5" **RU 8409-13**
mit Teflonauflage
with teflon insert

**MUNDSPERRER
MOUTH GAGS**



Fergusson-Ackland
14,5 cm/5¾" **RU 8410-14**

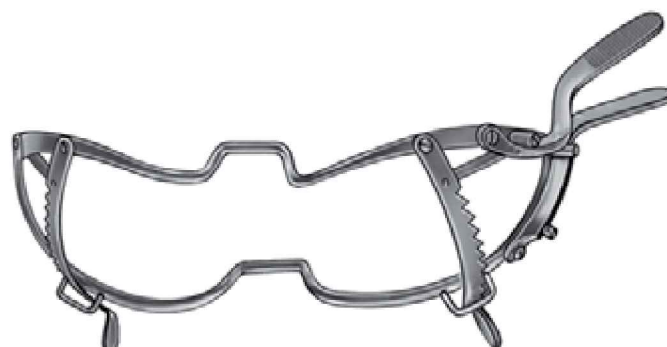

Whitehead
9 cm/3½" **RU 8412-09**
11 cm/4¼" **RU 8412-11**
13 cm/5" **RU 8412-13**
15 cm/6" **RU 8412-15**

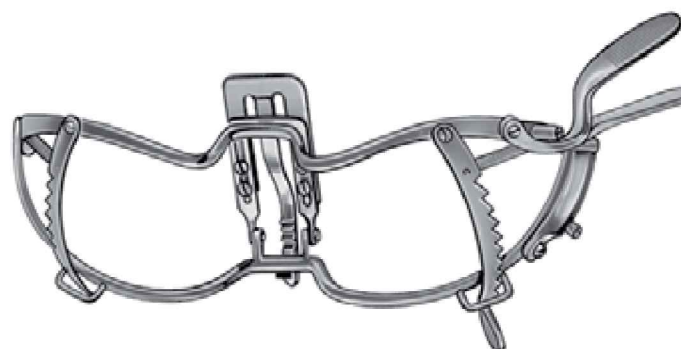

Whitehead
11 cm/4¼" **RU 8414-11**
13 cm/5" **RU 8414-13**



Jennings
RU 8417-00



Jennings
9 cm/3½" **RU 8416-09**
11 cm/4¼" **RU 8416-11**
13 cm/5" **RU 8416-13**
15 cm/6" **RU 8416-15**

MUNDSPERRER, ZUNGENDRÜCKER
MOUTH GAGS, TONGUE DEPRESSORS

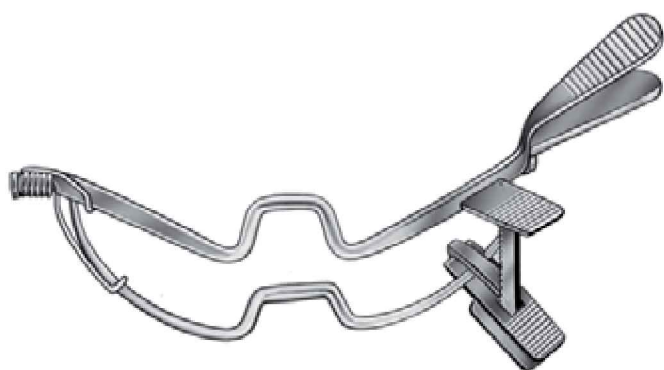

Seemann-Seiffert

9 cm/3½" **RU 8418-09**
11 cm/4¼" **RU 8418-11**
13 cm/5" **RU 8418-13**

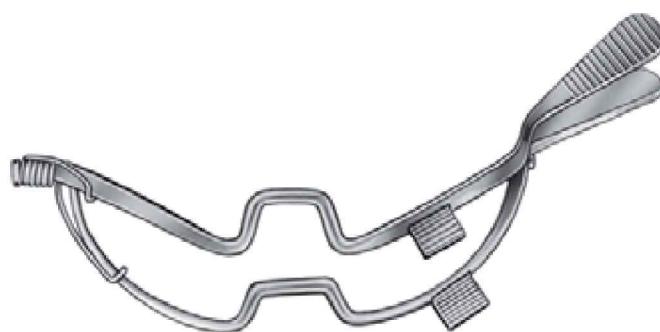

Seemann-Seiffert
Standard

11 cm/4¼" **RU 8419-11**
13 cm/5" **RU 8419-13**



Sternberg

12 cm/4¾" **RU 8421-12**
14 cm/5½" **RU 8421-14**
16 cm/6¼" **RU 8421-16**



Moritz-Schmidt

19 cm/7½"
RU 8424-19

**ZUNGENSPEL
TONGUE DEPRESSORS**



Hartmann
16,5 cm/6½"
RU 8425-15



Tobold
16 cm/6¼"
RU 8426-14



Frenzel
16,5 cm/6½"
RU 8429-16



14,5 cm/5¾"
RU 8430-14



14,5 cm/5¾"
RU 8431-14



Kroenig
15 cm/6"
RU 8432-15



Mayo
17 cm/6¾"
RU 8433-17

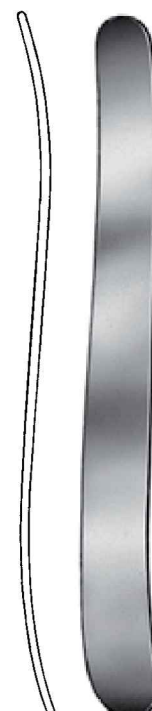

Buchwald
18 cm/7"
RU 8434-18

ZUNGENSPEL, ZUNGENZANGEN, FINGERSCHÜTZER
TONGUE DEPRESSORS, TONGUE HOLDING FORCEPS, FINGER PROTECTORS



Bruenings
19 cm/7½"
RU 8440-19



RU 8442-01 RU 8442-02

Weder

Packung à 100 Stück
package of 100 pcs.



16 cm/6¼"
RU 8445-16
Holzspatel
Wooden spatula



Collin
16 cm/6¼"
RU 8450-16



Young
17 cm/6¾"
RU 8452-17

Paar Gummipolster, allein
Pair of rubber jaws, only

RU 8452-50



Langenbeck
Ø 22 mm **RU 8455-01**
Ø 24,5 mm **RU 8455-02**
Ø 26,5 mm **RU 8455-03**
Fingerschützer
Finger protectors

**TAMPONSTOPFER, TONSILLENNADELN
GAUZE PACKERS, TONSIL NEEDLES**

Tamponstopfer/Gauze packers



Luniatschek
18 cm/7"
RU 8458-01



Luniatschek
18 cm/7"
RU 8458-02



Luniatschek
19 cm/7½"
RU 8544-19



Claus
23 cm/9"
RU 8502-23



Hurd
21 cm/8¼"
RU 8503-01
für rechte Hand
for right hand



Hurd
21 cm/8¼"
RU 8503-02
für linke Hand
for left hand



Nager
24 cm/9½"
RU 8512-24



Yankauer
17 cm/6¾"



RU 8513-01



RU 8513-02

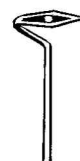

RU 8513-03
für rechte Hand
for right hand

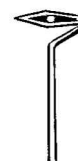

RU 8513-04
für linke Hand
for left hand

**LIGATURINSTRUMENTE
LIGATURE INSTRUMENTS**



Falk
24 cm/9½"
RU 8516-01
für rechte Hand
for right hand

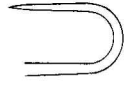
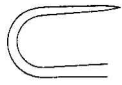

Falk
24 cm/9½"
RU 8516-02
für linke Hand
for left hand



Claus van Eicken
23 cm/9"
RU 8518-23



Claus van Eicken
21 cm/8¼"
RU 8519-21



Roeder
26 cm/10¼"
RU 8520-26

Stärke 0/size 0
RU 8520-50
Stärke 1/size 1
RU 8520-51
Marline Rapit-Schlingen (12 St.)
Marline Rapit snares (12 pcs.)



Negus
20 cm/8"
RU 8524-20

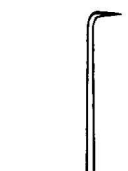

RU 8525-01

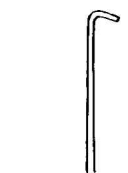

RU 8525-02

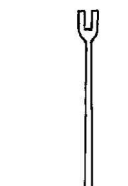

RU 8525-03

20 cm/8"

TONSILLENABSZESSZANGEN, TAMPONZANGEN, TONSILLENMESSER
TONSIL ABSCESS FORCEPS, SPONGE HOLDING FORCEPS, TONSIL KNIVES



Thilenius
20 cm/8"
RU 8529-19

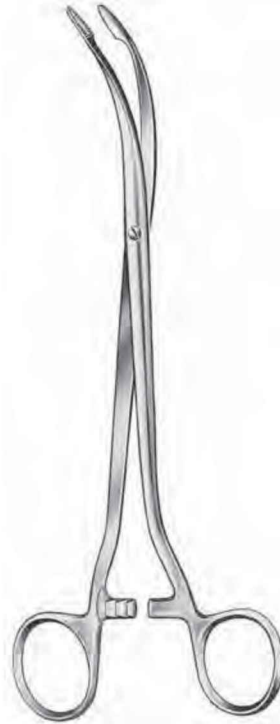

Duplay
19 cm/7½"
RU 8530-19



19 cm/7½"
RU 8531-17



RU 8531-99
Schutzhülse
protective shield



Fischer
22,5 cm/8¾"
RU 8533-22



Fowler
22,5 cm/8¾"
RU 8535-20



Perwitschky
23 cm/9"
RU 8536-22



Vetter
24 cm/9½"
RU 8537-24

**TONSILLENMESSER, ELEVATORIEN
TONSIL KNIVES, ELEVATORS**



Abraham
21 cm/8¼"
RU 8538-21



Bruenings
23 cm/9"
RU 8539-23



Abraham
19 cm/7½"
RU 8540-19



Hurd
22,5 cm/8¾"
8 mm **RU 8542-08**
10 mm **RU 8542-22**

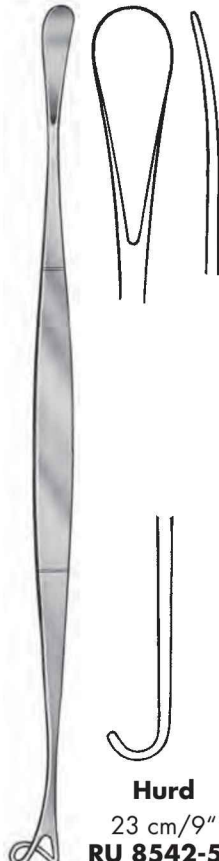

Hurd
23 cm/9"
RU 8542-50



19,5 cm/7¾"
RU 8543-19



22 cm/8½"
RU 8543-50

**ELEVATORIEN
ELEVATORS**

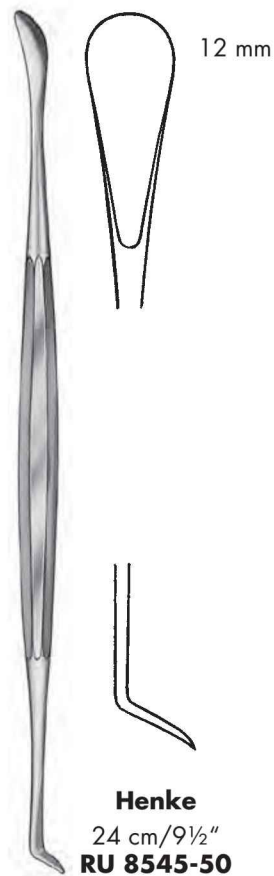
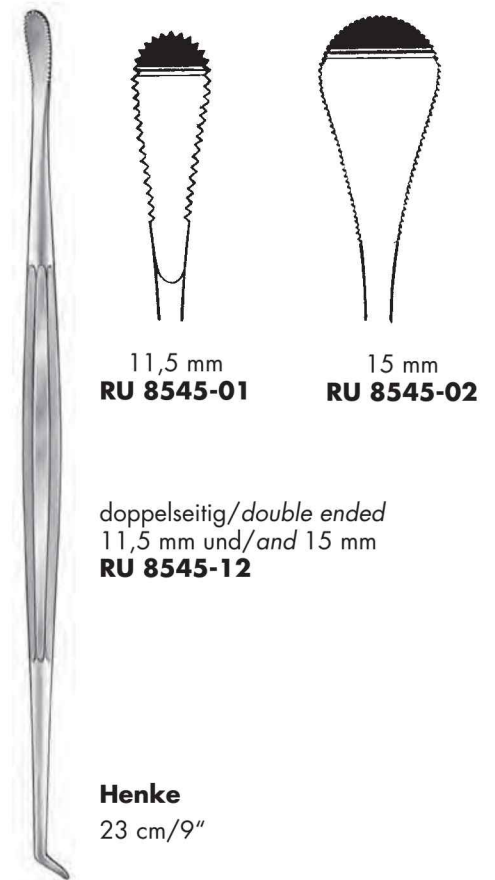
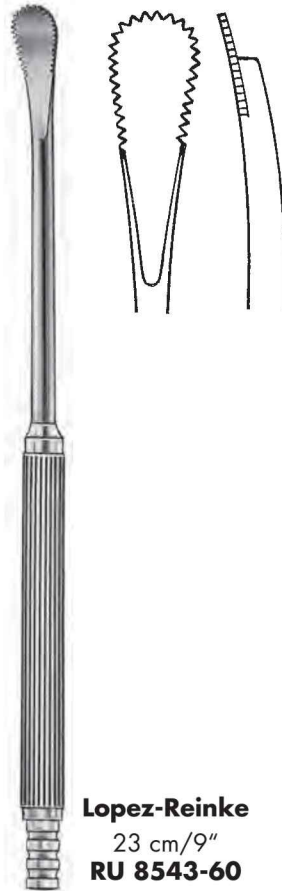
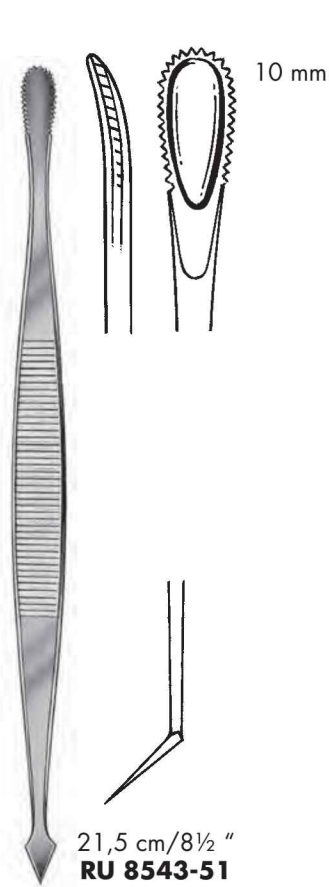

**ELEVATORIEN, TONSILLENFASSZANGEN
DISSECTORS, TONSIL GRASPING FORCEPS**



Haslinger
17 cm/6¾"
RU 8548-16



Hofer
24 cm/9½"
RU 8549-24

4 : 5



5 : 6

Allis
15 cm/6"
Zähne 4:5 RU 6500-15
teeth 5:6 RU 6502-15



Museux
20 cm/8"
gerade/straight RU 8550-20
gebogen/curved RU 8551-20



Ballenger
21,5 cm/8½"
RU 8553-21



White
18 cm/7" RU 8555-18
23 cm/9" RU 8555-23

TONSILLENFASSZANGEN, TONSILLENKLEMMEN
TONSIL GRASPING FORCEPS, TONSIL HEMOSTATIC FORCEPS



Colver
19 cm/7½"
gerade/straight gebogen/curved
RU 8556-19 RU 8557-19



Abraham
20 cm/8"
RU 8559-20



Blohmke
20 cm/8"
RU 8560-20



Schnidt
19 cm/7½"

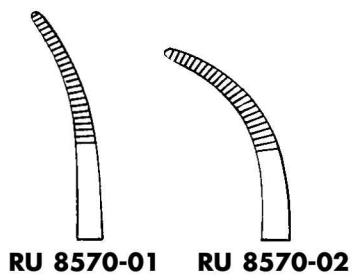

Schnidt
19 cm/7½"

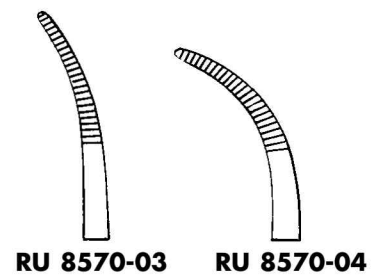

**TONSILLENSCHNÜRER
TONSIL SNARES**



Eves
28 cm/11"
RU 8600-28



Eves
28 cm/11"
RU 8602-28



Bruenings
28 cm/11"
RU 8604-28



Tyding
mit 1 geraden Aufsatz
with 1 straight tip
RU 8608-00



RU 8608-10

gerader Aufsatz allein
straight tip only



RU 8608-11

Veeder-Aufsatz allein
Veeder tip only

**TONSILLENSCHNÜRER
TONSIL SNARES**



Brown
mit 1 geraden Aufsatz
with 1 straight tip
RU 8610-00



Sage
mit automatischer Sperre
with automatic ratchet
RU 8611-00



	12 St./12 pcs.	100 St./100 pcs.
0,3 mm	RU 8609-03	RU 8609-03/00
0,4 mm	RU 8609-04	RU 8609-04/00
0,45 mm	RU 8609-05	RU 8609-05/00
0,5 mm	RU 8609-06	RU 8609-06/00

Schnürerdraht
Snare wire

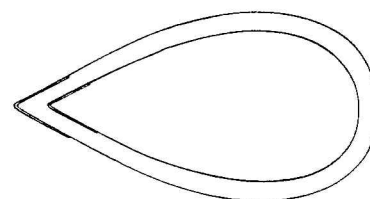

	100 St./100 pcs.
40 mm	RU 8609-40
50 mm	RU 8609-50

Schnürerschlingen
Snare loops

**TONSILLOTOME
TONSILLECTOMES**



Daniels

mit Doppelklinge zum Quetschen und Schneiden
with double blade for squeezing and cutting



Fig. 1
16 mm
RU 8614-01



Fig. 2
20 mm
RU 8614-02



Fig. 3
24 mm
RU 8614-03



Fig. 1
24 mm
RU 8615-01



Fig. 2
26 mm
RU 8615-02



Fig. 3
29 mm
RU 8615-03

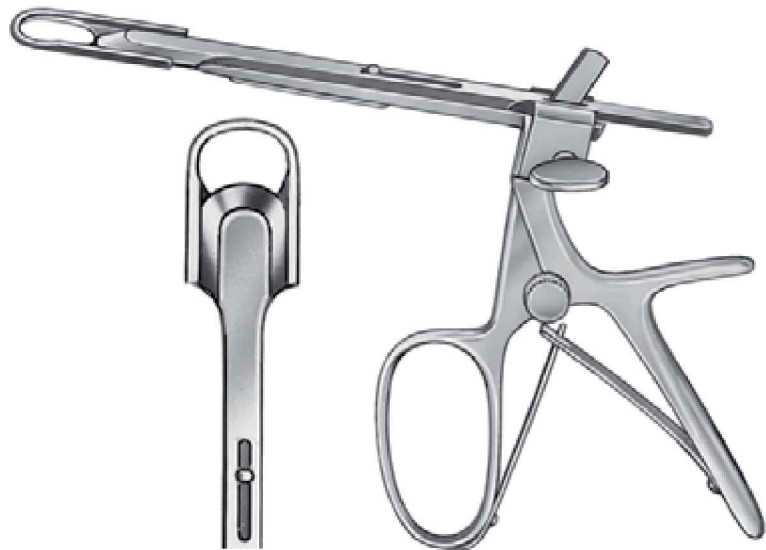

Sluder-Ballenger

komplett mit 3 Aufsätzen (Fig. 1 – 3)
complete, with 3 tips (Fig. 1 – 3)
RU 8615-00

RU 8615-10

Griff allein
Handle only

— Aufsätze, allein/Tips only —

**TONSILLEN-CONCHOTOME, TONSILLENKOMPRESSORIUM
TONSIL PUNCHES, TONSIL COMPRESSOR**



Hartmann

- Ø 13 mm **RU 8616-13**
- Ø 15 mm **RU 8616-15**
- Ø 17 mm **RU 8616-17**

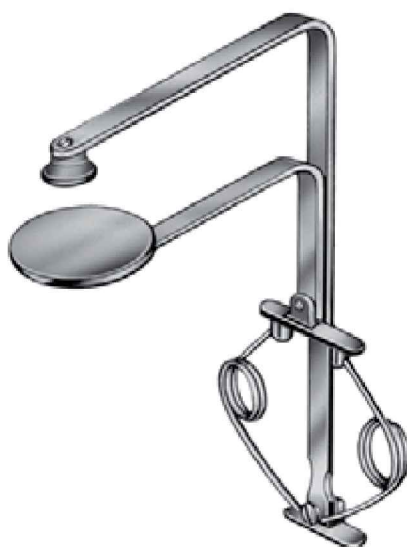

Vetter

RU 8617-50